

APPENDIX F

ESSENTIAL FISH HABITAT REPORT

(Includes previous Appendix D - Stream Habitat Mitigation Plan)

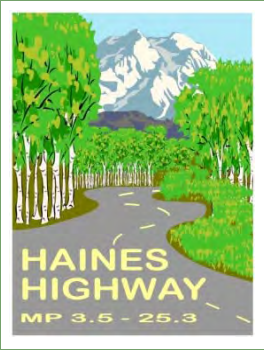

HAINES HIGHWAY

FROM MP 3.5 TO MP 25.3

HAINES, ALASKA



ESSENTIAL FISH HABITAT ASSESSMENT

AUGUST 2014

DOT&PF Project No. 68606
FEDERAL Project No. SHAK-095-6(28)





UNITED STATES DEPARTMENT OF COMMERCE
National Oceanic and Atmospheric Administration

National Marine Fisheries Service

P.O. Box 21668

Juneau, Alaska 99802-1668

September 18, 2014

Jane Gendron
Southeast Region Environmental Program Manager
Alaska Department of Transportation and Public Facilities
P. O. Box 112506
Juneau, Alaska 99811-2506

RE: Haines Highway MP 3.5 – 25.3
State/Federal Project No. 68606/SHAK-095-6(28)
Revised Final Essential Fish Habitat Assessment August 2014

Dear Ms. Gendron:

The National Marine Fisheries Service (NMFS) has reviewed the *Revised Draft Essential Fish Habitat Assessment Haines Highway from MP 3.5 to MP 25.3 Haines, Alaska* dated August 2014. The purpose of the project is to address highway deficiencies, bridge deficiencies, highway instability, and recreational access deficiencies. Achieving the project purpose would be accomplished by straightening most curves and increasing sight distances, providing wider shoulders, modifying the current design speed, and replacing the existing Chilkat River Bridge.

Section 305(b)(2) of the Magnuson-Stevens Fishery Conservation and Management Act, requires all federal agencies to consult with the Secretary of Commerce on all actions or proposed actions authorized, funded, or undertaken by the agency that may adversely affect Essential Fish Habitat (EFH). EFH is designated in Alaska for species managed under specific Federal Fishery Management Plans. Within the project area, EFH for five species of Pacific salmon (Chinook, chum, coho, pink, and sockeye) has been designated. Various life stages of these species use the Chilkat River and its tributaries.

NMFS has previously provided comments and EFH Conservations Recommendations for this project. NMFS acknowledges that the Alaska Department of Transportation and Public Facilities has designed the project to minimize impacts to EFH, and taken measures to mitigate impacts to EFH while still meeting the project objectives. The mitigation outlined in the August 2014 EFH Assessment is responsive to NMFS's EFH recommendations. Therefore, NMFS considers EFH consultation for the project to be complete.



If you have any questions concerning our comments on this project, please direct them to Cindy Hartmann Moore at Cindy.Hartmann@noaa.gov, or at (907) 586-7585.

Sincerely,

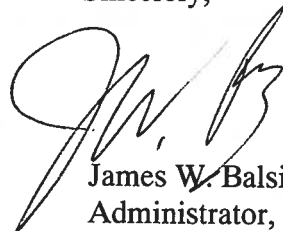
A handwritten signature in black ink, appearing to read 'J. W. Balsiger', written over a light grey background.

James W. Balsiger, Ph.D.
Administrator, Alaska Region

cc: Cindy Hartmann Moore, HCD
Jeanne Hanson, HCD
Neil Stichert, FWS, Juneau
Kate Kanouse, ADF&G, Juneau
Jackie Timothy, ADF&G, Juneau
Jim Scholl, ADOT&PF, Juneau
Randy Vigil, USACE, Juneau

References

- Dolat, S.W. 1997. Acoustic measurements during the Baldwin Bridge Demolition (final, dated March 14, 1997). Prepared for White Oak Construction by Sonalysts, Inc., Waterford, CT. 34 pp plus appendices.
- Jemison, L. A., G.W. Pendleton, L.W. Fritz, K. K. Hastings, J. M. Maniscalci, A. W. Trites and T. S. Gelatt. 2013. Inter-Population Movements of Steller Sea Lions in Alaska with Implications for Population Separation. PLOS One 8, 14p.
- National Marine Fisheries Service. 2005. Final Environmental Impact Statement, Essential Fish Habitat Identification and Conservation in Alaska, Vol. 2, Appendix G; National Marine Fisheries Service, Department of Commerce. April, 2005.
- Rogers, P.H. and M. Cox. 1988. Underwater sound as a biological stimulus. pp. 131-149. *In* Sensory biology of aquatic animals. Atema, J, R.R. Fay, A.N. Popper, and W.N. Tavolga, eds. Springer-Verlag. New York.



THE STATE
of **ALASKA**
GOVERNOR SEAN PARNELL

Department of Transportation
and Public Facilities

SOUTHEAST REGION
DESIGN & ENGINEERING SERVICES
Preconstruction

6860 Glacier Highway
PO Box 112506
Juneau, Alaska 99811-2506
Main: 907.465.4444
Toll free: 877.305.6630
Fax: 907.465.4414

August 16, 2014

Cindy Hartmann Moore
US Department of Commerce, National Oceanic and Atmospheric Administration
National Marine Fisheries Service
POB 21668
Juneau, AK 99802-1668

RE: Haines Highway MP 3.5 to 25.3
State/Federal Project No. 68606/SHAK-095-6(28)
Revised Final Fish Habitat Assessment

Dear Ms. Moore:

Thank you for your careful review and comment of the Revised Essential Fish Habitat (EFH) assessment. In particular, we appreciate the help in assessing appropriate avoidance, minimization, and mitigation measures.

As you know, after all measures to avoid and minimize impacts to EFH, and in particular wetlands, we propose to create and/or enhance fish bearing tributaries of the Chilkat River. In a perfect world we could quantify the value of the impacted wetlands functions and a corresponding functional improvement from tributary creation. In fact, we have attempted to do so (see the "Wetland Stream Functions" report at http://dot.alaska.gov/sereg/projects/haines_hwy/documents.shtml). However, there is no approved method of evaluating the function and values of riverine areas. As a result there is no approved method to evaluate the the functional lift gained from the tributaries we propose to create/enhance.

Over the years, we have relied on the advice and expertise of the Inter-Disciplinary Team (IDT), including NMFS, to give us advice and guidance on how best to develop an acceptable mitigation plan. In other words, in the absence of an approved functional assessment method for riverine areas, we have relied on professional opinion. Recently, we relied on advice from Alaska Fish and Game (ADF&G) biologists, based in Haines, to develop Chilkat River mitigation the mimics existing Chilkat River fish habitat.

"Keep Alaska Moving through service and infrastructure."

We have updated Tables 2, and created Tables 2a, and 2b to quantify (as best as we can) in tabular form, the impacts to wetlands, and the benefits from offsetting stream creation/enhancements.

Correspondingly, we have updated Tables 3 and created Table 3a to quantify (as best as we can) in tabular form, the impacts to the Chilkat River, and the benefits from offsetting in-river mitigation.

We have added the information to the EFH Assessment to improve the mitigation analysis and, as requested, are submitting the body of the EFH (attached). We have also attached pertinent correspondence from ADF&G evaluating mitigation opportunities. Thank you again for working with us to improve the analysis of mitigation. We believe the EFH assessment is final. Please confirm consultation is complete.

Sincerely,

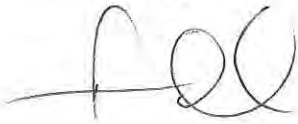
A handwritten signature in black ink, appearing to read 'J Scholl', with a stylized flourish at the end.

Jim Scholl,
Project Environmental Coordinator

Enclosures:

1. Revised Final ESH Assessment w/o Appendices
2. June 6, 2014 e-mail from Kate Kanouse, ADF&G to James Scholl, DOT&PF
3. May 2014 ADF&G Trip Report dated June 27, 2014
4. July 2014 ADF&G Trip Report, dated August 15, 2014

Cc: James Balsinger, Ph.D, NMFS
Neil Stichert, FWS, Juneau
Jackie Timothy, ADF&G, Juneau
Randy Vigil, USACE

**ESSENTIAL FISH HABITAT ASSESSMENT
HAINES HIGHWAY FROM MP 3.5 TO MP 25.3
HAINES, ALASKA**

**DOT&PF Project No. 68606
Federal Project No. SHAK-095-6(28)**

Prepared for:

United States Department of Transportation
Federal Highway Administration, Alaska Division
709 West 9th Street, Room 851
Juneau, Alaska 99802

&

The Alaska Department of Transportation and Public Facilities,
Southeast Region
6860 Glacier Highway
Juneau, Alaska 99801

Prepared by:

DOWL HKM
4041 B Street
Anchorage, Alaska 99503
(907) 562-2000

&

The Alaska Department of Transportation and Public Facilities,
Southeast Region
6860 Glacier Highway
Juneau, Alaska 99801

August 2014

TABLE OF CONTENTS

1.0	INTRODUCTION	1
2.0	REVISED PROPOSED ACTION	1
2.1.1	Revised Proposed Action.....	4
2.1.2	Improvements to Haines Highway.....	4
2.1.3	Replacement of Chilkat River Bridge.....	4
2.1.4	Improvements for Highway Protection at Debris and Water Flood Flow Areas	5
2.1.5	Improvements for Recreational Areas	5
3.0	ANALYSIS OF EFFECT ON ESSENTIAL FISH HABITAT	12
3.1	Highway Alignment Considerations Concerning Impacts to EFH.....	12
3.1.1	Embankment Considerations	12
3.1.2	Drainage Considerations	13
3.1.3	Highway Safety Considerations.....	13
3.1.4	Chilkat River Bridge Design Considerations.....	14
3.2	Chilkat River and Tributary Conditions	14
3.2.1	EFH Species Present in Project Area.....	15
4.0	PROJECT EFFECTS ON ESSENTIAL FISH HABITAT.....	19
4.1	Construction (Short-Term) Effects	19
4.2	Operational (Long-Term) Effects	19
4.2.1	Impacts to EFH Wetlands and Mitigation	19
4.2.2	Impacts to the Chilkat River and Mitigation.....	24
4.2.3	Direct Impacts to Chilkat River Tributaries and Mitigation.....	32
4.3	Avoidance and Minimization Measures	34
4.3.1	Avoidance	34
4.3.2	Minimization.....	34
5.0	PROPOSED CONSERVATION MEASURES.....	38
6.0	AGENCY CONSULTATION	39
7.0	AGENCY DETERMINATION.....	39
8.0	REFERENCES	41

FIGURES

Figure 1: Project Location and Vicinity Map	3
Figure 2: Existing Typical Section	6
Figure 3: Proposed Typical Section.....	7
Figure 4: Proposed Typical Section with Guardrail	8
Figure 5: Proposed Chilkat River Bridge Location	9
Figure 6: Proposed Debris Flow Culvert	10
Figure 7: New Mount Ripinski Trailhead Turnout	11
Figure 8: Woody Debris Upstream and Adjacent to Large Rocks	29
Figure 9: Vegetated River Protrusion	30
Figure 10: Fish Wheel Site	31
Figure 11: Proposed Bridge Concept versus Existing Bridge	37

TABLES

Table 1: Essential Fish Habitat.....	17
Table 2: EFH Wetland Impacts for Entire Project (Acres).....	20
Table 2a: Mitigation for EFH Wetland Impacts - EFH Stream Creation/Enhancements.....	21
Table 2b: Mitigation for EFH Wetland Impacts – Proposed Fish Passage Culverts	22
Table 3: Impacts to the Chilkat River	25
Table 3a: In-River Mitigation for Impacts to the Chilkat River	26
Table 3b: Class III Riprap.....	28
Table 3c: Class IV Riprap.....	28
Table 4: Direct Impacts in Chilkat River Tributaries (Lineal Feet).....	33
Table 4a: Mitigation for Direct Impacts to Chilkat River Tributaries (Lineal Feet).....	33
Table 5: Chilkat River In-Water Work by Location.....	36

APPENDICES

Appendix A.....	EFH Impacts
Appendix B.....	Stream and Habitat Inventory (available on attached CD)
Appendix C.....	Hydrology and Hydraulics Report (available on attached CD)
Appendix D.....	Stream Habitat Mitigation Plan
Appendix E.....	Proposed Culvert Upgrades
Appendix F.....	Bank Stabilization Measures
Appendix G.....	King and Coho Smolt Distribution in the Chilkat River

LIST OF ACRONYMS

ADF&G.....	State of Alaska Department of Fish and Game
APDES.....	Alaska Pollutant Discharge Elimination
BMPs.....	Best Management Practices
DEC.....	State of Alaska Department of Environmental Conservation
DNR.....	State of Alaska Department of Natural Resources
DOT&PF.....	State of Alaska Department of Transportation and Public Facilities
EA.....	Environmental Assessment
EFH.....	Essential Fish Habitat
FHWA.....	Federal Highway Administration
HMCP.....	Hazardous Materials Control Plan
IDT.....	Interdisciplinary Team
MP.....	Milepost
mph.....	miles per hour
NMFS.....	National Marine Fisheries Service
Preserve.....	Alaska Chilkat Bald Eagle Preserve
ROW.....	Right-of-Way
SWPPP.....	Stormwater Pollution Prevention Plan
U.S.....	United States
USACE.....	United States Army Corps of Engineers
USCG.....	United States Coast Guard
USFWS.....	United States Fish and Wildlife Service

1.0 INTRODUCTION

In 1996, Congress added new habitat provisions to the Magnuson-Stevens Fishery Conservation and Management Act, the federal law that governs U.S. marine fisheries management. Under the Magnuson-Stevens Act, each fishery management plan must describe and identify Essential Fish Habitat (EFH) for the fishery, minimize to the extent practicable the adverse effects of fishing on EFH, and identify other actions to encourage the conservation and enhancement of EFH. Federal agencies must consult with the National Marine Fisheries Service (NMFS) regarding any action they authorize, fund, or undertake that may adversely affect EFH, and the NMFS must provide conservation recommendations to federal and state agencies regarding any action that would adversely affect EFH.

EFH in Alaska is identified in Fishery Management plans developed by the North Pacific Fishery Management Council and approved by the Secretary of Commerce. Identification of EFH pertinent to the proposed action is given in the Fishery Management Plan “Alaska Stocks of Pacific Salmon” (National Oceanic and Atmospheric Administration (NOAA) Fisheries, <http://alaskafisheries.noaa.gov/habitat/efh/regs.htm>). Wetlands have been identified as important functioning elements of fish habitat and are shown in this assessment for information only.

This EFH assessment has been prepared to aid in consultation with the NMFS.

2.0 REVISED PROPOSED ACTION

The State of Alaska Department of Transportation and Public Facilities (DOT&PF), in coordination with the Federal Highway Administration (FHWA), is proposing a project to upgrade Haines Highway to 55 mile-per-hour (mph) design standards from Milepost (MP) 3.5 to MP 25.3 (Figure 1).

Haines Highway, a designated scenic byway, connects the communities of Haines, Alaska, and Haines Junction, Yukon Territory. This highway is one of two major highways in and out of the Southeast Alaska region and is also an important link in the international transportation system because it connects the Alaska Marine Highway System at Haines with Canada.

Haines Highway was originally constructed in 1943 and has been periodically upgraded over the years, with the portion from the Bluffs (MP 25.3) to the Canadian border (MP 40) being the most recently completed. During this most recent project, the design speed for Haines Highway was designated at 55 mph to make the United States (U.S.) and Canadian portions of the highway consistent.

The purpose of this project is to address:

1. highway deficiencies between MP 3.5 and MP 25.3 and bring the highway up to current design standards for a 55-mph design speed, as practicable, so it is consistent with the adjacent highway segments,
2. bridge deficiencies,
3. highway instability caused by debris and water flooding, and

4. recreational access deficiencies.

Achieving the project purpose would be accomplished by straightening most curves and increasing sight distances, providing wider shoulders, and matching the design speed between MPs 3.5 to 25.3 to the design standards that exist for the remainder of the Haines Highway. In addition, the DOT&PF is proposing to replace the existing Chilkat River Bridge (also known as the Wells Bridge) and address highway stability concerns from debris flows near MPs 19 and 23.

Due to public and agency comment received, the proposed action has been modified to reduce impacts to essential fish habitat (See Appendix A, Figure Set 1). The revised proposed action has reduced the amount of passing zones proposed in the draft Environmental Assessment, July 2013, and reintroduced highway curvature to reduce impacts to the most environmentally sensitive areas (See EFH Figure Set 1).

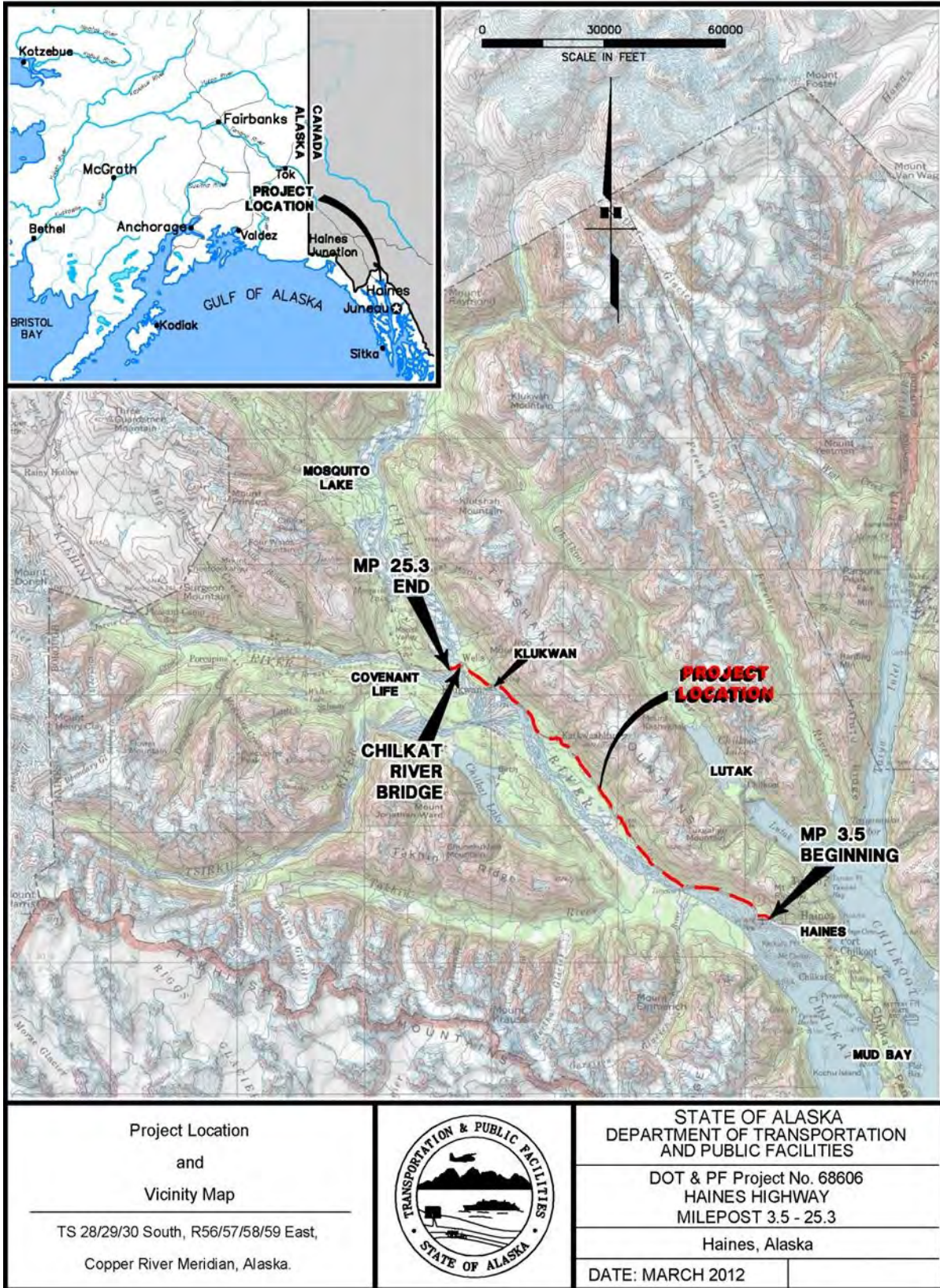

Figure 1: Project Location and Vicinity Map

2.1.1 Revised Proposed Action

The Revised Proposed Action would include the components described below.

2.1.2 Improvements to Haines Highway

- a. Realign sections of the highway and straighten most curves to meet design standards with the exception of two curves. Curves in the vicinity of MP 13 would not be straightened to avoid sensitive resources.
- b. Add passing zones¹.
- c. Widen the roadway shoulders to a continuous six-foot width and provide minimum sight distance to meet design standards (Figures 2 through 4).
- d. Construct drainage ditches and upgrade, replace, and/or add new culverts where appropriate.
- e. Repave and restripe the roadway and add new signage.
- f. Rehabilitate or relocate driveways, turnout access points, and road intersections (including Chilkat Avenue, Klukwan), to meet design standards.
- g. Install or upgrade guardrails and other safety features along the highway where needed (Figure 4).
- h. Modify the Haines-Fairbanks Pipeline Gate Valve 4's surrounding concrete vault to protect the gate valve and provide a safe road embankment.
- i. Acquire approximately 26 acres of ROW.
- j. Relocate utilities where required. Maintain access to utilities not relocated.

2.1.3 Replacement of Chilkat River Bridge

- a. Install a temporary bridge downstream to be used as a construction staging platform.
- b. Construct a new bridge directly adjacent to and downstream of the existing bridge with the same lane and shoulder widths as the proposed road (See Figure 5). The new bridge would be constructed to meet the following criteria:
 - i. a 55-mph design speed,
 - ii. current seismic standards, and

¹ A passing zone is an area on the highway route where the roadway geometry and sight distance permits faster vehicles to overtake slower vehicles in the lane normally used by opposing traffic. Dashed yellow centerline markings indicate where passing is permitted on two-lane, two-way roadways. Personal communication Pat Carroll, P.E., DOT&PF to Jane Gendron, DOT&PF Environmental Impact Manager, May 20, 2013.

iii. provide for a design life of 75 years.

- c. Remove existing bridge deck and rail and cut and remove foundation structures including remnant pilings from previous bridge structures.

2.1.4 Improvements for Highway Protection at Debris and Water Flood Flow Areas

- a. Raise the grade of the highway from its current elevation 15 to 18 feet at MP 19 and MP 23.
- b. Install four to six larger diameter culverts, each at debris flow area near MP 19 and MP 23 (See Figure 6).

2.1.5 Improvements for Recreational Areas

- a. Widen the roadway shoulders from two feet to six feet to improve bicycle capacity.
- b. Construct parking area for access to the Mount Ripinski Trailhead (See Figure 7).
- c. Improve surfacing and grading of turnouts within ROW.

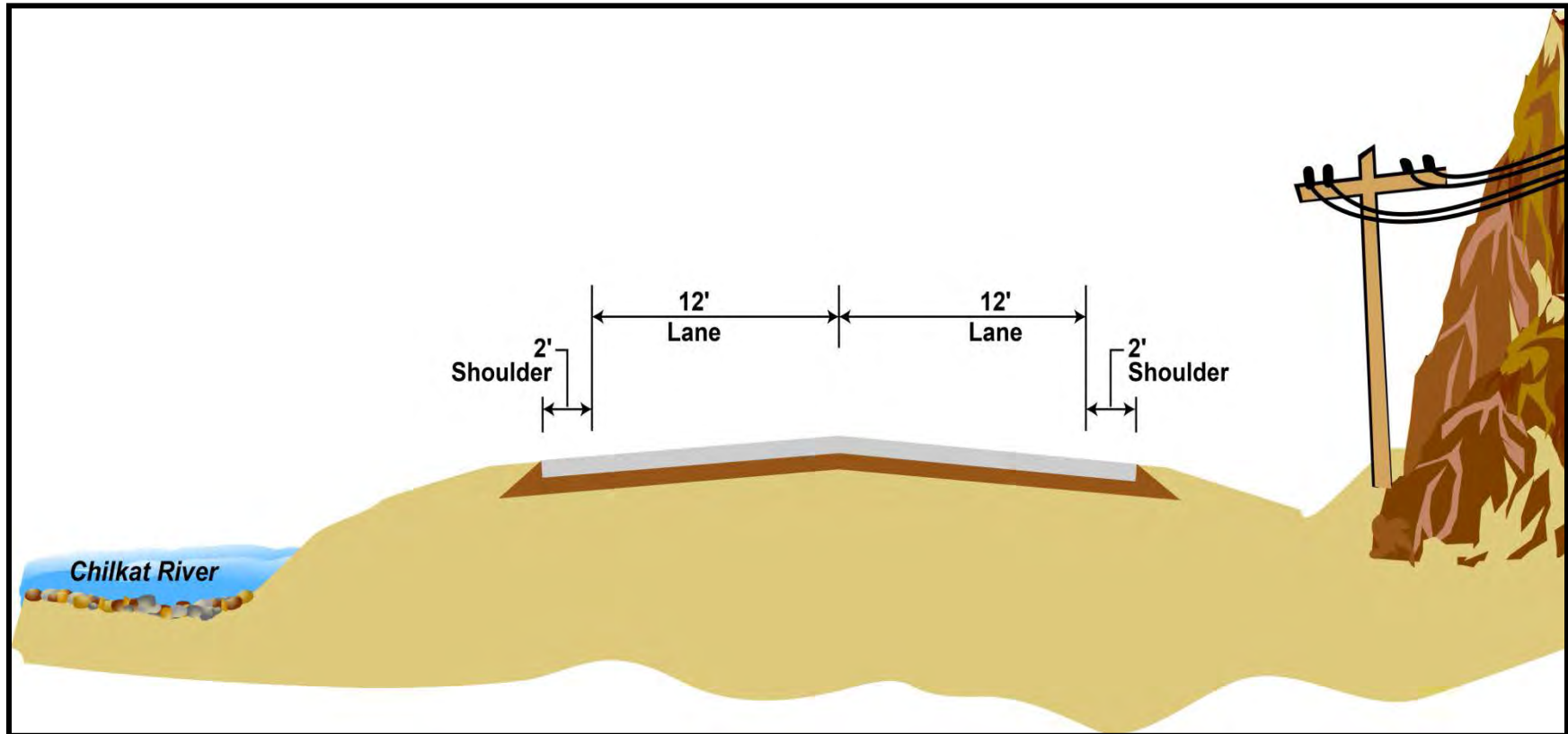

Figure 2: Existing Typical Section
(not to scale)

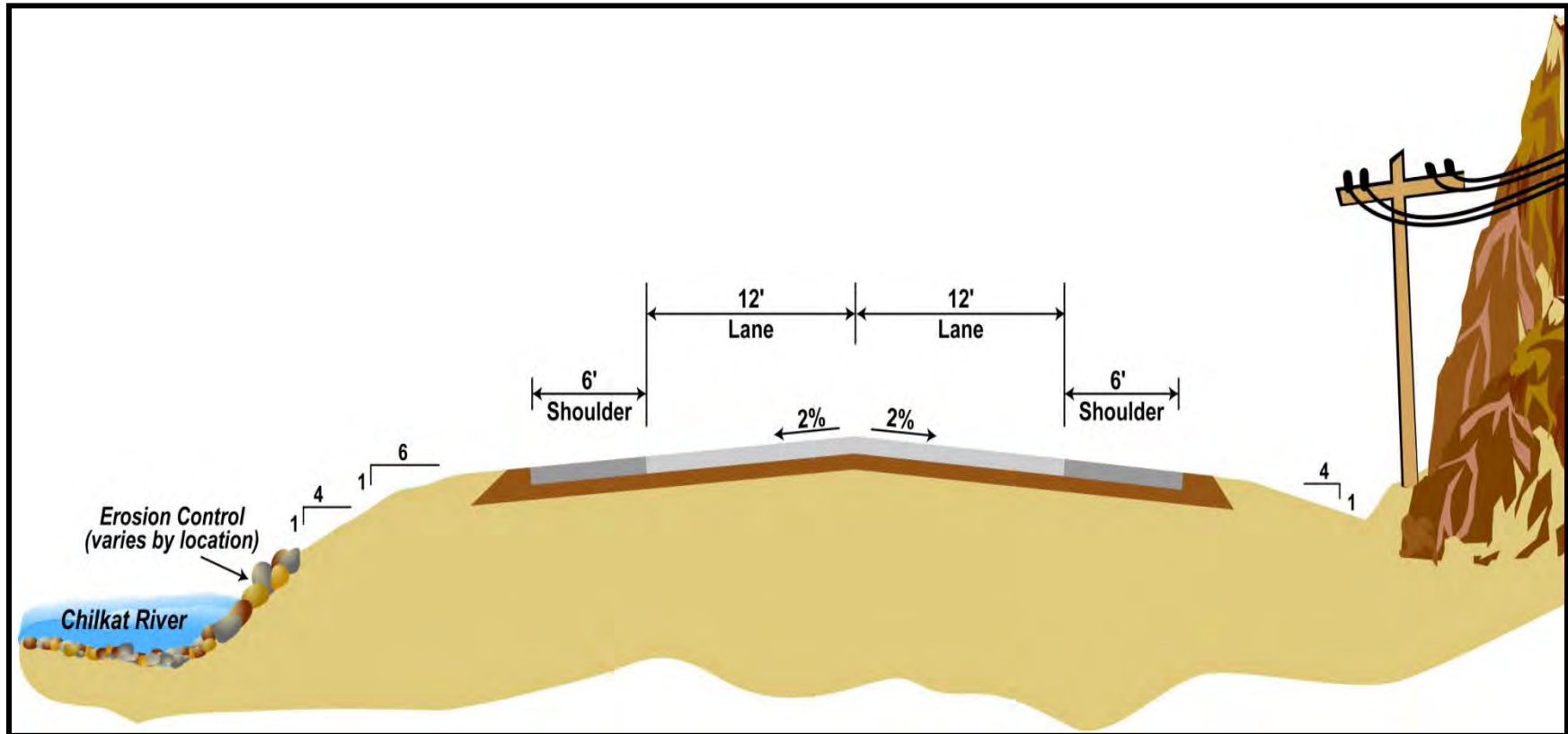

Figure 3: Proposed Typical Section
(not to scale)

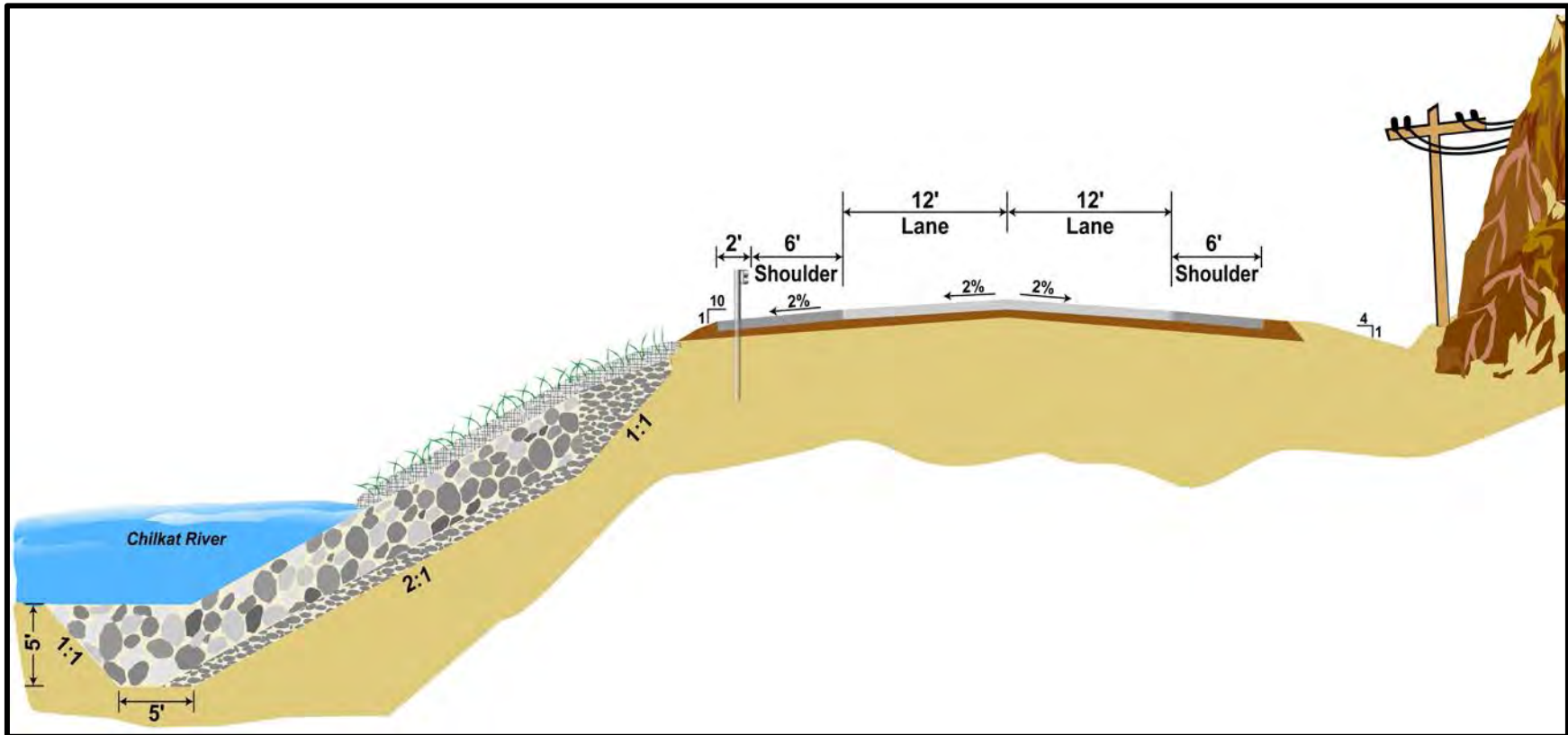

Figure 4: Proposed Typical Section with Guardrail
(not to scale)

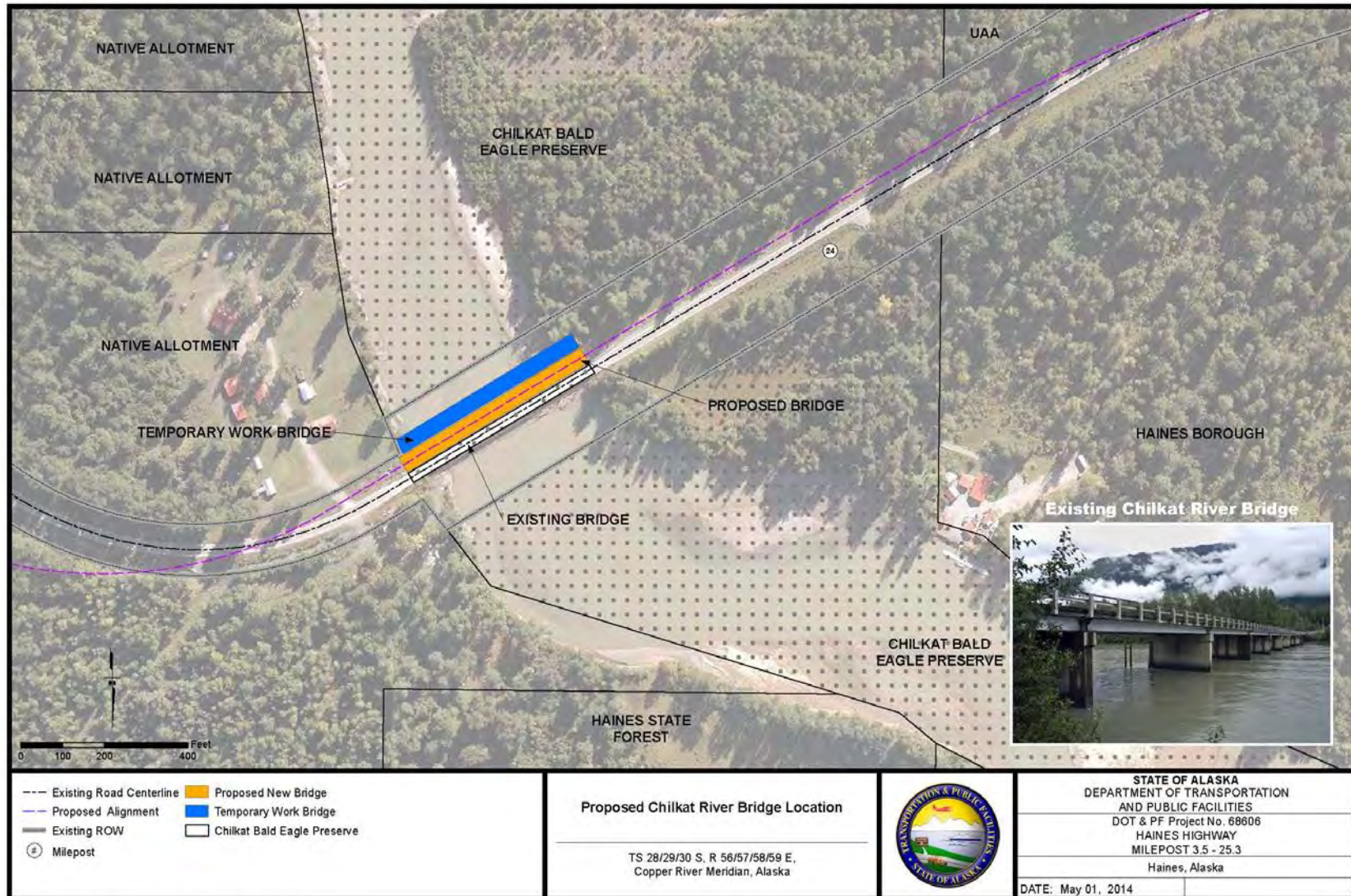

Figure 5: Proposed Chilkat River Bridge Location

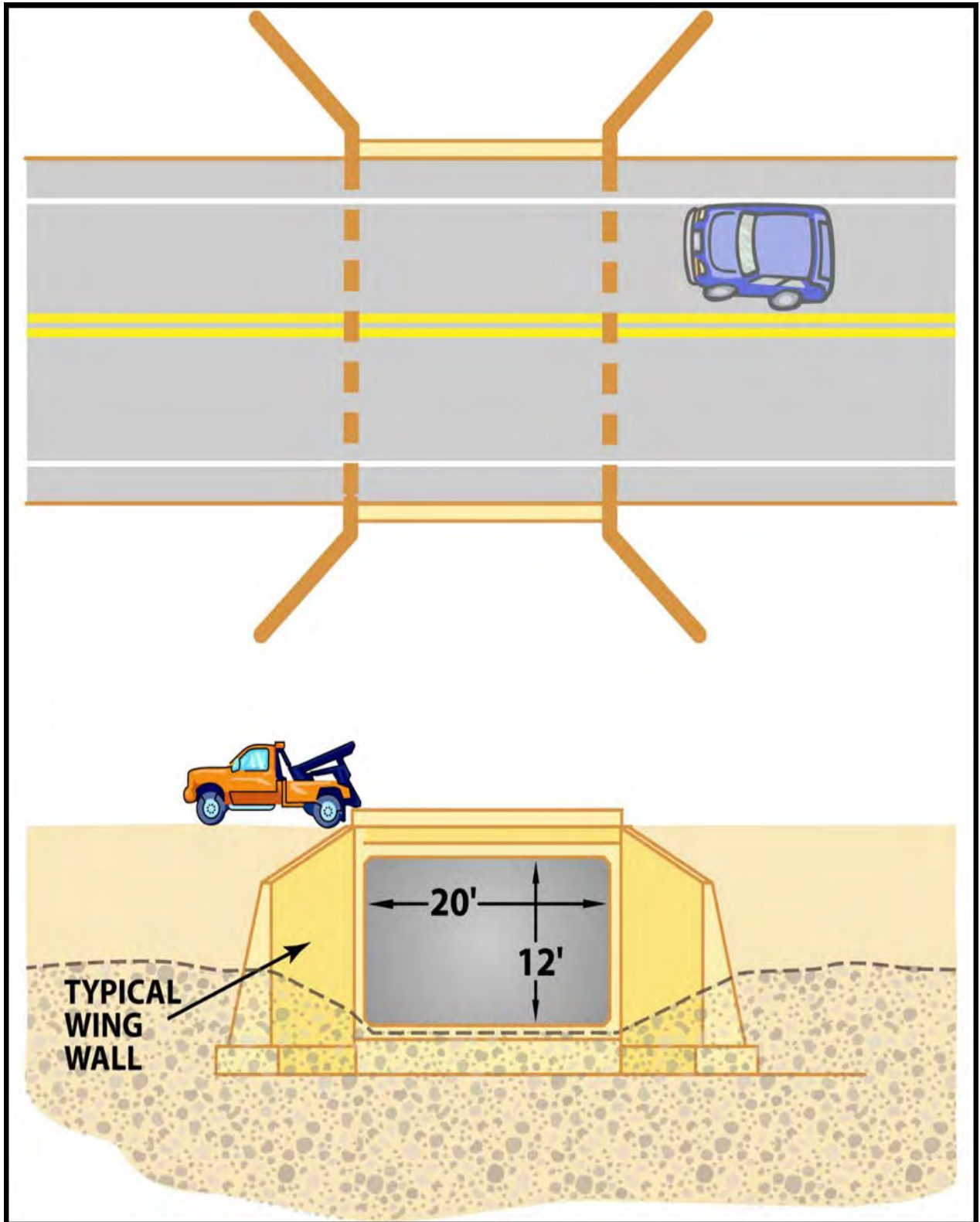

Figure 6: Proposed Debris Flow Culvert
(not to scale)

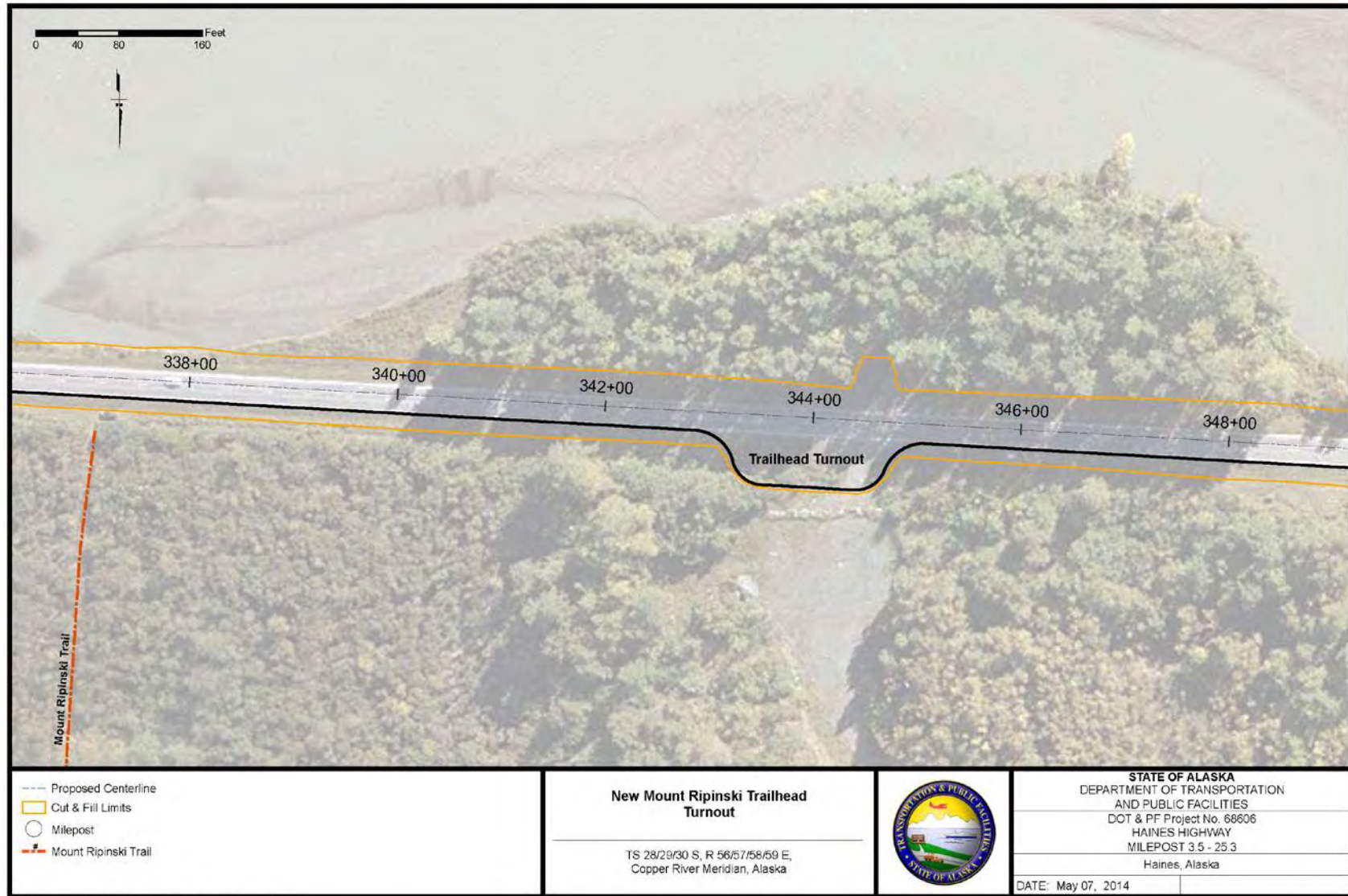

Figure 7: New Mount Ripinski Trailhead Turnout

3.0 ANALYSIS OF EFFECT ON ESSENTIAL FISH HABITAT

Essential Fish Habitat (EFH), as established by the 1996 reauthorization of the Magnuson-Stevens Fishery Conservation and Management Act and the Department of Commerce EFH Consultation Regulations, includes all anadromous fish streams and other protected marine species managed by the Act. EFH is defined in the Act as “those waters and substrate necessary to fish for spawning, breeding, feeding, or growth to maturity.” The components of the proposed project that would affect EFH are as follows:

- placement of fill in the Chilkat River and its tributaries to upgrade the road to a 55-mph design speed, including straightening curves, improving sight distance, and increasing the road shoulder;
- some affected tributaries would be realigned and/or enhanced;
- closure of two highway turnouts where there have been impacts to wetland and riverine habitat from off-road vehicle use and unregulated dumping;
- proposed culvert replacements;
- installation of a temporary bridge to be used as a construction-staging platform;
- construction of a new bridge down river of the existing bridge with same typical section as the road;
- removal of existing bridge superstructure (deck) and cutting and removal of pilings at the river bottom;

3.1 Highway Alignment Considerations Concerning Impacts to EFH

3.1.1 Embankment Considerations

River bank stabilization is required to protect critical transportation infrastructure associated with the Haines Highway from erosional effects of the Chilkat River and its subsidiary channels. River bank revetments along critical infrastructure are required to be designed and installed to meet the most demanding protection requirement that the bank will experience, whether the river is currently adjacent to critical infrastructure or not. Being an extremely dynamic river, any bank stabilization protection/habitat enhancement structure installed today may not be fully utilized for its intended purpose tomorrow.

With respect to bank stabilization efforts and their intended long term function, such efforts, at any given location within the Chilkat River system, are subject to the uncontrollable dynamics and complexities of the fluvial system. Such structures may be ‘online’ for one year, or many years, and likewise may become ‘offline’ for short or long durations in the future. Likewise, fish habitat enhancements added adjacent to the highway bank infrastructure may be within the river flow patterns or not, depending on river dynamics. Riprap would be used to protect a wide range of infrastructure types exposed to the erosional effects of the Chilkat River. Simultaneously, habitat enhancement can be achieved by varying bank geometries, placement of large rock materials and rock/weir/spurs, and the incorporation of strategically placed wood debris within the confines of stable bank protection structures.

The type of structure considered and ultimately used to stabilize the river bank, requires hydraulic and biologic characterization of the site (Trousil, 2013, See Appendix F).

3.1.2 Drainage Considerations

The ADF&G Fish Resource Monitor (January 2014) shows there are 13 existing culverts which “likely impact” and 4 existing culverts which “may impact” fish passage within the project extent. Such barriers could lead to reduced escapements, reduced productivity, and reduced opportunities for subsistence, recreational, and commercial fishers. Larger channel-spanning culverts would be designed to let juvenile salmon move unimpeded among important rearing habitat. All culverts within the project area, including the 13 previously mentioned, would be evaluated for fish passage (DOT&PF, ADF&G, 2001). Preliminary design indicates 26 existing culverts would be replaced with new fish passage culverts in 25 fish-bearing streams on the anadromous waters catalog (AWC) and one fish bearing stream not yet on the AWC, as shown in Appendix A, Figure Set 1 and Table 2b..

3.1.3 Highway Safety Considerations

The Haines Highway closely follows the Chilkat River for portions of the highway alignment. In order to achieve the goals of this project, the alignment would be modified to reduce curves and increase sight distances.

Curves would be reduced in two ways:

- The apparent crest of vertical curves would be reduced so vehicle drivers could see farther over the upcoming hill.
- Horizontal curves would be straightened for a number of safety related issues. One of those issues is to increase sight distance so vehicle drivers could see oncoming traffic, pedestrians, and wildlife from a farther distance.

The current lack of passing areas on this segment of the highway contributes to accidents. This segment currently has restrictions on passing, along approximately 68% of its length (personal communication, S. Noble, P.E., May 1, 2014). Increasing sight distance would provide more areas with the potential to pass slower traffic, without the need to construct passing lanes. By avoiding construction of passing lanes, the proposed highway footprint would be reduced, minimizing fill in Waters of the U.S. and impacts to other resources.

Historical accident rates on the Haines Highway exceeded the predicted accident rate for most of the project length (DOWL HKM, 2010a). Changing the curve design often requires realignment of substantial lengths of roadway. Because the existing road closely follows the Chilkat River for a substantial portion of the segment, reducing or straightening curves would move the road closer to, or into, the river in some areas. It also moves the road farther from the river in other areas.

To move the road completely away from the river would involve additional acquisition of private property for ROW; acquisition of private property is avoided whenever there are practicable alternatives.

In addition to acquisition of more private property, moving the road completely away from the river would require:

- More fill in wetlands,
- More fill in riverine areas (tributaries to the Chilkat River),
- Adverse impacts to cultural resources, and
- Substantially more rock excavation and corresponding loss of terrestrial habitat.

The design avoids and minimizes potential river impacts where practicable through:

- Selection of a proposed alignment that best balances environmental impacts, including impacts to the Chilkat River, at each location.
- Additions of guardrails at potential Chilkat River fill roadway sections. The addition of guardrails reduces the roadway typical section by 5 feet (Figure 8).
- Along the Chilkat River, the design avoided fill in the river by incorporating passing zones in lieu of passing lanes.
- In consideration of public and agency comments on the Draft EA and Draft EFH Assessment, passing zones throughout the project were reduced to re-introduce highway curvature to avoid and/or minimize impacts to EFH. The result is a proposed reduction in fill in the Chilkat River from 7.7 acres to 3.6 acres and avoidance of all Chilkat River fill or riprap within the Critical Habitat Area of the Alaska Chilkat Bald Eagle Preserve (Preserve) (See Appendix A, Figure Set 1).
- Measures taken to avoid, minimize, and mitigate for river impacts are discussed further in the *Avoidance, Minimization, and Mitigation* section of the document (see page 31).

3.1.4 Chilkat River Bridge Design Considerations

The installation of the new Chilkat River Bridge and removal of the Haines-Fairbanks pipeline crossing would reduce the number of structures in the river from nine pier groups to six, reducing safety hazards associated with debris blockage around the piers.

3.2 Chilkat River and Tributary Conditions

The DOT&PF has completed a Stream and Habitat Inventory (Appendix B) and a Hydrology and Hydraulics Report (Appendix C) for the project study area. Both reports were prepared to describe existing conditions and determine appropriate stream crossing structures.

The EFH affected by this project includes the Chilkat River and 32 tributaries to the river (Table 1). The Chilkat is a glacially fed river that originates in British Columbia and has its terminus in Chilkat Inlet near Haines, Alaska. The river has high turbidity with a large sediment load of glacial silts; during high summer flow suspended sediment concentrations range from 361 to 1,530 milligrams per liter (6,360 to 22,300 tons) per day (Bugliosi, 1988).

A groundwater discharge zone with relatively warm water at the mouth of the Tsuirku River (near Klukwan) keeps a reach of the Chilkat River open in winter.

The ice-free reach provides favorable spawning habitat for late fall and early winter runs of Chum and Coho Salmon (Bugliosi, 1988). The Chilkat River is heavily braided with constantly shifting channels along its last four miles (Betts, 1994), where the floodplain ranges from one to two miles wide.

Between four and seven miles from the river mouth and along the project corridor from approximately Station 80+00 to 500+00, the river bed narrows to approximately one-third of one mile to one mile wide.

Between seven and nine miles from the river mouth, the highway turns away from the main stem of the river, but is adjacent to a side channel from approximately Station 504+00 to 832+00. Along the existing highway alignment, the riverbank is comprised of long sections of vegetated riprap interspersed with shorter sections of mid-maturity forested and herbaceous vegetation (Appendix B).

Table 1 lists the tributary channels within the project area; 27 tributary channels are catalogued by the Alaska Department of Fish and Game (ADF&G) in their Catalog of Waters Important for the Spawning, Rearing or Migration of Anadromous Fishes (Catalog).

In addition to these 27 cataloged tributaries, the ADF&G has identified, and is in the process of adding, five more tributaries in the project area to the Catalog.

3.2.1 EFH Species Present in Project Area

All areas of the Chilkat River adjacent to the highway likely serve as migration and rearing habitat for all five species of Pacific salmon (Chinook, Coho, Sockeye, Chum, and Pink). Gravel side channels of the river also provide spawning habitat for Chum and Coho salmon from September through December. The small-bodied anadromous Eulachon (commonly called Hooligan) spawn within the first eight miles of the river. Other fish species present in the Chilkat River include Steelhead, Cutthroat, Dolly Varden, Whitefish, and Pacific Lamprey. The five salmon species and Eulachon are highly valued resources and are the focus of this assessment.

The tributary channels primarily provide rearing habitat for salmon; some also have gravels suitable for Coho, Pink, and/or Chum spawning. In contrast to the turbid Chilkat River, the tributary channels provide relatively clear water with more abundant sources of food and cover.

Pacific salmon migrate from the marine environment to freshwater streams and rivers of their birth in order to spawn (NOAA, 2012).

Some species spend more time rearing in freshwater than others; Coho spend approximately the first half of their life rearing and feeding in streams such as the Chilkat River tributary channels, and Sockeye spend up to 3 years rearing in freshwater lakes. Chinook typically migrate to sea after the first year of life, and Chum and Pink salmon migrate almost immediately after hatching to estuarine and ocean waters.

Spawning habitat varies by species as well. Coho prefer small streams with stable gravel substrates. Chum spawn in the lowermost reaches of rivers and streams, often near springs. Chinook spawn in sites with larger gravel and more water flow up through the gravel than the

sites used by other Pacific salmon species. Sockeye salmon use the Chilkat River as a migratory corridor to reach spawning and rearing habitat.

Eulachon are a small anadromous fish that typically spend 3 to 5 years in saltwater before returning to freshwater to spawn (NOAA, 2012). Spawning grounds are typically in the lower reaches of larger snowmelt-fed rivers such as the Chilkat River. Spawning occurs over sand or coarse gravel substrates. In Southeast Alaska, the main spawning migration can occur as early as April. The Chilkat has occasional winter runs of Eulachon in January and February, if temperature conditions are right (ADF&G, 2012). Newly hatched young are immediately carried downstream by the river currents to salt water to grow to maturity in the ocean (ADF&G, 2012). A number of Eulachon spawning locations in the Chilkat River adjacent to the Haines Highway were identified in the Stream and Habitat Inventory (Appendix B).

EFH Table 1: Essential Fish Habitat

ID*	Sheet No., Figure Set 1, Appendix A	ADF&G Catalog No.	Name	Species ²
		115-32-10250	Chilkat River	Coho, Pink, Chum, Chinook, Sockeye, Dolly Varden, Cutthroat, Steelhead, Whitefish, Pacific Lamprey, Eulachon
1	2	115-32-10250-2004	Unnamed	Coho, Dolly Varden
2	2	115-32-10250-2006	Schnabel Creek	Coho, Dolly Varden, Cutthroat Trout
3	2	115-32-10250-2006-3003	Unnamed	Coho, Dolly Varden, cutthroat trout
4	2	115-32-10250-2008-3004	Unnamed	Coho, Dolly Varden, Chinook
5	2	115-32-10250-2008	Waterfall Creek	Coho, Dolly Varden, Chinook
6	3	115-32-10250-2010	Unnamed	Coho
7	4	115-32-10250-2014	Unnamed	Coho, Dolly Varden, Chinook, cutthroat
8	5	115-32-10250-2016	Unnamed	Coho, Dolly Varden, Chinook
9	5	115-32-10250-2020	Seven Mile Creek	Coho, Dolly Varden
10	6	Un-cataloged Stream	Unnamed	Coho, Dolly Varden
11	6	115-32-10250-2022	Unnamed	Coho, Dolly Varden, Cutthroat
12	8	115-35-10250-2026	Unnamed	Coho, Dolly Varden, Steelhead, Cutthroat
13	10	115-32-10250-2028	Nine 1/2 Mile Creek	Coho, Dolly Varden
14	10	115-32-10250-2030-3002	Ten Mile Creek	Coho, Dolly Varden, Chum, Pink
15 & 16	11 & 12	115-32-10250-2030	Ten Mile Creek Slough	Coho, Steelhead
17	13	115-32-10250-2032	Eleven 1/2 Mile Creek	Coho, Steelhead
18	14 & 15	115-32-10250-2040	13 Mile Creek	Coho, Cutthroat Trout, Dolly Varden
19	15	115-32-10250-2042	Unnamed	Coho, Chinook, Cutthroat Trout, Dolly Varden, Pink
20	16	115-32-10250-2044	Fourteen Mile	Coho, Dolly Varden, Chinook

²The EFH species are Coho, Chum, Chinook, Sockeye, and Pink Salmon

ID*	Sheet No., Figure Set 1, Appendix A	ADF&G Catalog No.	Name	Species ²
			Creek	
21	18	Un-cataloged Stream	Unnamed	Coho, Chinook, Dolly Varden
22	18	11-32-10250-2050	Unnamed	Coho
23	21	115-32-10250-2060-3012-4001	Moosepaddle Creek	Chinook
24	22	115-32-10250-2050-3011	Horse Farm Creek	Coho, Pink, Dolly Varden
25	25	115-32-10250-2064	Unnamed	Coho
26	28	115-32-10250-2070	21 1/2 Mile Creek	Coho, Dolly Varden, Chinook
27	1	115-32-10250-2002-3017	Unnamed	Coho
28	7	115-32-10250-2024	Lily Pad Creek	Coho, Chum, Dolly Varden
29	4	Un-catalogued Stream	Unnamed	Coho, Dolly Varden
30	17	115-32-1025-2046	Unnamed	Coho, Chinook, Dolly Varden
31	24	Un-catalogued Stream	Unnamed	Coho, Chum, Dolly Varden
32	24	Un-catalogued Stream	Unnamed	Unknown

*Streams are identified by ID number on the figure set located in Appendix A.

4.0 PROJECT EFFECTS ON ESSENTIAL FISH HABITAT

4.1 Construction (Short-Term) Effects

Temporary adverse effects to EFH could occur during placement of fill in the Chilkat River for the road realignment and bridge installation, and during culvert replacements and tributary channel enhancement work. Temporary increases in sediment loads and turbidity in streams would occur during construction, but this would be avoided and/or minimized under an Erosion and Sediment Control Plan using Best Management Practices (BMPs) to reduce erosion and sedimentation during construction.

4.2 Operational (Long-Term) Effects

The primary functions of the Chilkat River and its tributaries can be divided into five categories that include: stream evolution through morphologic processes, maintenance of hydrologic balance, continuity of sediment processes, provision of habitat, and maintenance of chemical processes and pathways.

The proposed project would impact EFH. The goal is to avoid adverse impacts to the extent practicable. If adverse impacts cannot be avoided the goal is to minimize impacts to the extent practicable. If adverse impacts exist after avoidance and minimization, the goal is to at least offset adverse impacts by providing beneficial impacts (compensatory mitigation) primarily in the form of stream restoration and enhancement.

EFH (freshwater habitat) identified in the Fishery Management Plan “Alaska Stocks of Pacific Salmon” pertinent to project impacts is the general distribution area for freshwater eggs, larvae, and juveniles identified in the ADF&G’s Catalog of Waters Important for the Spawning, Rearing, or Migration of Anadromous Fishes (Catalog) *and* contiguous rearing areas within the boundaries of ordinary high water. For purposes of this assessment, EFH also includes identified fish-bearing streams not currently listed in the Catalog. Adjacent wetlands are included, for information purposes, because of the important function provided to EFH.

The areas where fill is proposed to be placed in the main stem of the Chilkat River or in its side channels or backwaters are depicted on Figure Set 1, in Appendix A.

4.2.1 Impacts to EFH Wetlands and Mitigation

Fill would be placed in approximately 22.2 acres of wetlands (see Table 2). The highest value of the project wetlands is to provide water to salmonid habitat³. Fill in fish bearing wetlands would affect rearing and present Coho, Chum, and Pink Salmon. To mitigate for unavoidable impacts, streams would be created/enhanced to provide Coho Chum, Pink and Chinook spawning and rearing areas, and a Pink resting area.

To mitigate for unavoidable impacts to wetlands

1. 5,071 LF of fish bearing streams would be created/enhanced (see Table 2a and Appendix D).

³ DOWL/HKM, *Wetlands and Stream Functions and Values Assessment, Haines Highway MP 3.5 to 25.3*, Available at http://dot.alaska.gov/sereg/projects/haines_hwy/documents.shtml

2. 1,991 LF of culverts in fish bearing streams would be upgraded to fish passage standards. The project would reconnect or improve habitats that have been fragmented by deficient culverts, resulting directly and/or indirectly in an increase in the quality and quantity of fish habitat and fish productivity.⁴
3. Additionally, an off-site fish passage improvement project on Mud Bay Road would be completed.
4. About ¼ acre of EFH wetlands would be created near MP 17.
5. Overwintering salmon habitat would be enhanced in a small section of the Chilkat River near MP 16.

Further details are in the following EFH Tables 2 and 2a. Impact and mitigation areas are shown in EFH Figure 1.

EFH Table 2: EFH Wetland Impacts for Entire Project (Acres)

Type	Value	EFH Species ⁵ & Life Stage ⁶	Total Proposed Fill in July 2013 EA	Total Proposed Fill for Revised Proposed Action	Additional Avoidance Achieved (Difference)
Emergent-Permanently Flooded (PEM1H)	High	CO _r ,CH _p ,P _p	9.1	8.4	0.7
Emergent-Saturated (PEM1B)	High	CO _r	3.4	3.1	0.3
Scrub Shrub-Saturated (PSS1B)	Medium	CO _r	<.1	0.01	0.0
Scrub Shrub-Seasonally Flooded (PSS1E)	Medium	CO _r	1.7	1.7	0.0
Scrub Shrub-Permanently Flooded (PSS1H)	Medium	CO _r ,CH _p ,P _p	8.0	7.7	0.3
Total			23.6	22.2	1.4

⁴ U.S. Fish and Wildlife Service. Alaska Fish Passage Program Fact Sheets

⁵ Salmon, Chinook (K), Sockeye (S), Coho (CO), Chum (CH), Pink (P)

⁶ Spawning (s), rearing (r), presence (p)

EFH Table 2a: Mitigation for EFH Wetland Impacts - EFH Stream Creation/Enhancements

Mitigation Site App. Station (see EFH Fig. Set 1)	How is tributary improved? ⁷	Benefits	Tributary length improved/ created (LF)	Available for mitigation credit?
240+38	Stream moved away from toe of slope; Woody debris added; no more annual brushing on one side.	Enhanced coho salmon, cutthroat trout, and Dolly Varden char rearing	195	Yes
512+24	Stream moved away from toe of slope; Woody debris added; improved riparian vegetation	Enhanced coho salmon, steelhead trout, and Dolly Varden char rearing. Additional pink and chum salmon habitat.	1000	Yes
530+70	Stream moved away from toe of slope; Woody debris added; improved riparian vegetation	Enhanced coho salmon rearing	126	Yes
608+00	Increased stream length of un-cataloged stream, and increased flow to 11.5 Mile Creek.	Enhanced coho salmon rearing, and cutthroat trout spawning and rearing.	980	Yes
647+00 & 653+00	Provide new stream channel away from the toe of slope.	Enhanced coho salmon rearing and spawning, Chinook salmon rearing, Pink salmon spawning, and cutthroat trout spawning and rearing.	500	Yes
736+83	Provide overwintering habitat in the Chilkat River and rearing channel upstream.	Enhanced coho salmon and Dolly Varden char rearing. Chum and coho salmon spawning in Chilkat River.	890	Yes
869+00	Provide improved rearing and outmigration from NSRAA incubation boxes, woody debris added and improved riparian vegetation. Create about .25 ac. of scrub-shrub wetlands.	Enhanced coho salmon rearing and pink salmon resting.	500	Yes
895+00	Woody debris added, improve hydrology, and expand surrounding wetlands at Horse Farm Creek	Enhanced coho salmon rearing, and pink salmon spawning.	800	Yes

⁷ See Appendix E for details

Mitigation Site App. Station (see EFH Fig. Set 1)	How is tributary improved? ⁷	Benefits	Tributary length improved/ created (LF)	Available for mitigation credit?
MP 7.1 Mud Bay Road Culvert	Provide access to low gradient upstream rearing habitat.	Enhanced coho salmon, steelhead trout, Dolly Varden char and cutthroat trout rearing.	80	Yes
Culverts for fish passage in anadromous waters	Tributary is brought up to fish passage standards per the MOA between DOT&PF and ADF&G (DOT&PF, ADF&G, 2001)	Proposed culverts will remove any restrictions to fish passage.	1,991 (see table 2b) ⁸	Yes
Totals			7,062 LF	

EFH Table 2b: Mitigation for EFH Wetland Impacts – Proposed Fish Passage Culvert Improvements

EFH Fig. Set 1 Sheet	Station	ADFG Catalog	Fish Species	Existing Conditions	Proposed Culvert Replacement (Tier 1 or Tier 2)	Improved Stream Length
2	222+87	115-32-10250-2004	Coho, Dolly Varden	48" CMP	Tier 1; 95"x67" Aluminum Pipe Arch	102
2	229+23	115-32-10250-2006	Coho, Dolly Varden, Cutthroat trout	24" CMP	Tier 1; 60" CMP	94
2	232+22 to 231+69	115-32-10250-2006	Coho, Dolly Varden, Cutthroat trout	24" CMP	Tier 1; 60" CMP	60
2	240+41	115-32-10250-2006-3003	Coho, Dolly Varden, Cutthroat trout	24" CMP	Tier 1; 60" CMP	76
2	244+91 to 244+60	115-32-10250-2006	Coho, Dolly Varden, Cutthroat trout	24" CMP	Tier 1; 60" CMP	40
2	245+38	115-32-10250-2008-3004	Coho, Dolly Varden, Chinook, Cutthroat trout	36" CMP	Tier 1; 60" CMP	76

⁸ Refer to EFH Fig. set 1. Upgraded culverts are at approximately Stations 246, 249, 294, 316, 320, 326, 367, 370, 383, 421, 514, 532, 591, 659, 712, 769, 859, 890, 964, 975

EFH Fig. Set 1 Sheet	Station	ADFG Catalog	Fish Species	Existing Conditions	Proposed Culvert Replacement (Tier 1 or Tier 2)	Improved Stream Length
2	248+43	115-32-10250-2006	Coho, Dolly Varden, Cutthroat trout	24" CMP	Tier 1; 60" CMP	70
4	292+92	115-32-10250-2014	Coho, Chinook, Dolly Varden, Cutthroat trout	Two 24" CMPs	Tier 1; 75"x55" Aluminium Pipe Arch	66
5	319+22	115-32-10250-2016	Coho, Chinook, Dolly Varden	36" CMP	Tier 1; 81"x59" Aluminium Pipe Arch	72
5	324+84	115-32-10250-2020	Coho, Dolly Varden	48" CMP	Tier 1; 95"x67" Aluminium Pipe Arch	80
6	366+48	115-32-10250-2022	Coho, Dolly Varden, Cutthroat trout	24" CMP	Tier 1; 48" CMP	70
7	382+11	115-32-10250-2024	Coho, Dolly Varden	36" CMP	Tier 1; 48" CMP	76
10	483+70	115-32-10250-2028	Coho, Dolly Varden	48" CMP	Tier 1; 95"x67" Aluminum Pipe Arch	94
10	512+34	115-32-10250-2030-3002	Coho, Pink, Chum, Dolly Varden	36" & 24" CMPs	Tier 1; 151"x89" Aluminum Pipe Arch	78
11	530+70	115-32-10250-2030	Coho, Steelhead	24" CMP	Tier 1; 60" CMP	78
13	589+29	115-32-10250-2032	Coho, Dolly Varden, Cutthroat trout	Two 24" CMP	Tier 1; 72" CMP	74
14	648+90	115-32-10250-2040	Coho, Chinook, Pink, Dolly Varden, Cutthroat trout	36" CMP	Tier 1; 8'-10" by 6'-1" arch pipe	60
15	654+20	115-32-10250-2040	Coho, Chinook, Pink, Dolly Varden, Cutthroat trout	36" CMP	Tier 1; 8'-10" by 6'-1" arch pipe	60
15	656+80	115-32-10250-2042	Coho	New Crossing	Tier 1 or Tier 2; design to be completed	60
16	711+75	115-32-10250-2044	Coho, Chinook, Dolly Varden	Two 36" CMP	Tier 1; 12'-7" by 8'-4" arch pipe	120

EFH Fig. Set 1 Sheet	Station	ADFG Catalog	Fish Species	Existing Conditions	Proposed Culvert Replacement (Tier 1 or Tier 2)	Improved Stream Length
17	738+25	115-32-10250-2046	Coho, Chinook, Dolly Varden	24" CMP	Tier 1; 7'-3" by 5'-3" arch pipe	70
18	768+75	Un-cataloged Stream	Coho, Chinook, Dolly Varden	36" CMP	Tier 1; 3.5' diameter CMP	60
18	772+10	11-32-10250-2050	Coho, Chinook, Dolly Varden	24" CMP	Tier 1 or Tier 2; design to be completed	66
21	871+10	115-32-10250-2060-3012-4001	Coho, Chinook, Chum, Dolly Varden	6'-1" by 4'-7" arch pipe	Tier 1; 11'-7" by 7'-5" arch pipe	160
22	887+60	115-32-10250-3011	Coho, Pink, Dolly Varden	Two 36" CMP	Tier 1; 9'-4" by 6'-3" arch pipe	129
Total						1,991 LF

4.2.2 Impacts to the Chilkat River and Mitigation

Approximately 3.6 acres of riverine habitat would be impacted due to the placement of 12,512 linear feet (2.36 miles, EFH Table 3) of fill material into the Chilkat River. All five EFH salmon species, Chinook, Chum, Coho, Pink, and Sockeye would be affected. To mitigate for impacts to salmon, DOT&PF consulted with ADF&G to develop mitigation areas that mimic existing successful habitat in the Chilkat River watershed.

ADF&G has shared data on Coho and King salmon distribution within the lower Chilkat River (See Appendix G). Discussions with the ADF&G concerning the fish distribution in the lower Chilkat River indicated:

- Woody debris in the Chilkat River provides fish habitat.
- The most salmonids caught in minnow traps came from areas of natural vegetated stream banks with trees overhanging the banks (personal communication with Richard Chapell, ADF&G Sport Fish Division, April 4, 2014).
- Also, large rocks with woody debris provide fish habitat diversity (personal communication with Kate Kanouse, ADF&G Habitat Division, April 25, 2014).

Through further consultation with the NMFS, the United States Fish and Wildlife Service (USFWS), and the ADF&G in March and April 2014, coupled with salmon distribution data, proposed locations and conceptual designs have been developed for fish habitat enhancement within the Chilkat River (locations in EFH Table 3a and details shown in Figures 9 and 10).

EFH Table 3: Impacts to the Chilkat River

Type	Value	Total Proposed in July 2013 EA	Total Proposed Fill for Revised Proposed Action	Additional Avoidance Achieved (Difference)
Riverine - Chilkat River, Upper Perennial Open Water (R30W) for Entire Project	High	7.7 acres	3.6 acres	4.2 acres
		15,550 LF	12,512 LF	3,038 LF
Total		7.7 acres	3.6 acres	4.2 acres
Riverine - Chilkat River, Upper Perennial Open Water (R30W) Linear Feet (LF) of fill on top of Previously Riprapped Slopes		10,258 LF	7,490 LF	2,768 LF
Riverine - Chilkat River, Upper Perennial Open Water (R30W) Linear Feet of fill on top of Original Banks		5,292 LF	5,022 LF	270 LF

EFH Table 3a: In-River Mitigation for Impacts to the Chilkat River

Detail	Qty	Approx. Station From	Approx. Station To	Comment
Woody debris ⁽¹⁾ adjacent to and upstream of large rocks ⁽²⁾	2	284+00	289+00	2 within this range
Woody debris ⁽¹⁾ adjacent to and upstream of large rocks ⁽²⁾	2	298+00	302+00	2 within this range
Woody debris ⁽¹⁾ adjacent to and upstream of large rocks ⁽²⁾	1	313+00		
Woody debris ⁽¹⁾ adjacent to and upstream of large rocks ⁽²⁾	1	337+00		
Woody debris ⁽¹⁾ adjacent to and upstream of large rocks ⁽²⁾	2	350+00	357+50	2 within this range
Woody debris ⁽¹⁾ adjacent to and upstream of large rocks ⁽²⁾	1	374+00		
Fish Wheel Site ⁽³⁾	1	392+00	--	Fish wheel site rehab/or new
Woody debris ⁽¹⁾ adjacent to and upstream of large rocks ⁽²⁾	1	398+00		
Vegetated river protrusion	1	399+00	401+00	Vegetated river protrusion within this range
Fish Wheel Site ⁽³⁾	1	401+50	405+00	Fish wheel site rehab/or new
Woody debris ⁽¹⁾ adjacent to and upstream of large rocks ⁽²⁾	1	408+00		
Fish Wheel Segment ⁽³⁾	1	410+50	416+00	Fish wheel site rehab/or new
Woody debris ⁽¹⁾ adjacent to and upstream of large rocks ⁽²⁾	1	423+75		
Woody debris ⁽¹⁾ adjacent to and upstream of large rocks ⁽²⁾	1	425+50		
Vegetated river protrusion	1	436+50	439+50	Vegetated river protrusion within this range
Woody debris ⁽¹⁾ adjacent to and upstream of large rocks ⁽²⁾	1	441+00		
Woody debris ⁽¹⁾ adjacent to and upstream of large rocks ⁽²⁾	1	444+00		
Fish Wheel Segment ⁽³⁾	1	448+50	464+00	Fish wheel site rehab/or new
Woody debris ⁽¹⁾ adjacent to and upstream of large rocks ⁽²⁾	1	456+00		
Fish Wheel Site ⁽³⁾	1	458+00	--	Fish wheel site rehab/or new

Detail	Qty	Approx. Station From	Approx. Station To	Comment
Woody debris (1) adjacent to and upstream of large rocks (2)	1	494+00		
Fish Wheel Segment (3)	1	498+00	500+00	Fish wheel site rehab/or new
Woody debris (1) adjacent to and upstream of large rocks (2)	1	586+50		
Woody debris (1) adjacent to and upstream of large rocks (2)	1	612+00		
Woody debris (1) adjacent to and upstream of large rocks (2)	1	613+00		
Woody debris (1) adjacent to and upstream of large rocks (2)	1	618+00		
Woody debris (1) adjacent to and upstream of large rocks (2)	2	668+00	672+00	
Woody debris (1) adjacent to and upstream of large rocks (2)	2	689+00	693+00	
Woody debris (1) adjacent to and upstream of large rocks (2)	1	698+00		
Woody debris (1) adjacent to and upstream of large rocks (2)	2	700+00	703+00	
Woody debris (1) adjacent to and upstream of large rocks (2)	1	753+00		
Woody debris (1) adjacent to and upstream of large rocks (2)	1	761+00		
Woody debris only	1	816+00	819+00	No rock placement - may adversely affect hydrology
Woody debris (1) adjacent to and upstream of large rocks (2)	1	820+00		
Woody debris only	1	873+00		No rock placement - may adversely affect hydrology. Use Cottonwoods with root wads.
Woody debris (1) adjacent to and upstream of large rocks (2)	2	1039+00	1044+00	2 within this range - May be a good spot for horizontal logs for eagle perches
Woody debris (1) adjacent to and upstream of large rocks (2)	1	1055+00		May be a good spot for horizontal logs for eagle perches

Notes:

1. Woody Debris shall consist of an even mixture of root wads, stems, and logs:
 - a. Root wads shall consist of stems with root balls attached. Stem diameter shall be at least 16 inches. Stem length shall range from 10 to 15 feet. All twigs and branches, excluding roots, shall be removed to stubs no longer than four (4) inches.
 - b. Stems shall consist of branches and shoots ranging in size from 1/2 inch to 2 inches and 4 to 6 feet in length.
 - c. Logs shall be at least 4 inches in diameter and 4 to 8 feet in length. Logs with root wads attached are preferred.
2. Boulders shall consist of: Class III and Class IV riprap materials. Nominal rock sizes are provided in the tables below. Larger sizes are allowed.

Table 3b: Class III Riprap

Class III	Nominal Rock Size (inches)	Gradation (% smaller)	Rock Weight (pounds)
	27	90-100	1,400
	22	0-50	700
	7	0-15	25

Table 3c: Class IV Riprap

Class IV	Nominal Rock Size (inches)	Gradation (% smaller)	Rock Weight (pounds)
	43	90-100	5,400
	31	0-50	2,000
	18	0-15	400

3. Fish Wheel Segments/Sites: A total of six (6) sites are indicated, identified as either a specific location, or generally, for a reach of stream.

The first conceptual design, noted as “Woody debris adjacent to and upstream of large rocks” in EFH Table 5, shows large boulders at the toe of the embankment armoring in such a way to retain woody debris just upstream of the boulders (Figure 9). The intent is to offer habitat diversity for migrating salmonids. The second conceptual design (Figure 10) creates vegetated river protrusions into the Chilkat River to provide fish habitat similar to the most productive natural stream banks shown in the salmon distribution data.

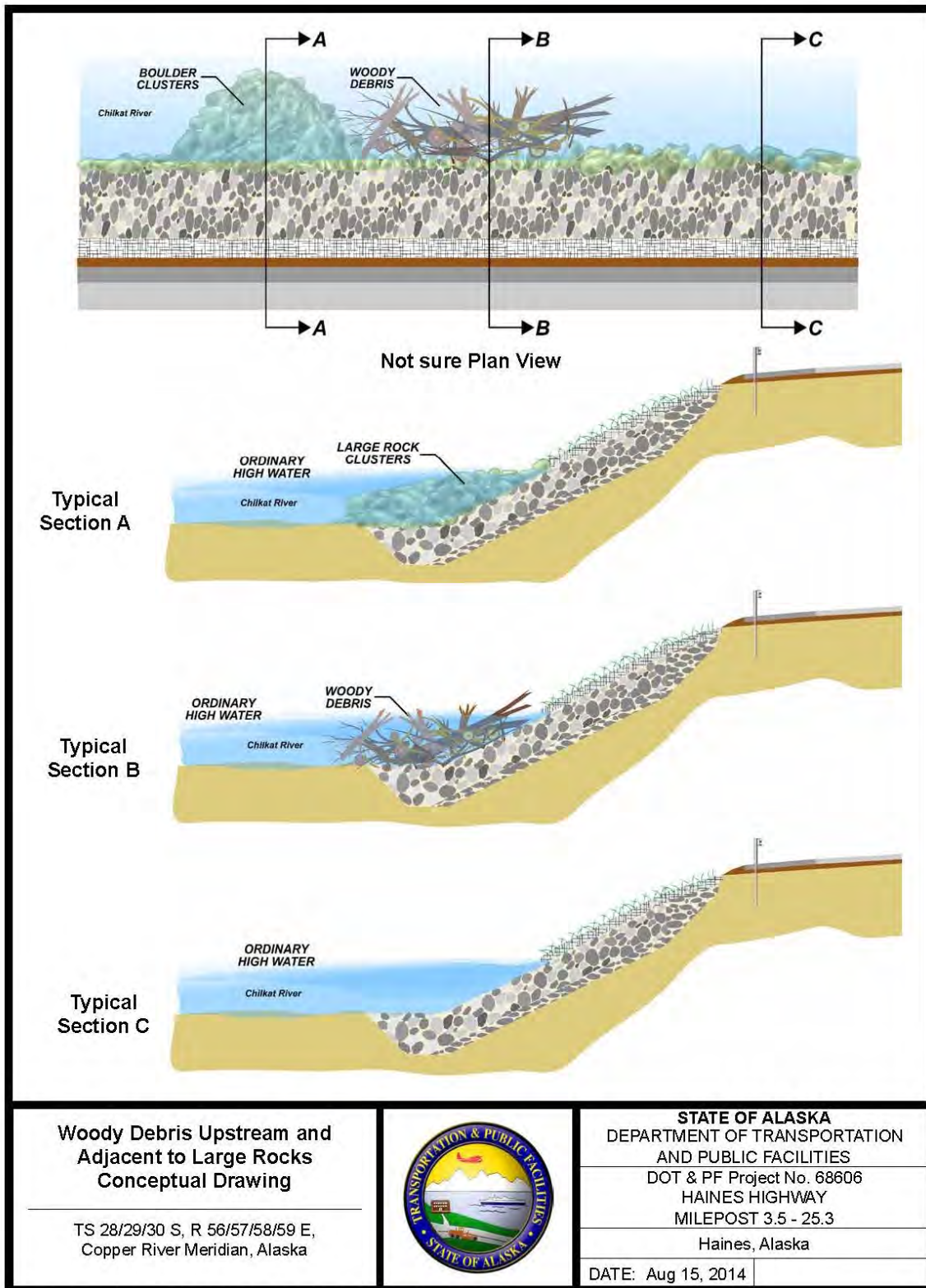

**Figure 8: Woody Debris Upstream and Adjacent to Large Rocks
 (Not to Scale)**

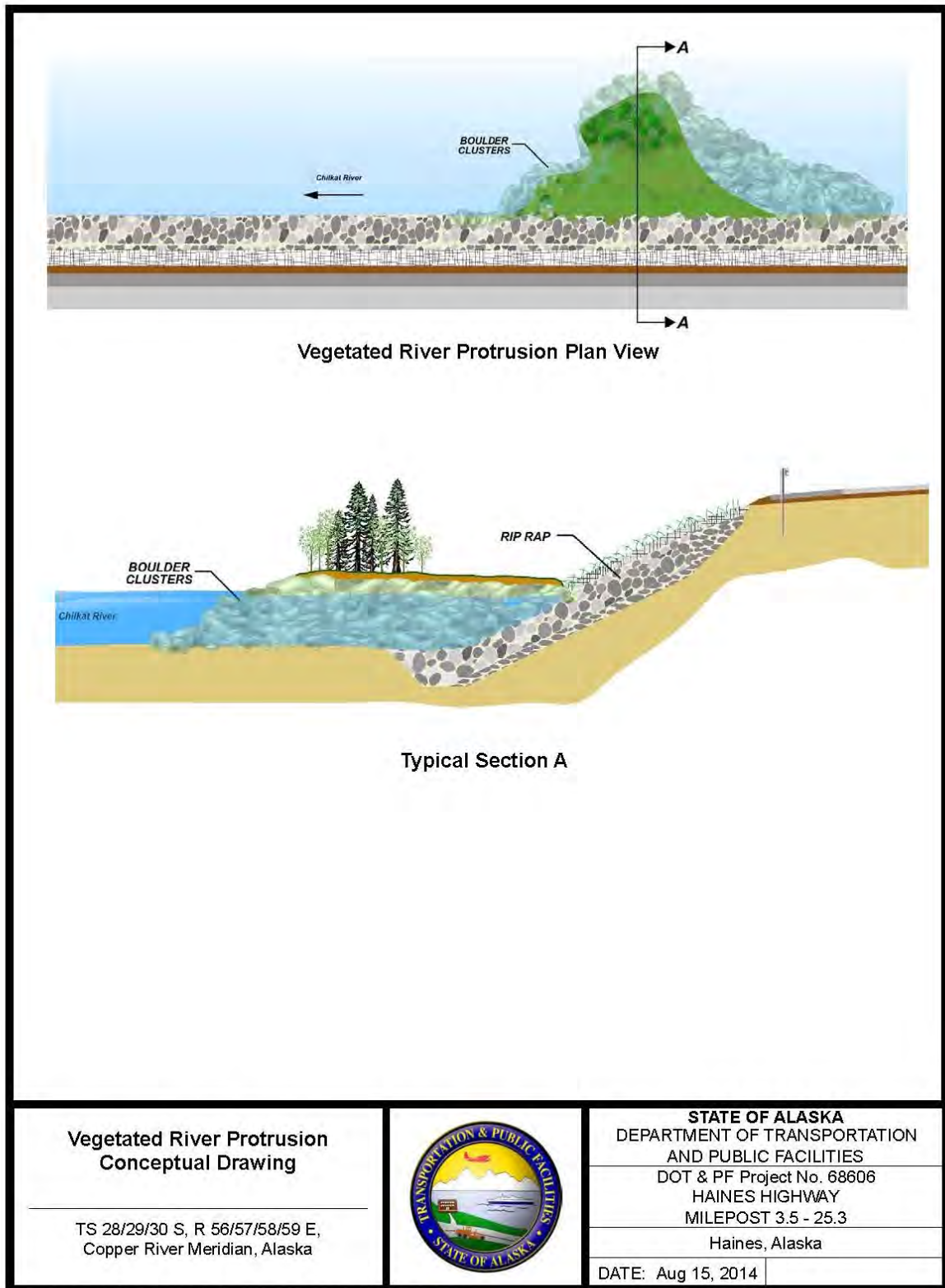

**Figure 9: Vegetated River Protrusion
 (Not to Scale)**

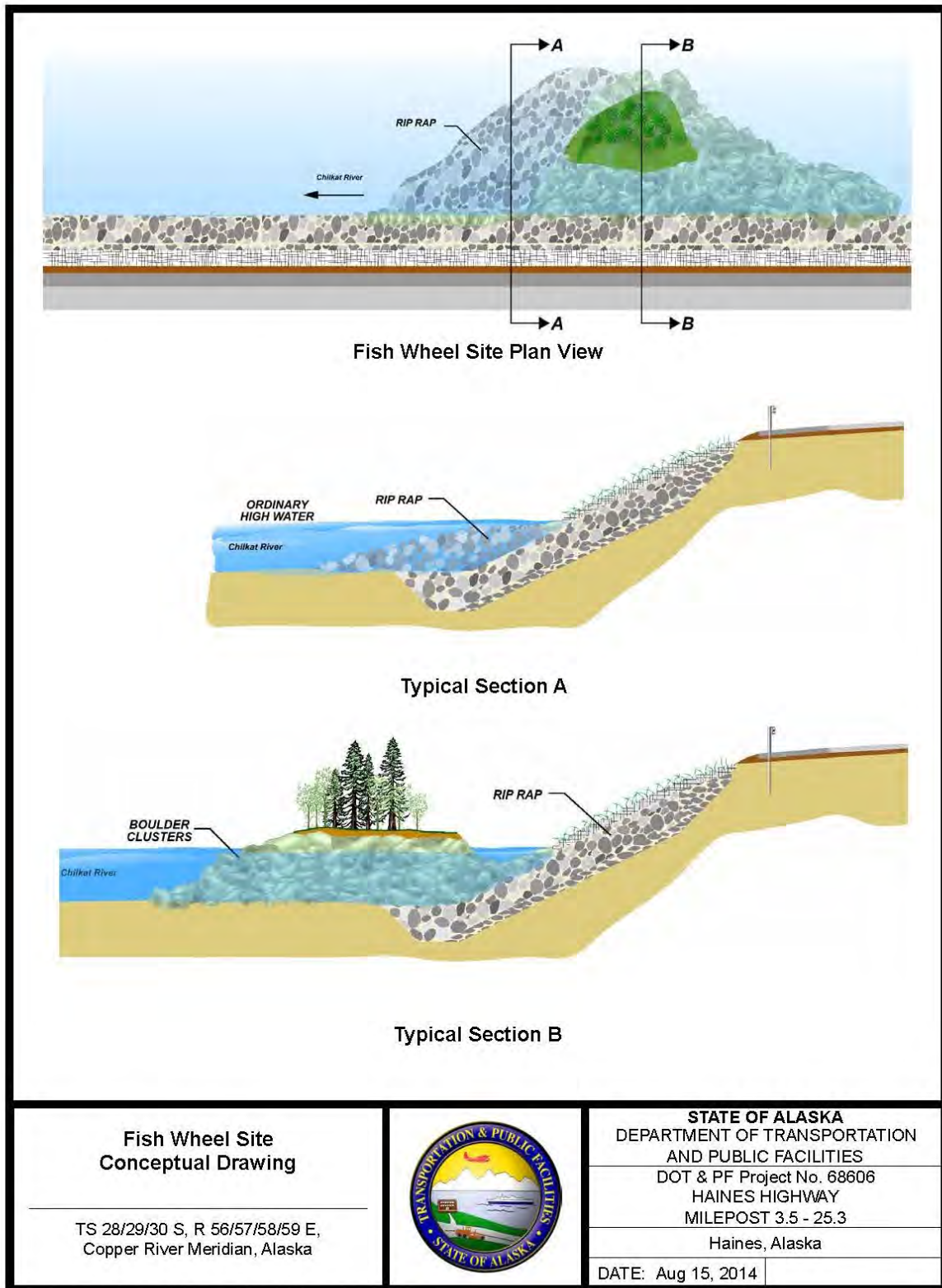

**Figure 10: Fish Wheel Site
 (Not to Scale)**

The Haines Highway road improvements project would positively address ADF&G commercial fishery monitoring concerns associated with fish wheel operation on the Chilkat River.

The installation of structures described below would improve local hydraulic conditions that favor sustained fish wheel operation.

The third conceptual design (Figure 11) incorporates,

1. hydrologic conditions to replicate scour holes in the Chilkat River with
2. vegetated river protrusions.

Precise locations and details of each of these sites will be determined during final design of each construction segment.

Although highway embankment armoring often results in loss of some riparian vegetation (a nutrient source), much of the riverbank along the highway consists of riprap that has re-vegetated naturally since its placement (Appendix A, Figure Set 1 and Appendix B). The re-vegetation process would be encouraged by seeding, planting live cuttings, and/or containerized plants along the middle and upper banks as illustrated in Figure 8. Realignment and enhancement of some tributaries away from the roadway would also increase riparian vegetation and nutrient input (U.S. Army Corps of Engineers [USACE], 2003).

Approximately 12,512 LF of riprap armoring (3.6 acres) would be placed in the Chilkat River. Of this, 7,490 LF would be vegetated riprap replacing previously vegetated riprap and 5,022 LF would be placed on river bank that may not have been previously armored with riprap.

A summary of mitigation efforts (Table 3a) to offset unavoidable impacts to the Chilkat River is,

- 36 sites with woody debris adjacent to and upstream of large rocks would be created in the Chilkat River,
- 2 vegetated river protrusions into the Chilkat River would be created,
- 6 fish wheel sites with vegetated river protrusions would be created.

4.2.3 Direct Impacts to Chilkat River Tributaries and Mitigation

Direct impacts to tributaries of the Chilkat River due to road widening and/or realignment are 2,748 linear feet (see EFH table 4). Impacts to tributaries under the revised proposed alignment are slightly higher (+ 313 linear feet), due to the alignment shifts to avoid and/or minimize impacts to high-value wetlands and original Chilkat River stream banks. As mitigation all direct stream impacts would be replaced, in-kind or better.

EFH Table 4: Direct Impacts in Chilkat River Tributaries (Lineal Feet)

Approximate Location & Type	Value	Total Proposed in July 2013 EA	Total Proposed Impact for Revised Proposed Action (LF)	Additional Avoidance Achieved (Difference)
192+00 Stream Impacts	High		298.45	
223+00 Stream Impacts	High		110.14	
231+00 Stream Impacts	High		165.60	
233+00 Stream Impacts	High		24.83	
240+00 Stream Impacts	High		295.08	
259+00 Stream Impacts	High		244.94	
351+00 Stream Impacts	High		257.91	
485+00 Stream Impacts	High		31.39	
570+00 Stream Impacts	High		23.30	
643+00 Stream Impacts	High		34.86	
735+00 Stream Impacts	High		454.33	
772+00 Stream Impacts	High		588.59	
1000+00 Stream Impacts	High		94.38	
1103+00 Stream Impacts	High		125.04	
Tributaries to Chilkat River – Stream Impacts (Direct Fill)	High	2,435 LF	2,748 LF (.65 acres)	(313) LF

EFH Table 4a: Mitigation for Direct Impacts to Chilkat River Tributaries (Lineal Feet)

Description	Value	Total Direct Impacts	Total Direct Mitigation (Stream Replacement in-kind)
Tributaries to Chilkat River – Stream Impacts (Direct Fill)	High	2,748 LF (.65 acres)	At least 2,748 LF

4.3 Avoidance and Minimization Measures

4.3.1 Avoidance

- Along the Chilkat River, the design avoided fill in the river by incorporating passing zones rather than expanding the highway to accommodate passing lanes.
- At the Chilkat River Bridge, the design avoided a relatively long in-water construction period by selecting driven piles rather than placement of concrete bridge foundations.
- At the Chilkat River Bridge, DOT&PF has minimized impacts to EFH by placing abutments for the new Chilkat River Bridge above ordinary high water.
- The addition of guardrail reduced the number of areas affected in the Chilkat River. (See avoidance column in Table A-1 in Appendix A for specific locations.)
- Two existing highway turnouts that provide access to wetland and riverine habitat would be permanently closed to prevent further damage to EFH caused by operation of off-road motor vehicles and unregulated dumping.
- In consideration of public and agency comments on the July 2013 EA and Draft EFH Assessment, passing zones throughout the project extent were reduced from 70 percent to 60 percent in order to re-introduce highway curvature and further reduce fill in EFH.
- The avoidance measures listed above resulted in a ***30,341 square foot (2,042 linear foot) reduction of fill in the Chilkat River.*** (See Table A-1 in Appendix A for details.)

4.3.2 Minimization

- The Chilkat River fill footprint was minimized by making the slope of the road embankment as steep as possible (2:1).
- Along the Chilkat River, the proposed design has minimized impacts to EFH by adding guardrails and reducing the road footprint to minimize the fill need in the river and its tributaries. (See avoidance column in Table A-1 in Appendix A for specific locations.)
 - Guardrails allow the road to be designed with narrower shoulders and with steeper slopes on the embankment. Additionally, the guardrail typical section was reduced from 4 feet to 2 feet to further minimize fill in the Chilkat River.
 - The minimization measures listed above ***reduced the impacts to the Chilkat River by 217,804 square feet (3,286 linear feet).*** (See Table A-1 in Appendix A for details.)
- To minimize impacts from construction activities,
 - BMPs identified in the Erosion and Sediment Control Plan would be used during construction to minimize the introduction of suspended sediment to the Chilkat River and its tributaries. Specific BMPs may include, but are not

limited to, the use of silt fences, straw wattles, inlet and outlet protectors, check dams, and diversionary dams.

- The Contractor would be required to prepare a Stormwater Pollution Prevention Plan (SWPPP) in accordance with DEC's Alaska Pollutant Discharge Elimination System (APDES) General Permit for Construction Activities in Alaska. The Contractor would also be required to develop a Hazardous Materials Control Plan (HMCP) to address hazardous material that would be used during project construction and to detail measures to control discharges of such material into Waters of the U.S.
- No excess material would be disposed of in any waterway.
- Stream flow would not be impaired during timing windows stipulated by ADF&G.
- Areas to be cleared would be limited to the minimum extent necessary. All disturbed areas would be permanently re-vegetated.
- The following permits would be obtained prior to construction, and all permit stipulations would be adhered to:
 - o ADF&G Title 16 Fish Habitat Permit
 - o USACE Section 404/10 Permit

 - o DEC 401 Water Quality Certification
 - o U.S. Coast Guard (USCG) Section 9 Bridge Permit
 - o U.S. Fish and Wildlife Service (USFWS) Bald Eagle Disturbance Permit
- DOT&PF would adhere to ADF&G permitted in-water work windows to avoid impacts to spawning, rearing, or migrating fish. Times when Chilkat River in-water work may be avoided at specific locations are proposed in Table 5.

EFH Table 5: Chilkat River In-Water Work by Location

EFH of Concern	Location (Stream Habitat Inventory, Apx B)	In-Water Work Avoidance
Eulachon spawning habitat; eulachon spawn in Chilkat River starting in early April. Emergence and migration to ocean within about 40 days.	In-water work locations downstream of Station 390+00: Station 263+10 to 263+60 Station 297+00 to 300+80 Station 350+00 to 356+00 Station 364+00 to 367+60 Station 370+15 to 375+20 Station 378+80 to 390+00	Avoid fill in river in listed areas between Stations 0+00 and 390+00 during April and May.
Salmon spawning habitat; Chum and Coho spawn between September and December. Emergence and migration to rearing areas occurs May to July.	Station 733+00 to 736+80	Avoid fill in river between Stations 733+00 and 736+80 from September to July.

*Timing restrictions on work in tributaries would be negotiated with the ADF&G agencies for each specific area during the permitting phase.

- At the Chilkat River Bridge, DOT&PF has minimized impacts to EFH by reducing the total number of in-water structures. By using girder lengths more than twice the length of the existing bridge’s girders, six fewer in-water pier groups would be required (Figure 11).

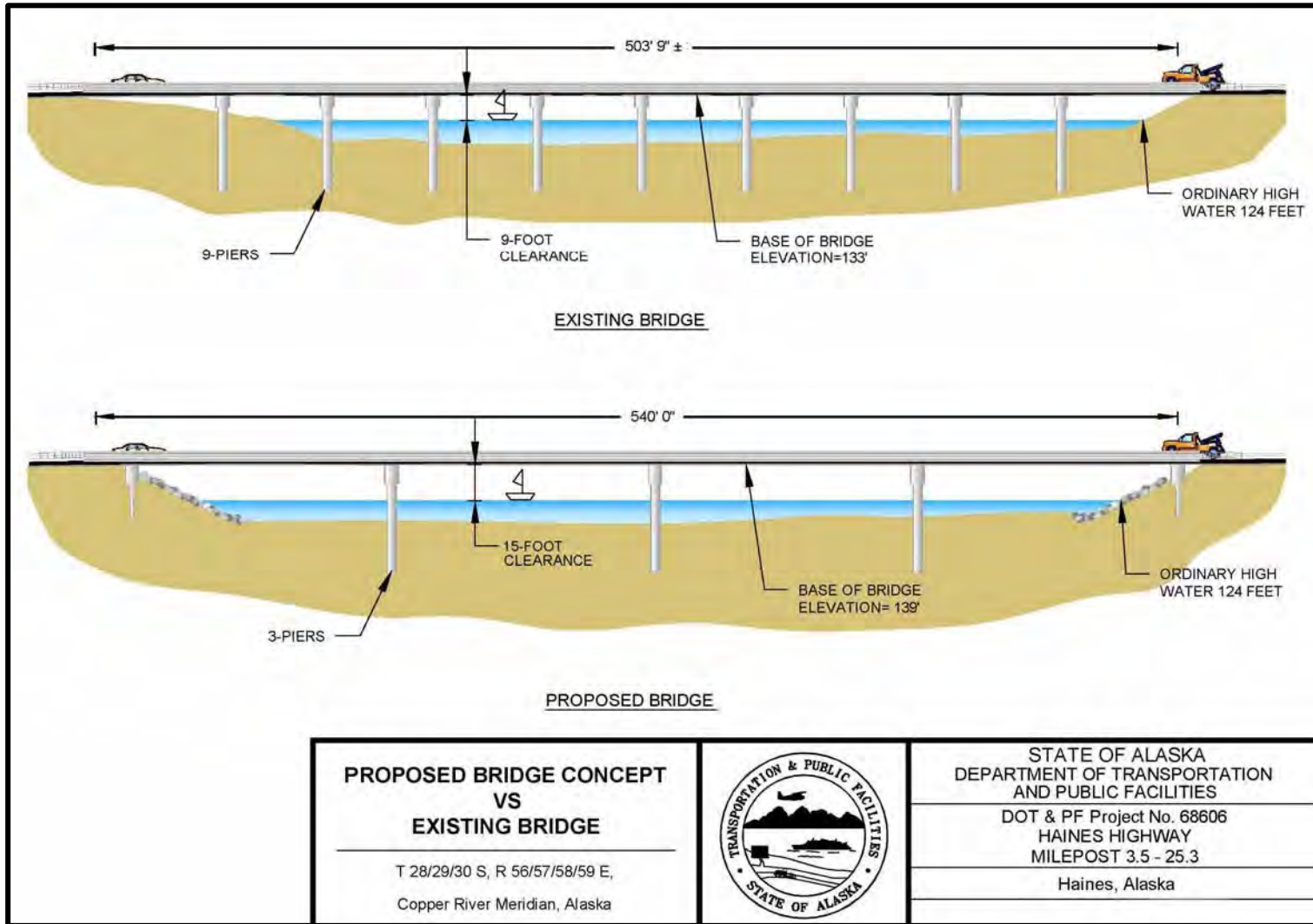

Figure 11: Proposed Bridge Concept versus Existing Bridge
 (Not to Scale)

5.0 PROPOSED CONSERVATION MEASURES

In addition to the avoidance and minimization measures listed above, DOT&PF would also implement the following conservation measures:

- As mitigation for the loss of 22.2 acres of wetlands, the DOT&PF proposes to create and/or enhance approximately 5,071 linear feet of fish stream habitat and improve fish passage by installing 1,991 LF of fish passage culverts (DOT&PF/ADF&G, 2001), as summarized in EFH Table 2a, described in Appendix E, and shown in Appendix A, Figure Set 1. Stream enhancements would improve existing habitat and return degraded habitats to their natural condition. Proposed stream enhancements are summarized in Table 2a (refer to Appendix E for complete details). Mitigation also includes upgrading an existing perched culvert, outside the project area, to fish passage standards (see MP 7.1 culvert details in Appendix D)
- As mitigation for 3.6 acres of impacts to the Chilkat River,
 - woody debris would be introduced in 36 in-water areas,
 - 8 river vegetated protrusions would be constructed,
 - an identified abandoned car over hanging Cannery Creek, near the Mud Bay road would be removed, and
 - Loose styrofoam and other plastic debris would be removed at the outlet of Cannery Creek,
- The 2,748 linear feet of impacts to tributary channels from road widening and/or realignment would be replaced in-kind or better. The design of these tributary realignments will be completed as part of the permitting process.
- As mitigation for unanticipated impacts to waters of the US, DOT&PF will provide funds to a USACE approved in-lieu fee preservation agent, Seal Trust, to preserve portions of the fish bearing stream, Horse Farm Creek⁹ near Milepost 18 or preservation of a similar or better property within the Chilkat River Valley.

⁹ On the ADF&G Anadromous Waters Catalog as stream 115-32-10250-206

6.0 AGENCY CONSULTATION

The DOT&PF and the FHWA initiated consultation with multiple agencies, including the NMFS, in 2005. The DOT&PF sent a formal letter to the NMFS on November 25, 2005, requesting scoping comments on the proposed project and notifying them of an agency scoping meeting scheduled for December 5, 2005. A representative from NMFS attended the December 5, 2005 scoping meeting and provided comments to the DOT&PF. Given the issues identified during agency scoping, the project team determined that an Agency Interdisciplinary Team (IDT) should be formed to facilitate an open and cooperative process between federal, state, and local resource agencies. The IDT included representatives from NMFS, USFWS, the USACE, Environmental Protection Agency, ADF&G, Alaska Department of Natural Resources, and the Takshanuk Watershed Council. The IDT members initially met twice with the DOT&PF in Juneau in April and July 2006.

Following the 2006 field season, the project was delayed for approximately two years due to funding issues.

Upon resumption of the project, DOT&PF notified NMFS and the other IDT participants by letter and e-mail invitations on January 28, February 27, and March 2, 2009, of a third IDT meeting March 3, 2009. A representative from NMFS attended the March 3, 2009, meeting.

The DOT&PF provided NMFS, USFWS, ADF&G, and USACE with a draft EFH Assessment for review on February 8, 2012. DOT&PF then met with representatives from NMFS, USFWS, and ADFG February 16, 2012, to discuss the draft and solicit feedback. DOT&PF addressed the comments received from NMFS and the other agencies to revise and finalize the EFH Assessment.

The DOT&PF met with the IDT team on June 18 and 19, 2013, in the office and in the field to provide a project update and information requested at the last IDT meeting regarding project impacts and mitigation in an office review. Initially the Draft EFH was distributed to NMFS and FWS on May 11, 2012. The Draft EA and Draft EFH were made available for agency review between July 17, 2013 and August 26, 2013.

Based on agency comments, project passing zones were reduced which resulted in additional avoidance and minimization and further reduced impacts to EFH. DOT&PF met with the IDT again on September 30, 2013 to review a proposed revised alignment. Recently, DOT&PF met with NMFS, USFWS, and the USACE on February 13 and March 26, 2014 and with FWS and NMFS to discuss proposed mitigation. On April 4, 2014, the DOT&PF met with the ADF&G in Haines to discuss:

1. Chilkat River Fish dispersion See Appendix G, and
2. appropriate mitigation details for fill in the Chilkat River.

DOT&PF met again in Juneau on July 24 and 25 to discuss details of a revised EFH.

7.0 AGENCY DETERMINATION

Based on the project design, DOT&PF on behalf of FHWA believes that:

1. due to the proposed conservation measures, short-term impacts from construction activities would be temporary and minimal, and
2. the avoidance, minimization, and mitigation measures outlined in Section 4 of this document would, at least, offset the quality and quantity of EFH and, consequently, the overall effects would not be adverse.

8.0 REFERENCES

- ADF&G. 2012. *Alaska Department of Fish and Game Species*. Accessed March 20, 2012, at <http://www.adfg.alaska.gov/index.cfm?adfg=animals.listfish>.
- Betts, M.F. 1994. *The Subsistence Hooligan Fishery of the Chilkat and Chilkoot Rivers. Technical Paper Number 213*. Alaska Department of Fish and Game Division of Subsistence. Juneau, Alaska.
- Bugliosi, E.F. 1988. *Hydrologic Reconnaissance of the Chilkat River Basin Southeast Alaska, with Special Reference to the Alaska Chilkat Bald Eagle Preserve. U.S. Geological Survey Water-Resources Investigations Report 88-4023*. Prepared in cooperation with Alaska Department of Natural Resources Division of Geological and Geophysical Surveys. Anchorage, Alaska.
- DOT&PF /ADF&G 2001. *Memorandum of Agreement (MOA) for the Design, Permitting, and Construction of Culverts for Fish Passage* available at <http://www.dot.state.ak.us/stwddes/desenviron/resources/memos.shtml>
- DOWL HKM. 2010. *Wetland Impact Assessment and Compensatory Wetland Mitigation Plan Haines Highway Milepost 3.5 to 25.3*. January 2010.
- DOWL HKM. 2010a. Preliminary Engineering Report, Haines Highway MP 3.5 to 25.3. February 2010.
- Interfluve. 2006. *Haines Highway Milepost 3.5 to 25.3 Stream and Habitat Inventory*. July 2006.
- Interfluve. 2009. *Hydrology and Hydraulics Report Haines Highway Milepost 3.5 to 25.3*. October 2009.
- Interfluve. 2012. *Haines Highway Milepost 3.5 to 25.3 Conceptual Mitigation Opportunities*. January 2012.
- NOAA. 2012. NOAA Fisheries *Office of Protected Resources*. Accessed March 20, 2012, at <http://www.nmfs.noaa.gov/pr/species/fish/>.
- Tousil, Robert, PE. 2013. *Technical Memo Haines Highway MP 3.5 to MP 12 Bank Stabilization Structures* November 29, 2013.
- USACE. 2003. *Effects of Riprap on Riverine and Riparian Ecosystems*. USACE, Engineer Research and Development Center, Wetlands Regulatory Assistance Program. ERDC/EL TR-0304.

APPENDICES

Appendix A.....	EFH Impacts
Appendix B.....	Stream and Habitat Inventory (available on attached CD)
Appendix C.....	Hydrology and Hydraulics Report (available on attached CD)
Appendix D.....	Stream Habitat Mitigation Plan
Appendix E.....	Proposed Culvert Upgrades
Appendix F.....	Bank Stabilization Measures
Appendix G.....	King and Coho Smolt Distribution in the Chilkat River

APPENDIX A

EFH Impacts

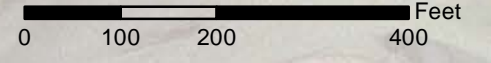
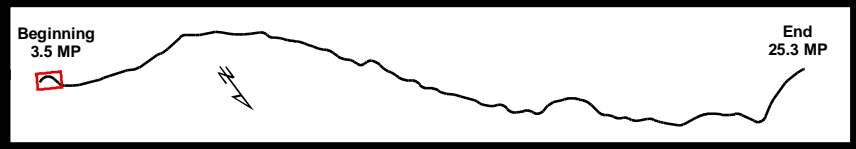

Wetland Type	--- Proposed Centerline	--- Existing Streams
PEM1H	▭ Proposed Cut & Fill Limits	--- MP 4 Stream Relocation
PSS1H	▭ Previous EA Cut & Fill Limits	--- Stream Impacts
R3OW	● Mile Post Points	
	⊘ Chilkat River Impacted Polygon ID	
	⊘ Stream ID Number	

*Darker wetland colors show impacted wetlands. Lighter wetland colors show the extent of wetlands mapped within the 2006 study area. Reference EA acronym list for NWI types.

EFH IMPACTS

TS 28/29/30 S, R 56/57/58/59 E,
Copper River Meridian, Alaska



STATE OF ALASKA
DEPARTMENT OF TRANSPORTATION
AND PUBLIC FACILITIES
DOT & PF Project No. 68606
HAINES HIGHWAY
MILEPOST 3.5 - 25.3
Haines, Alaska

DATE: November 17, 2014 Figure Set 1 (01 OF 34)

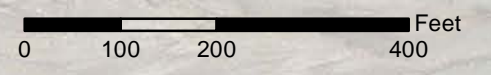
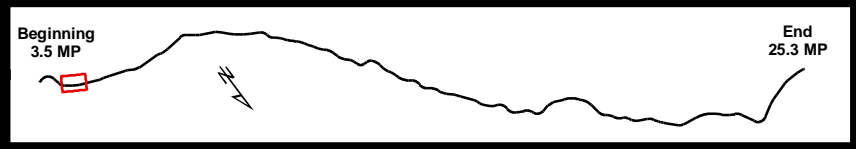

- | | | |
|---------------------|-------------------------------------|--------------------------------------|
| Wetland Type | --- Proposed Centerline | --- Existing Streams |
| PEM1H | ▭ Proposed Cut & Fill Limits | --- Proposed Stream Mitigation |
| PSS1H | ▭ Previous EA Cut & Fill Limits | --- Stream Impacts |
| R3OW | ● Mile Post Points | --- Upgraded to Fish Passage Culvert |
| | ⊘ Chilkat River Impacted Polygon ID | |
| | ⊘ Stream ID Number | |

*Darker wetland colors show impacted wetlands. Lighter wetland colors show the extent of wetlands mapped within the 2006 study area. Reference EA acronym list for NWI types.

EFH IMPACTS

TS 28/29/30 S, R 56/57/58/59 E,
Copper River Meridian, Alaska



STATE OF ALASKA
DEPARTMENT OF TRANSPORTATION
AND PUBLIC FACILITIES
DOT & PF Project No. 68606
HAINES HIGHWAY
MILEPOST 3.5 - 25.3
Haines, Alaska

DATE: November 17, 2014 Figure Set 1 (02 OF 34)

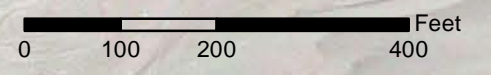
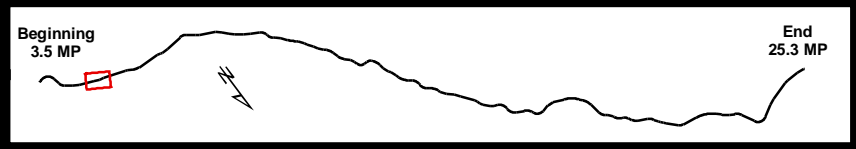

- | | | | |
|---------------------|-----------------------------------|----------------------|----------------------------------|
| Wetland Type | --- Proposed Centerline | --- Existing Streams | Vegetative Riprap (Interfluvium) |
| PEM1H | Proposed Cut & Fill Limits | Stream Impacts | |
| PSS1H | Previous EA Cut & Fill Limits | | |
| R3OW | Mile Post Points | | |
| | Chilkat River Impacted Polygon ID | | |
| | Stream ID Number | | |

*Darker wetland colors show impacted wetlands. Lighter wetland colors show the extent of wetlands mapped within the 2006 study area. Reference EA acronym list for NWI types.

EFH IMPACTS

TS 28/29/30 S, R 56/57/58/59 E,
Copper River Meridian, Alaska



STATE OF ALASKA
DEPARTMENT OF TRANSPORTATION
AND PUBLIC FACILITIES
DOT & PF Project No. 68606
HAINES HIGHWAY
MILEPOST 3.5 - 25.3

Haines, Alaska

DATE: November 17, 2014

Figure Set 1 (03 OF 34)

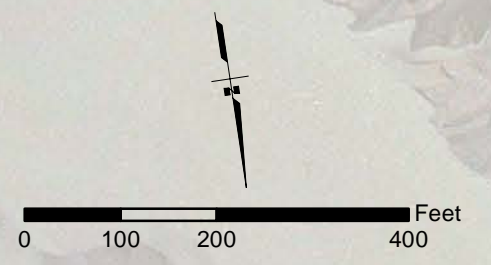
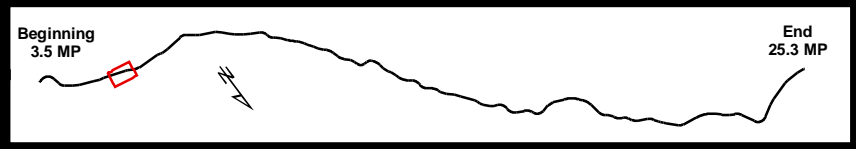

Wetland Type	--- Proposed Centerline	--- Existing Streams	▨ Vegetative Riprap (Interfluv)
PEM1H	▭ Proposed Cut & Fill Limits	▭ Upgraded Culvert (non-anadromous streams)	
PFO1C	▭ Previous EA Cut & Fill Limits	▭ Upgraded to Fish Passage Culvert	
PSS1H	● Mile Post Points		
R3OW	# Chilkat River Impacted Polygon ID		
	● Stream ID Number		

*Darker wetland colors show impacted wetlands. Lighter wetland colors show the extent of wetlands mapped within the 2006 study area. Reference EA acronym list for NWI types.

EFH IMPACTS

TS 28/29/30 S, R 56/57/58/59 E,
Copper River Meridian, Alaska



STATE OF ALASKA
DEPARTMENT OF TRANSPORTATION
AND PUBLIC FACILITIES
DOT & PF Project No. 68606
HAINES HIGHWAY
MILEPOST 3.5 - 25.3
Haines, Alaska

DATE: November 17, 2014 Figure Set 1 (04 OF 34)

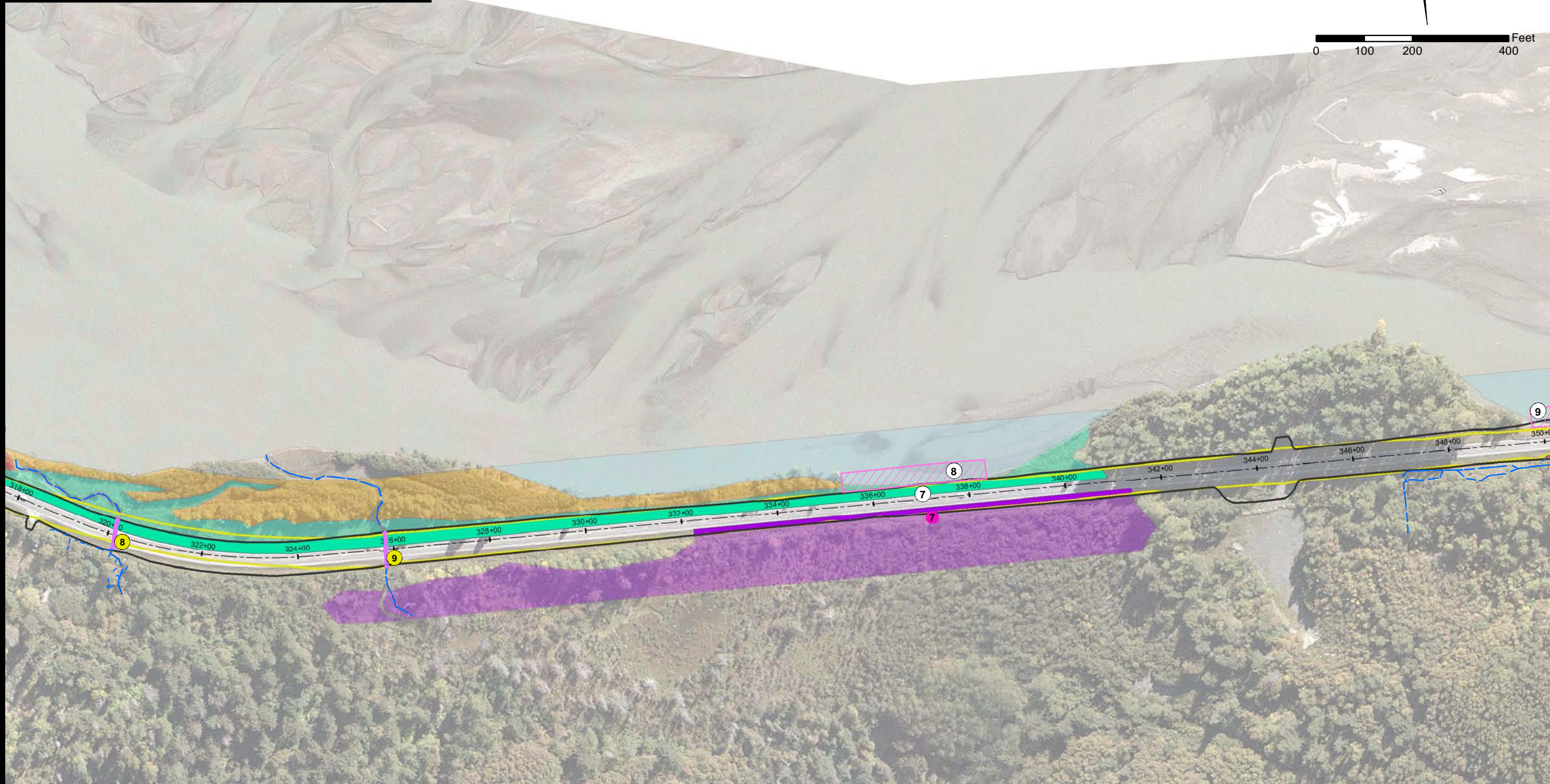
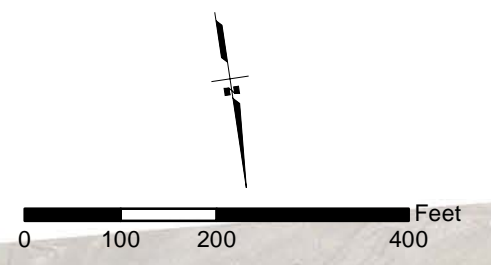
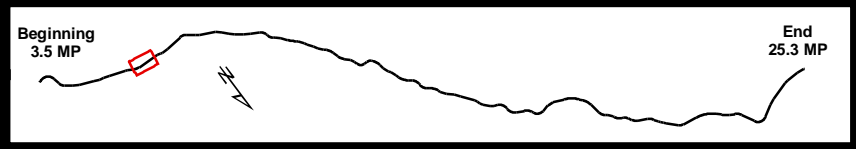

Wetland Type	Proposed Centerline	Existing Streams	Vegetative Riprap (Interfluvial)
PEM1H	Proposed Cut & Fill Limits	Stream Impacts	
PFO1C	Previous EA Cut & Fill Limits	Upgraded to Fish Passage Culvert	
PSS1E	Mile Post Points		
PSS1H	Chilkat River Impacted Polygon ID		
R3OW	Stream ID Number		

*Darker wetland colors show impacted wetlands. Lighter wetland colors show the extent of wetlands mapped within the 2006 study area. Reference EA acronym list for NWI types.

EFH IMPACTS

TS 28/29/30 S, R 56/57/58/59 E,
Copper River Meridian, Alaska



STATE OF ALASKA
DEPARTMENT OF TRANSPORTATION
AND PUBLIC FACILITIES
DOT & PF Project No. 68606
HAINES HIGHWAY
MILEPOST 3.5 - 25.3
Haines, Alaska

DATE: November 17, 2014 Figure Set 1 (05 OF 34)

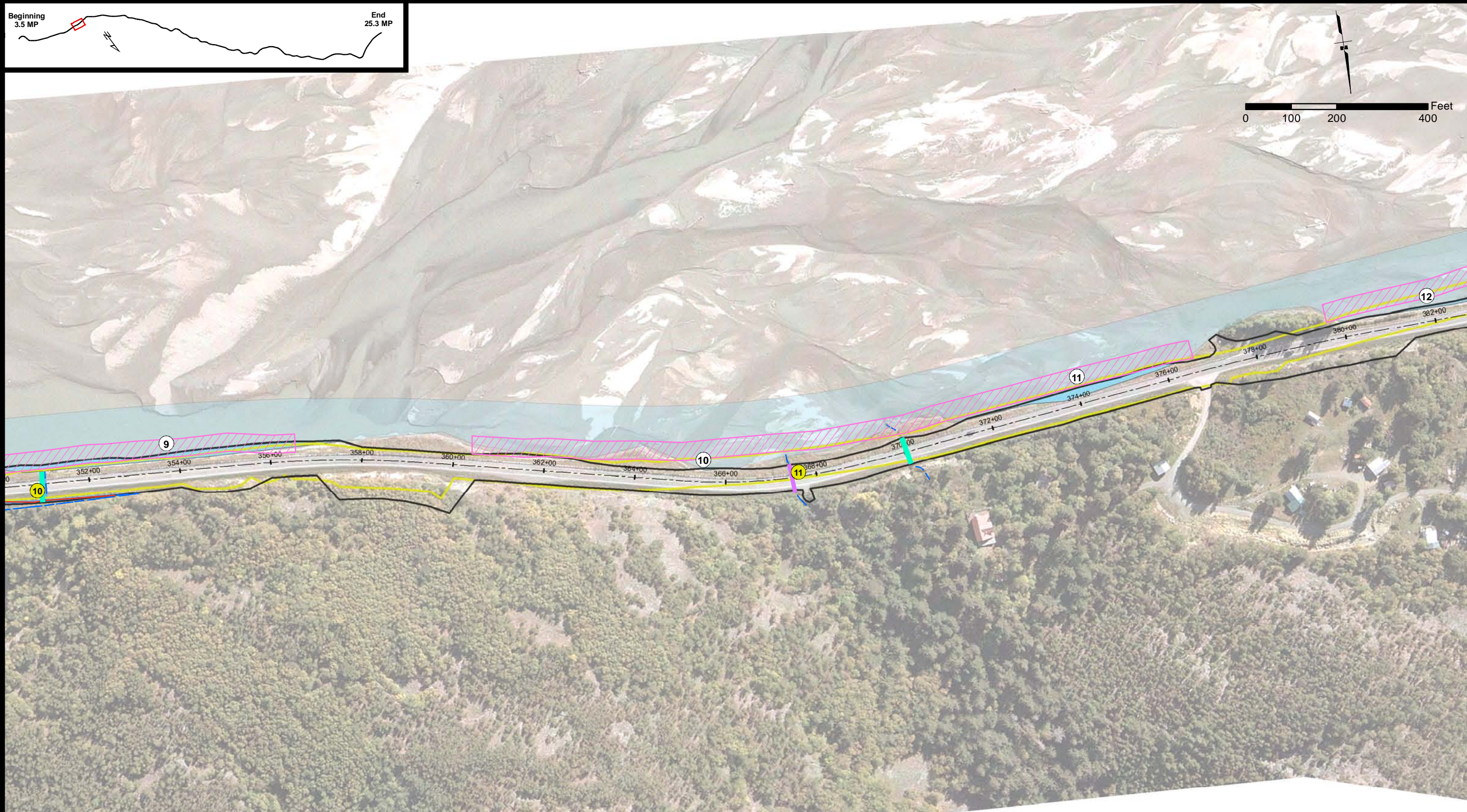
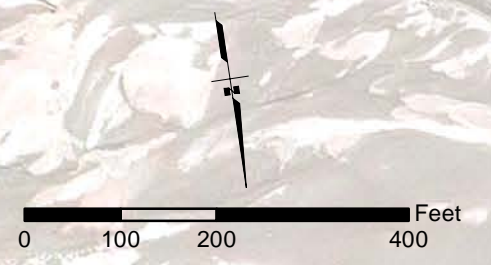
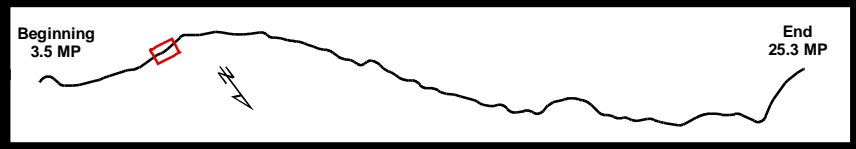

Wetland Type	--- Proposed Centerline	--- Existing Streams	▨ Vegetative Riprap (Interfluvium)
■ R3OW	▭ Proposed Cut & Fill Limits	--- Stream Impacts	
	▭ Previous EA Cut & Fill Limits	--- Upgraded Culvert (non-anadromous streams)	
	● Mile Post Points	--- Upgraded to Fish Passage Culvert	
	⊕ Chilkat River Impacted Polygon ID		
	⊕ Stream ID Number		

*Darker wetland colors show impacted wetlands. Lighter wetland colors show the extent of wetlands mapped within the 2006 study area. Reference EA acronym list for NWI types.

EFH IMPACTS

TS 28/29/30 S, R 56/57/58/59 E,
Copper River Meridian, Alaska



STATE OF ALASKA
DEPARTMENT OF TRANSPORTATION
AND PUBLIC FACILITIES
DOT & PF Project No. 68606
HAINES HIGHWAY
MILEPOST 3.5 - 25.3
Haines, Alaska

DATE: November 17, 2014 Figure Set 1 (06 OF 34)

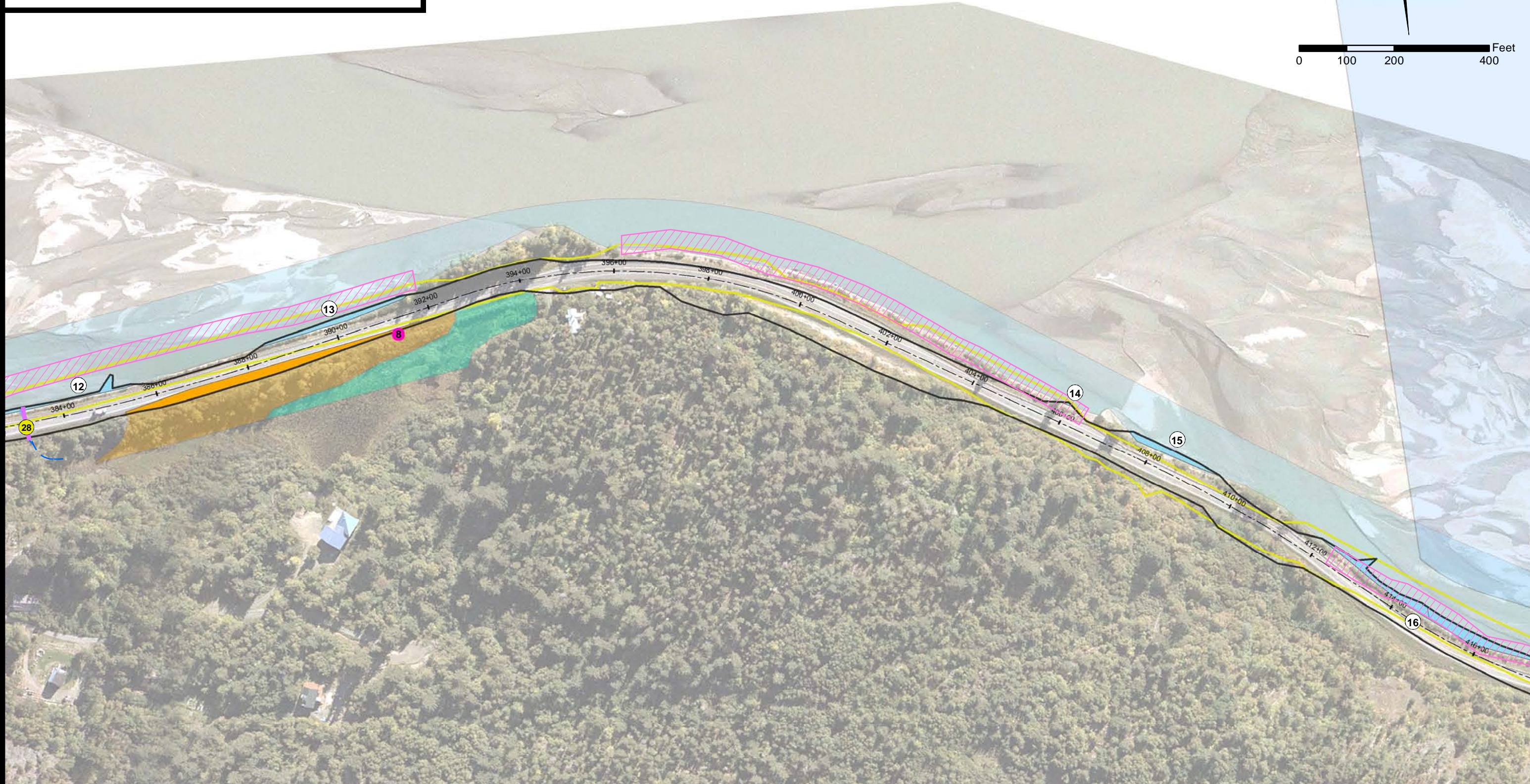
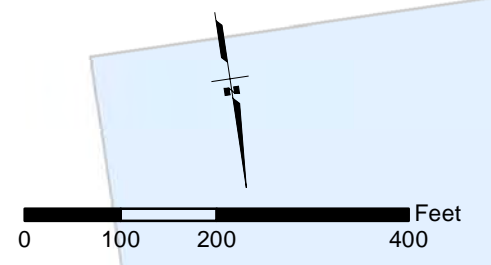
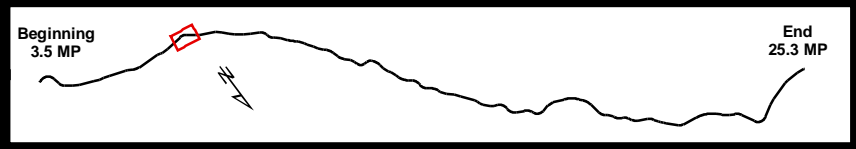

- | | | | |
|---------------------|-------------------------------------|--------------------------------------|---------------------------------|
| Wetland Type | --- Proposed Centerline | --- Existing Streams | ▨ Vegetative Riprap (Interfluv) |
| PEM1H | ▭ Proposed Cut & Fill Limits | --- Upgraded to Fish Passage Culvert | |
| PSS1H | ▭ Previous EA Cut & Fill Limits | | |
| R3OW | ● Mile Post Points | | |
| | ⊘ Chilkat River Impacted Polygon ID | | |
| | ⊘ Stream ID Number | | |

*Darker wetland colors show impacted wetlands. Lighter wetland colors show the extent of wetlands mapped within the 2006 study area. Reference EA acronym list for NWI types.

EFH IMPACTS

TS 28/29/30 S, R 56/57/58/59 E,
Copper River Meridian, Alaska



STATE OF ALASKA
DEPARTMENT OF TRANSPORTATION
AND PUBLIC FACILITIES
DOT & PF Project No. 68606
HAINES HIGHWAY
MILEPOST 3.5 - 25.3

Haines, Alaska

DATE: November 17, 2014

Figure Set 1 (07 OF 34)

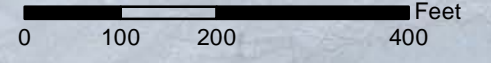

- | | | | |
|-------------------------------------|---------------------------------|---|------------------------------------|
| Wetland Type | --- Proposed Centerline | --- Existing Streams | ▨ Vegetative Riprap (Interfluvium) |
| R3OW | ▭ Proposed Cut & Fill Limits | ▬ Upgraded Culvert (non-anadromous streams) | |
| | ▭ Previous EA Cut & Fill Limits | | |
| ● Mile Post Points | | | |
| # Chilkat River Impacted Polygon ID | | | |
| # Stream ID Number | | | |

*Darker wetland colors show impacted wetlands. Lighter wetland colors show the extent of wetlands mapped within the 2006 study area. Reference EA acronym list for NWI types.

EFH IMPACTS

TS 28/29/30 S, R 56/57/58/59 E,
Copper River Meridian, Alaska



STATE OF ALASKA
DEPARTMENT OF TRANSPORTATION
AND PUBLIC FACILITIES
DOT & PF Project No. 68606
HAINES HIGHWAY
MILEPOST 3.5 - 25.3

Haines, Alaska

DATE: November 17, 2014

Figure Set 1 (08 OF 34)

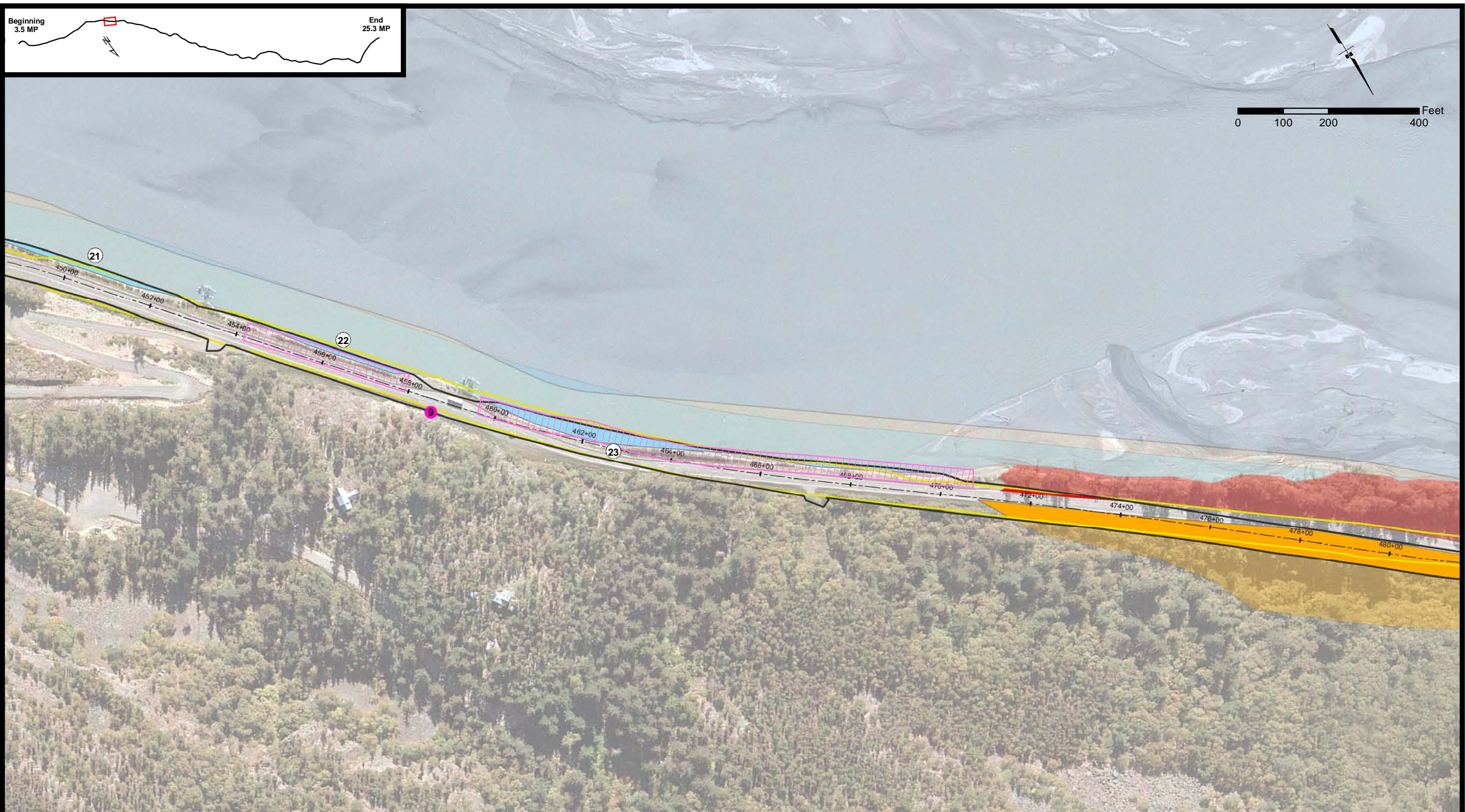
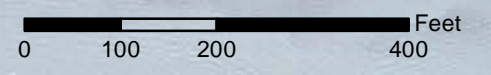
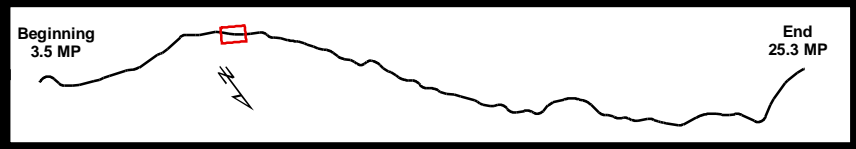

- | | | | |
|---------------------|-----------------------------------|----------------------|-------------------------------|
| Wetland Type | --- Proposed Centerline | --- Existing Streams | Vegetative Riprap (Interfluv) |
| PFO1C | Proposed Cut & Fill Limits | | |
| PSS1H | Previous EA Cut & Fill Limits | | |
| R3OW | Mile Post Points | | |
| | Chilkat River Impacted Polygon ID | | |
| | Stream ID Number | | |

*Darker wetland colors show impacted wetlands. Lighter wetland colors show the extent of wetlands mapped within the 2006 study area. Reference EA acronym list for NWI types.

EFH IMPACTS

TS 28/29/30 S, R 56/57/58/59 E,
Copper River Meridian, Alaska



STATE OF ALASKA
DEPARTMENT OF TRANSPORTATION
AND PUBLIC FACILITIES
DOT & PF Project No. 68606
HAINES HIGHWAY
MILEPOST 3.5 - 25.3

Haines, Alaska

DATE: November 17, 2014

Figure Set 1 (09 OF 34)

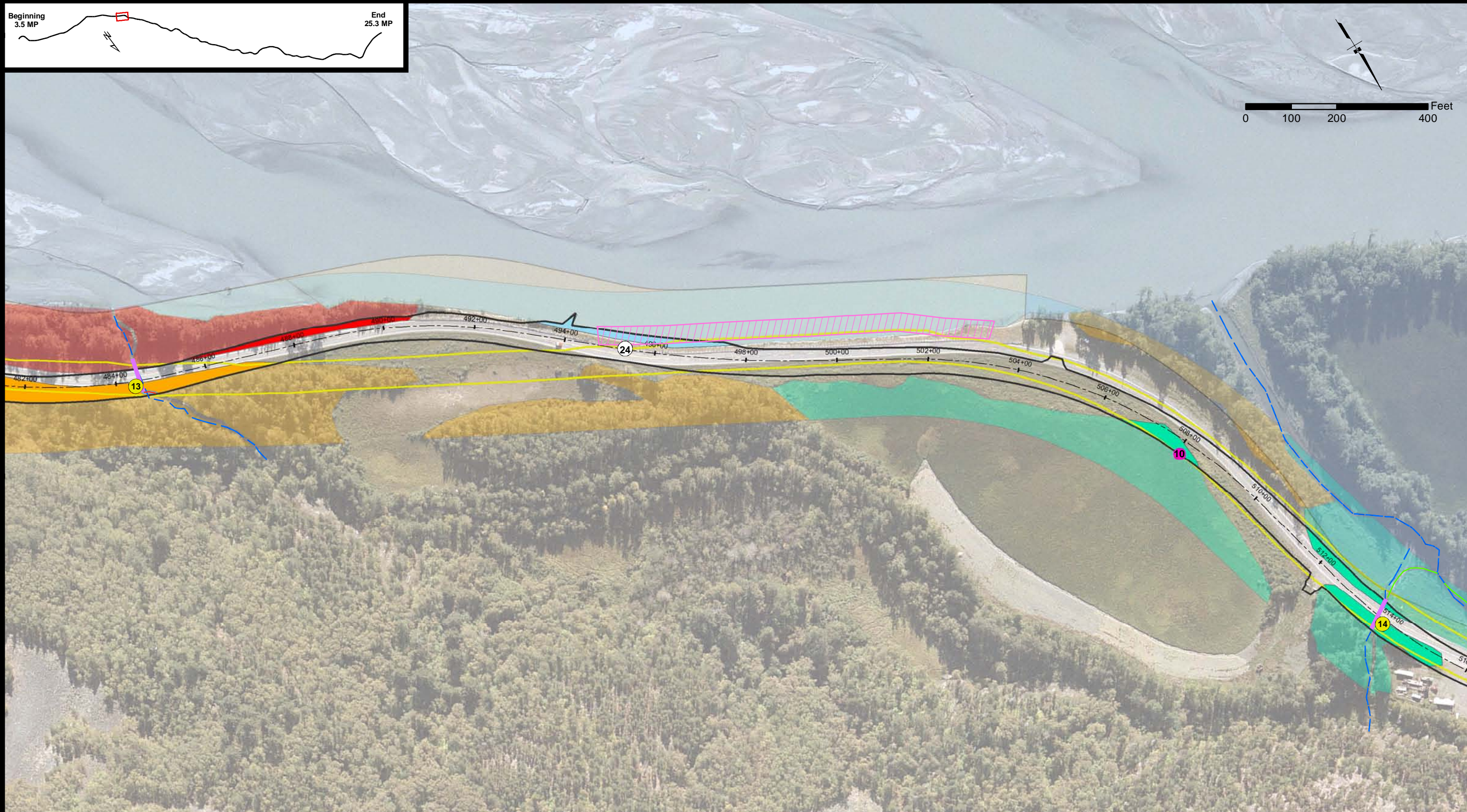
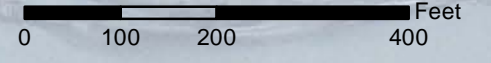
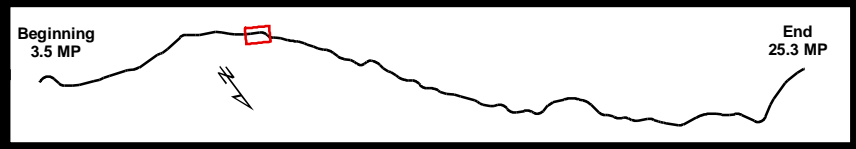

- | | | | |
|---------------------|-------------------------------------|--------------------------------------|------------------------------------|
| Wetland Type | --- Proposed Centerline | --- Existing Streams | ▨ Vegetative Riprap (Interfluvium) |
| PEM1H | ▭ Proposed Cut & Fill Limits | --- Proposed Stream Mitigation | |
| PFO1C | ▭ Previous EA Cut & Fill Limits | --- Stream Impacts | |
| PSS1H | ● Mile Post Points | --- Upgraded to Fish Passage Culvert | |
| R3OW | ⊘ Chilkat River Impacted Polygon ID | | |
| | ⊘ Stream ID Number | | |

*Darker wetland colors show impacted wetlands. Lighter wetland colors show the extent of wetlands mapped within the 2006 study area. Reference EA acronym list for NWI types.

EFH IMPACTS

TS 28/29/30 S, R 56/57/58/59 E,
Copper River Meridian, Alaska



STATE OF ALASKA
DEPARTMENT OF TRANSPORTATION
AND PUBLIC FACILITIES
DOT & PF Project No. 68606
HAINES HIGHWAY
MILEPOST 3.5 - 25.3

Haines, Alaska

DATE: November 17, 2014

Figure Set 1 (10 OF 34)

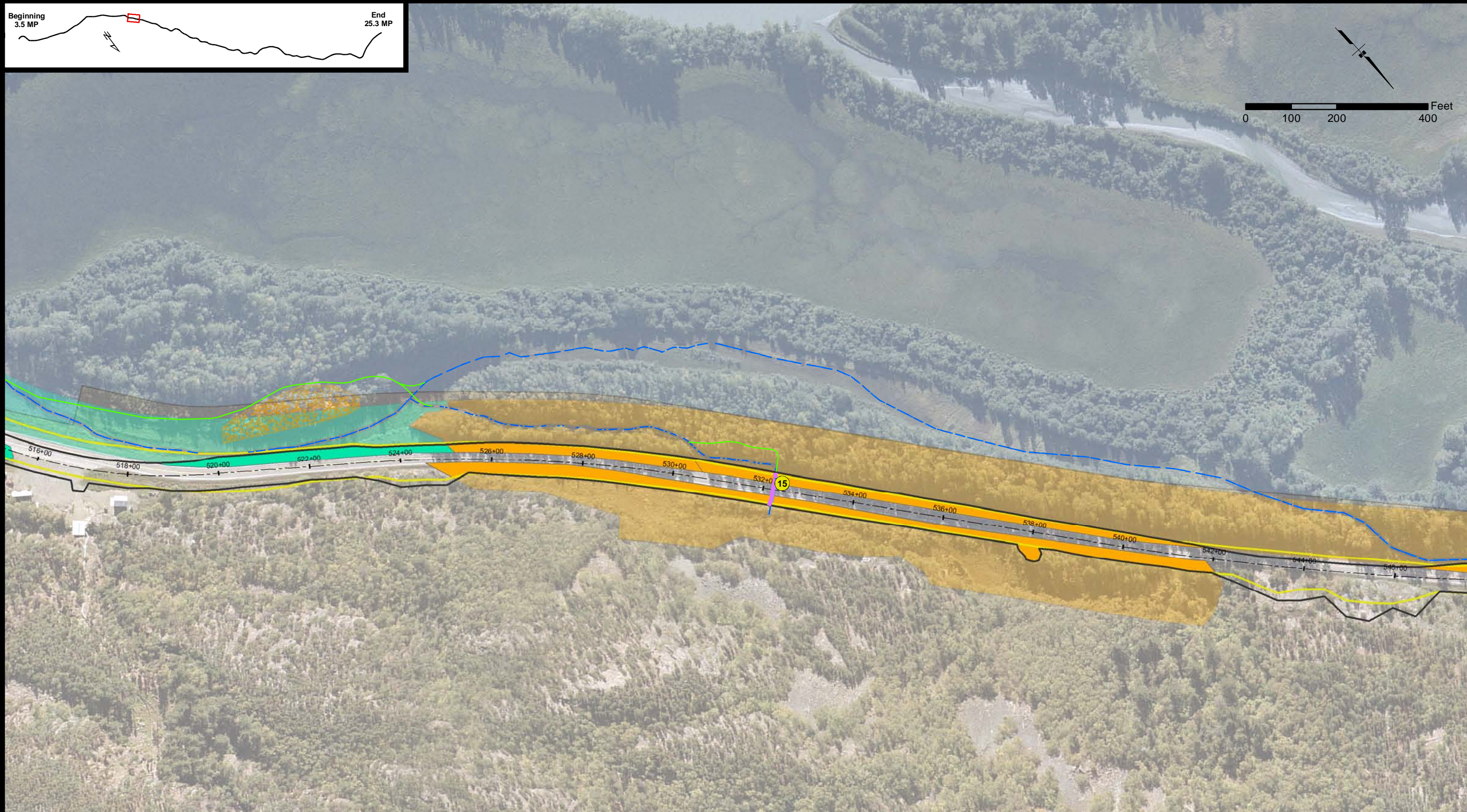
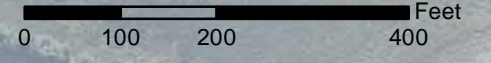

- | | | | |
|---------------------|-------------------------------------|----------------------------------|----------------------|
| Wetland Type | --- Proposed Centerline | --- Existing Streams | Protected Vegetation |
| PEM1H | Proposed Cut & Fill Limits | Proposed Stream Mitigation | |
| PSS1H | Previous EA Cut & Fill Limits | Upgraded to Fish Passage Culvert | |
| | ● Mile Post Points | | |
| | ⊘ Chilkat River Impacted Polygon ID | | |
| | ⊙ Stream ID Number | | |

**Darker wetland colors show impacted wetlands. Lighter wetland colors show the extent of wetlands mapped within the 2006 study area. Reference EA acronym list for NWI types.*

EFH IMPACTS

TS 28/29/30 S, R 56/57/58/59 E,
Copper River Meridian, Alaska



STATE OF ALASKA
DEPARTMENT OF TRANSPORTATION
AND PUBLIC FACILITIES
DOT & PF Project No. 68606
HAINES HIGHWAY
MILEPOST 3.5 - 25.3

Haines, Alaska

DATE: November 17, 2014

Figure Set 1 (11 OF 34)

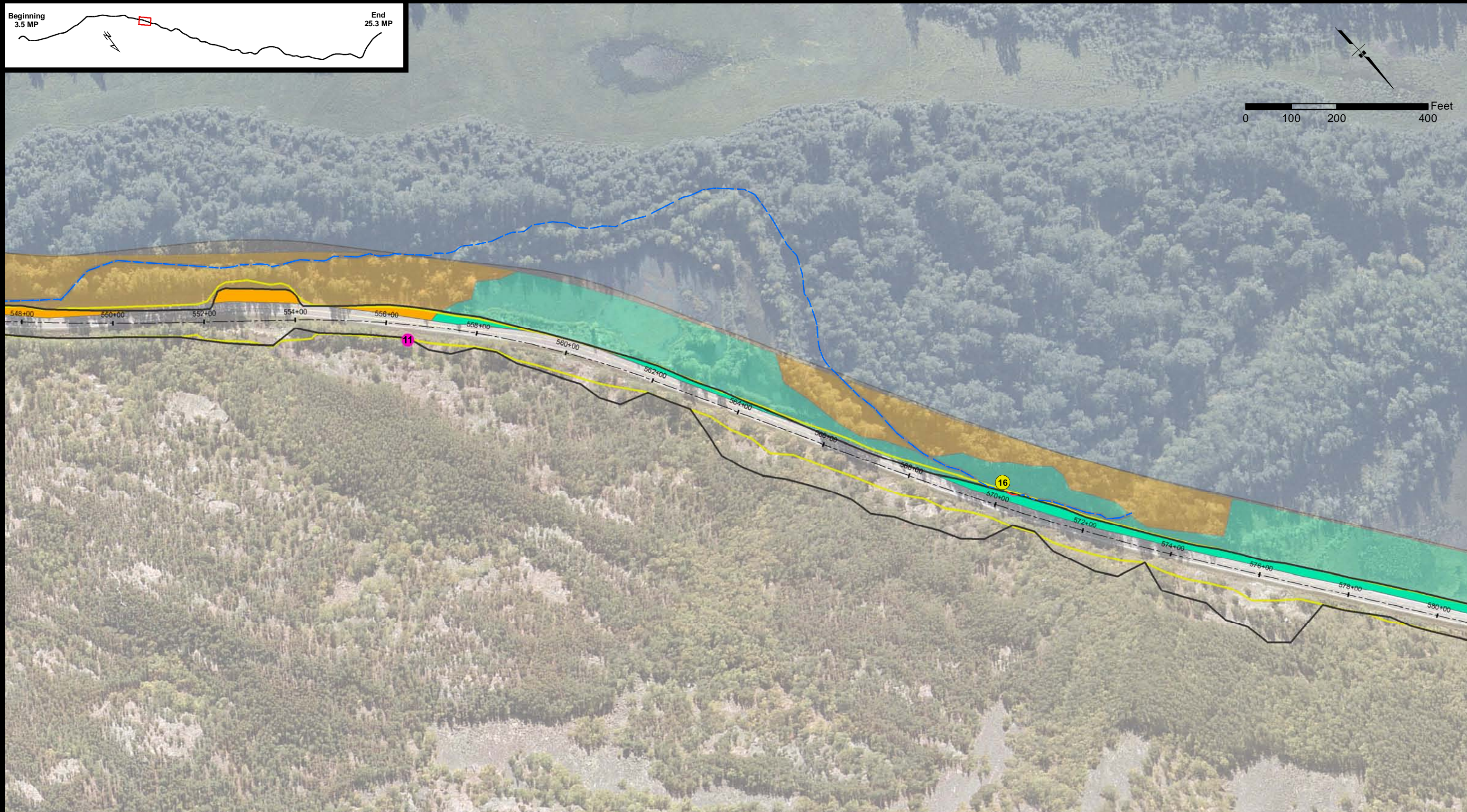
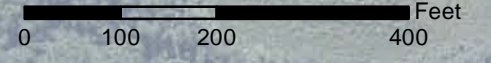
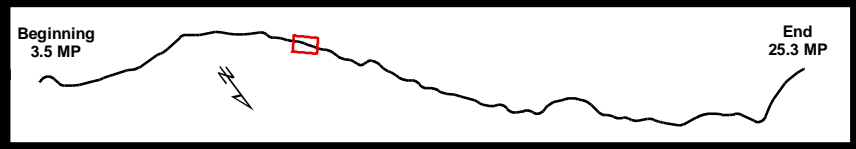

- | | | |
|---------------------|-------------------------------------|----------------------|
| Wetland Type | --- Proposed Centerline | --- Existing Streams |
| PEM1H | ▭ Proposed Cut & Fill Limits | --- Stream Impacts |
| PSS1H | ▭ Previous EA Cut & Fill Limits | |
| | ● Mile Post Points | |
| | # Chilkat River Impacted Polygon ID | |
| | # Stream ID Number | |

*Darker wetland colors show impacted wetlands. Lighter wetland colors show the extent of wetlands mapped within the 2006 study area. Reference EA acronym list for NWI types.

EFH IMPACTS

TS 28/29/30 S, R 56/57/58/59 E,
Copper River Meridian, Alaska



STATE OF ALASKA
DEPARTMENT OF TRANSPORTATION
AND PUBLIC FACILITIES
DOT & PF Project No. 68606
HAINES HIGHWAY
MILEPOST 3.5 - 25.3

Haines, Alaska

DATE: November 17, 2014

Figure Set 1 (12 OF 34)

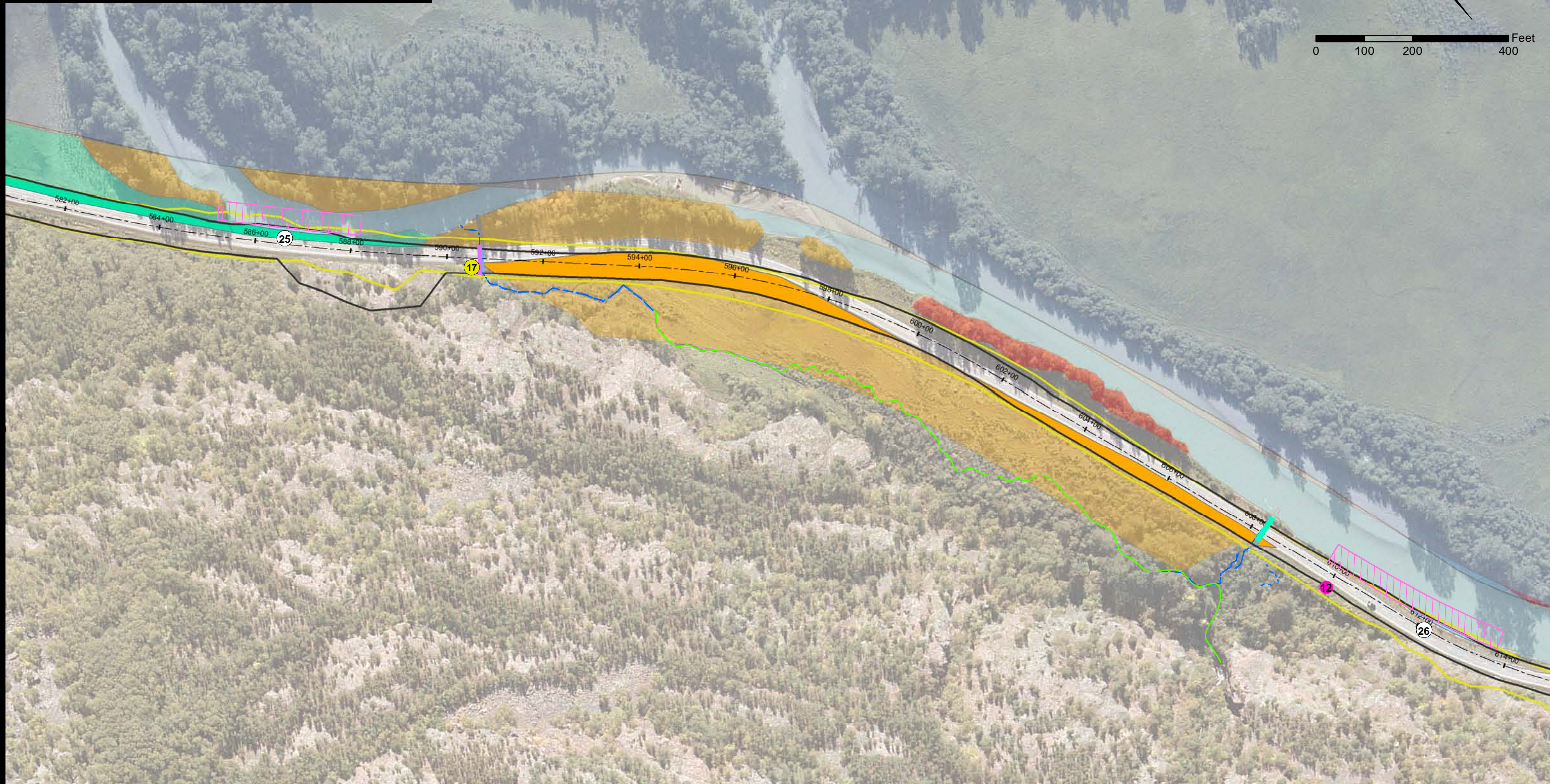
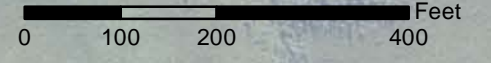
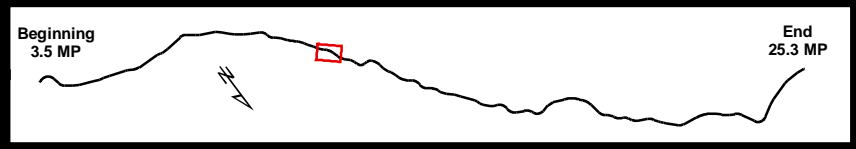

Wetland Type	--- Proposed Centerline	--- Existing Streams	▨ Vegetative Riprap (Interfluvium)
PEM1H	▭ Proposed Cut & Fill Limits	--- Proposed Stream Mitigation	
PFO1C	▭ Previous EA Cut & Fill Limits	--- Upgraded Culvert (non-anadromous streams)	
PSS1H	● Mile Post Points	--- Upgraded to Fish Passage Culvert	
R3OW	⊘ Chilkat River Impacted Polygon ID		
	⊘ Stream ID Number		

*Darker wetland colors show impacted wetlands. Lighter wetland colors show the extent of wetlands mapped within the 2006 study area. Reference EA acronym list for NWI types.

EFH IMPACTS

TS 28/29/30 S, R 56/57/58/59 E,
Copper River Meridian, Alaska



STATE OF ALASKA
DEPARTMENT OF TRANSPORTATION
AND PUBLIC FACILITIES
DOT & PF Project No. 68606
HAINES HIGHWAY
MILEPOST 3.5 - 25.3
Haines, Alaska

DATE: November 17, 2014 Figure Set 1 (13 OF 34)

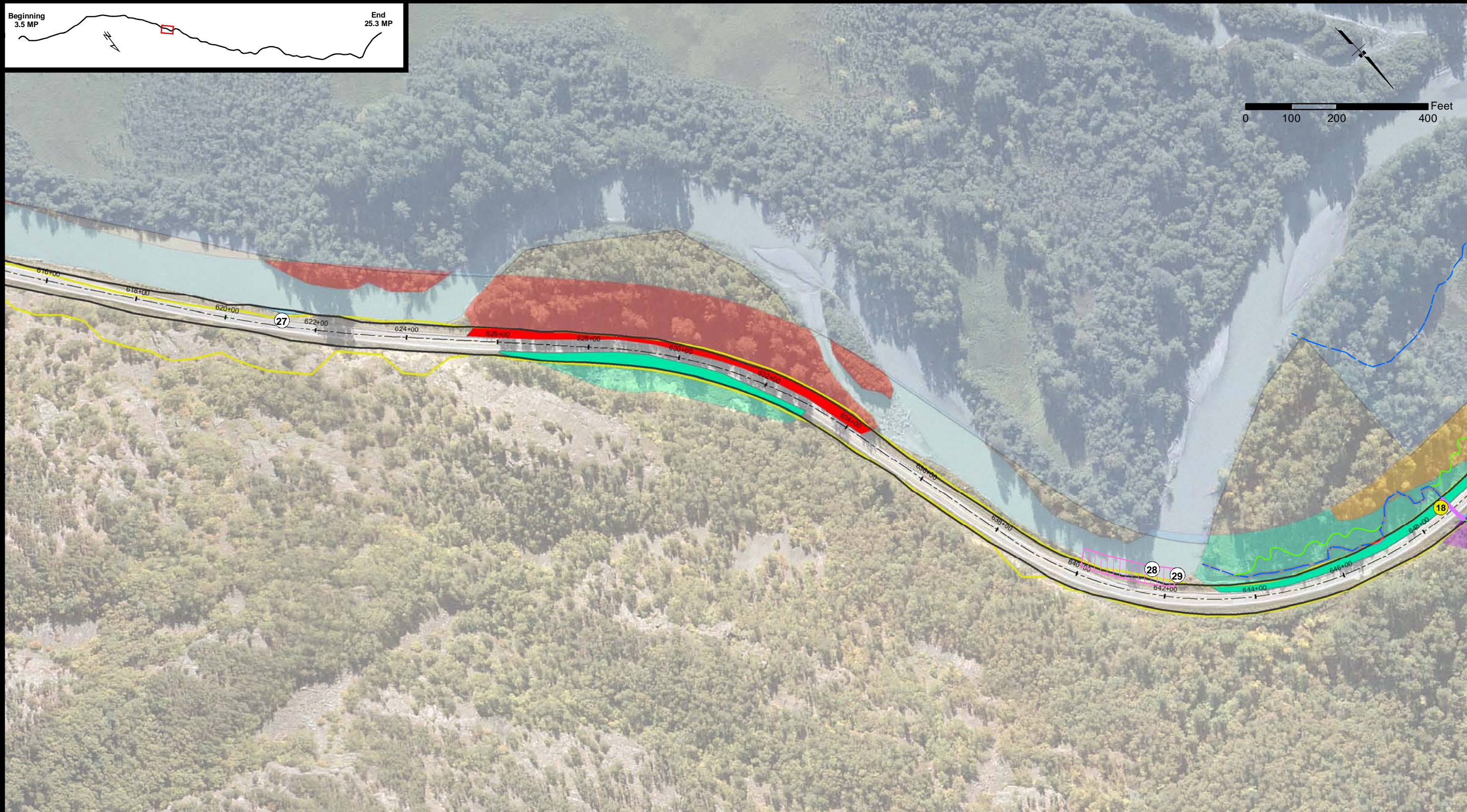
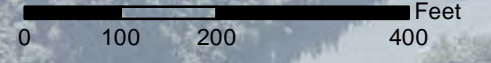
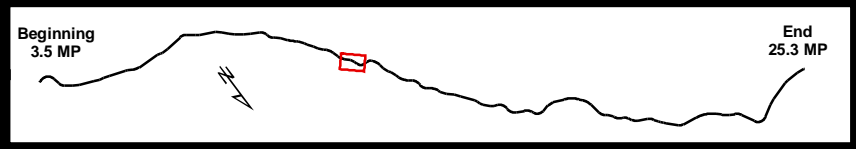

Wetland Type	--- Proposed Centerline	--- Existing Streams	▨ Vegetative Riprap (Interfluvium)
PEM1H	▭ Proposed Cut & Fill Limits	--- Proposed Stream Mitigation	
PFO1C	▭ Previous EA Cut & Fill Limits	--- Stream Impacts	
PSS1E	● Mile Post Points	--- Upgraded to Fish Passage Culvert	
PSS1H	⊕ Chilkat River Impacted Polygon ID		
R3OW	⊕ Stream ID Number		

*Darker wetland colors show impacted wetlands. Lighter wetland colors show the extent of wetlands mapped within the 2006 study area. Reference EA acronym list for NWI types.

EFH IMPACTS

TS 28/29/30 S, R 56/57/58/59 E,
Copper River Meridian, Alaska



STATE OF ALASKA
DEPARTMENT OF TRANSPORTATION
AND PUBLIC FACILITIES
DOT & PF Project No. 68606
HAINES HIGHWAY
MILEPOST 3.5 - 25.3

Haines, Alaska

DATE: November 17, 2014

Figure Set 1 (14 OF 34)

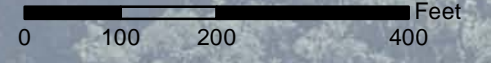
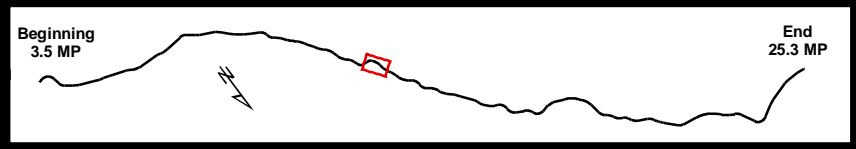

Wetland Type	--- Proposed Centerline	--- Existing Streams	▨ Vegetative Riprap (Interfluvial)
PEM1H	▭ Proposed Cut & Fill Limits	--- Proposed Stream Mitigation	▨ Grade Control
PSS1E	▭ Previous EA Cut & Fill Limits	--- Upgraded to Fish Passage Culvert	
PSS1H	● Mile Post Points		
R3OW	# Chilkat River Impacted Polygon ID		
	● Stream ID Number		

*Darker wetland colors show impacted wetlands. Lighter wetland colors show the extent of wetlands mapped within the 2006 study area. Reference EA acronym list for NWI types.

EFH IMPACTS

TS 28/29/30 S, R 56/57/58/59 E,
Copper River Meridian, Alaska



STATE OF ALASKA
DEPARTMENT OF TRANSPORTATION
AND PUBLIC FACILITIES
DOT & PF Project No. 68606
HAINES HIGHWAY
MILEPOST 3.5 - 25.3
Haines, Alaska

DATE: November 17, 2014 Figure Set 1 (15 OF 34)

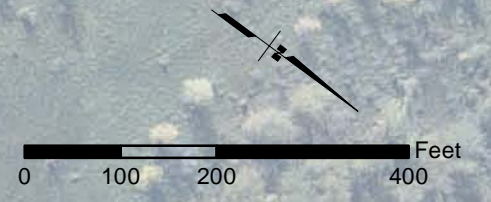
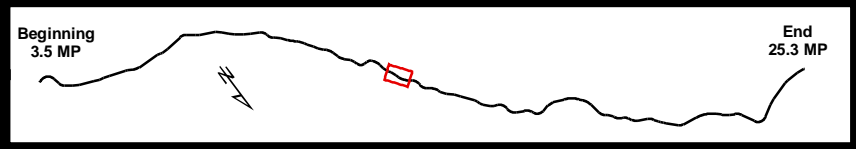

Wetland Type	--- Proposed Centerline	--- Existing Streams	▨ Vegetative Riprap (Interfluvium)
PEM1H	▭ Proposed Cut & Fill Limits	--- Upgraded to Fish Passage Culvert	
PSS1H	▭ Previous EA Cut & Fill Limits		
R3OW	● Mile Post Points		
	# Chilkat River Impacted Polygon ID		
	# Stream ID Number		

*Darker wetland colors show impacted wetlands. Lighter wetland colors show the extent of wetlands mapped within the 2006 study area. Reference EA acronym list for NWI types.

EFH IMPACTS

TS 28/29/30 S, R 56/57/58/59 E,
Copper River Meridian, Alaska



STATE OF ALASKA
DEPARTMENT OF TRANSPORTATION
AND PUBLIC FACILITIES
DOT & PF Project No. 68606
HAINES HIGHWAY
MILEPOST 3.5 - 25.3
Haines, Alaska

DATE: November 17, 2014 Figure Set 1 (16 OF 34)

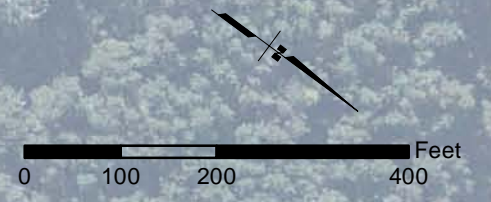
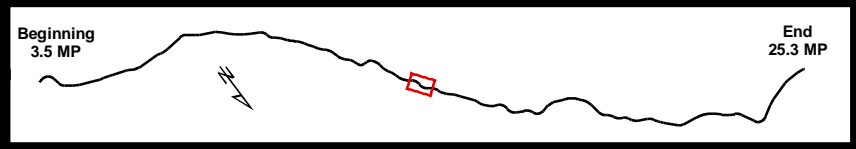

Wetland Type	--- Proposed Centerline	--- Existing Streams	▨ Vegetative Riprap (Interfluv)
PEM1H	▭ Proposed Cut & Fill Limits	— New Culvert	
PSS1H	▭ Previous EA Cut & Fill Limits	— Proposed Stream Mitigation	
R3OW	● Mile Post Points	— Stream Impacts	
	# Chilkat River Impacted Polygon ID	— Upgraded to Fish Passage Culvert	
	# Stream ID Number		

*Darker wetland colors show impacted wetlands. Lighter wetland colors show the extent of wetlands mapped within the 2006 study area. Reference EA acronym list for NWI types.

EFH IMPACTS

TS 28/29/30 S, R 56/57/58/59 E,
Copper River Meridian, Alaska



STATE OF ALASKA
DEPARTMENT OF TRANSPORTATION
AND PUBLIC FACILITIES
DOT & PF Project No. 68606
HAINES HIGHWAY
MILEPOST 3.5 - 25.3
Haines, Alaska

DATE: November 17, 2014 Figure Set 1 (17 OF 34)

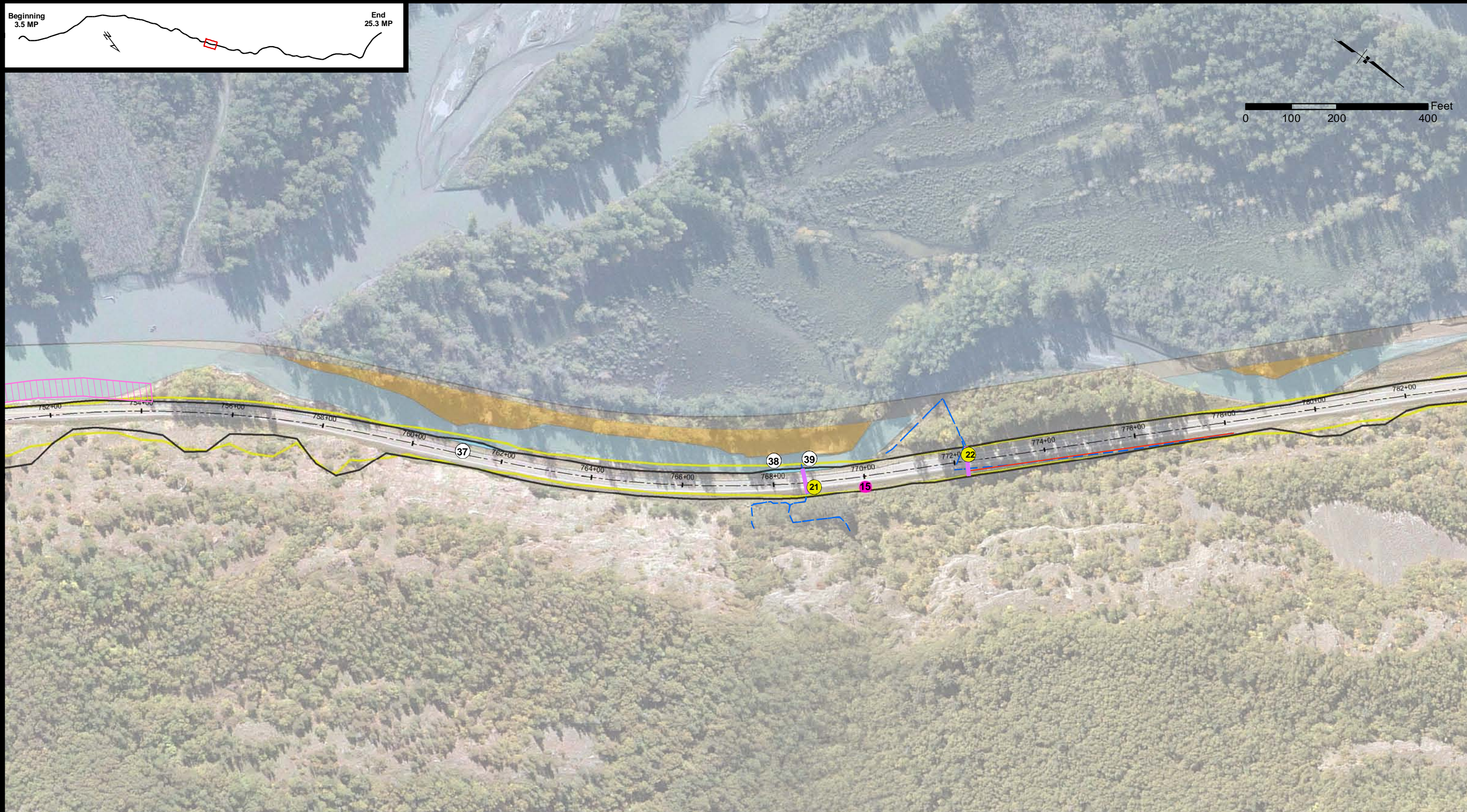
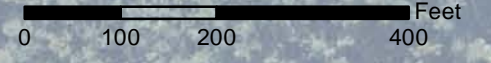
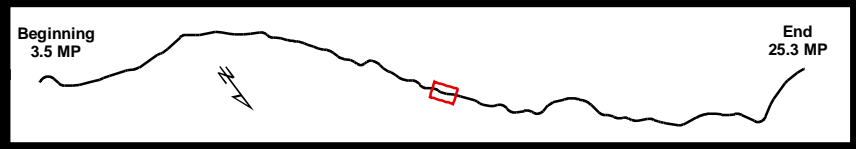

- | | | | |
|-------------------------------------|---------------------------------|--------------------------------------|------------------------------------|
| Wetland Type | --- Proposed Centerline | --- Existing Streams | ▨ Vegetative Riprap (Interfluvial) |
| ■ PSS1H | ▭ Proposed Cut & Fill Limits | --- Stream Impacts | |
| ■ R3OW | ▭ Previous EA Cut & Fill Limits | --- Upgraded to Fish Passage Culvert | |
| ● Mile Post Points | | | |
| # Chilkat River Impacted Polygon ID | | | |
| # Stream ID Number | | | |

*Darker wetland colors show impacted wetlands. Lighter wetland colors show the extent of wetlands mapped within the 2006 study area. Reference EA acronym list for NWI types.

EFH IMPACTS

TS 28/29/30 S, R 56/57/58/59 E,
Copper River Meridian, Alaska



STATE OF ALASKA
DEPARTMENT OF TRANSPORTATION
AND PUBLIC FACILITIES
DOT & PF Project No. 68606
HAINES HIGHWAY
MILEPOST 3.5 - 25.3

Haines, Alaska

DATE: November 17, 2014

Figure Set 1 (18 OF 34)

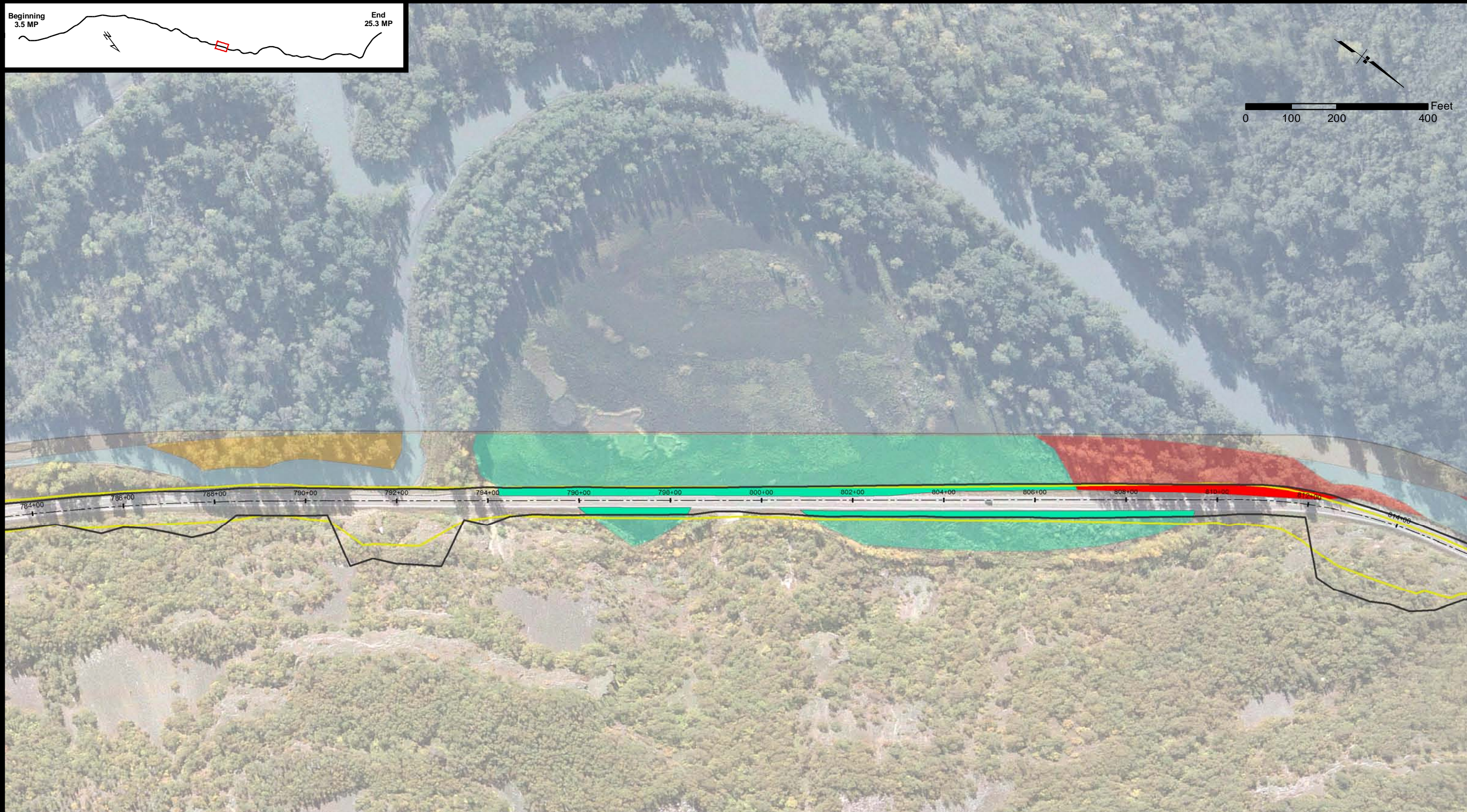
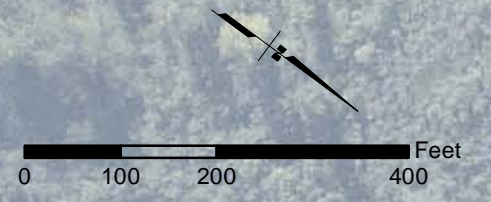
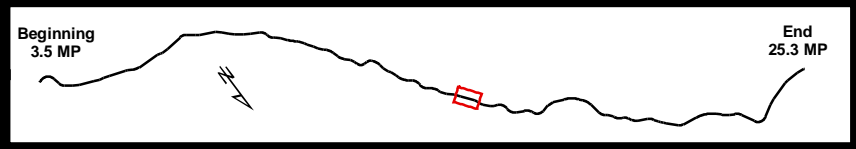

- | | | |
|---------------------|-------------------------------------|----------------------|
| Wetland Type | --- Proposed Centerline | --- Existing Streams |
| PEM1H | ▭ Proposed Cut & Fill Limits | |
| PFO1C | ▭ Previous EA Cut & Fill Limits | |
| PSS1H | ● Mile Post Points | |
| R3OW | ⊕ Chilkat River Impacted Polygon ID | |
| | ⊕ Stream ID Number | |

*Darker wetland colors show impacted wetlands. Lighter wetland colors show the extent of wetlands mapped within the 2006 study area. Reference EA acronym list for NWI types.

EFH IMPACTS

TS 28/29/30 S, R 56/57/58/59 E,
Copper River Meridian, Alaska



STATE OF ALASKA
DEPARTMENT OF TRANSPORTATION
AND PUBLIC FACILITIES
DOT & PF Project No. 68606
HAINES HIGHWAY
MILEPOST 3.5 - 25.3

Haines, Alaska

DATE: November 17, 2014

Figure Set 1 (19 OF 34)

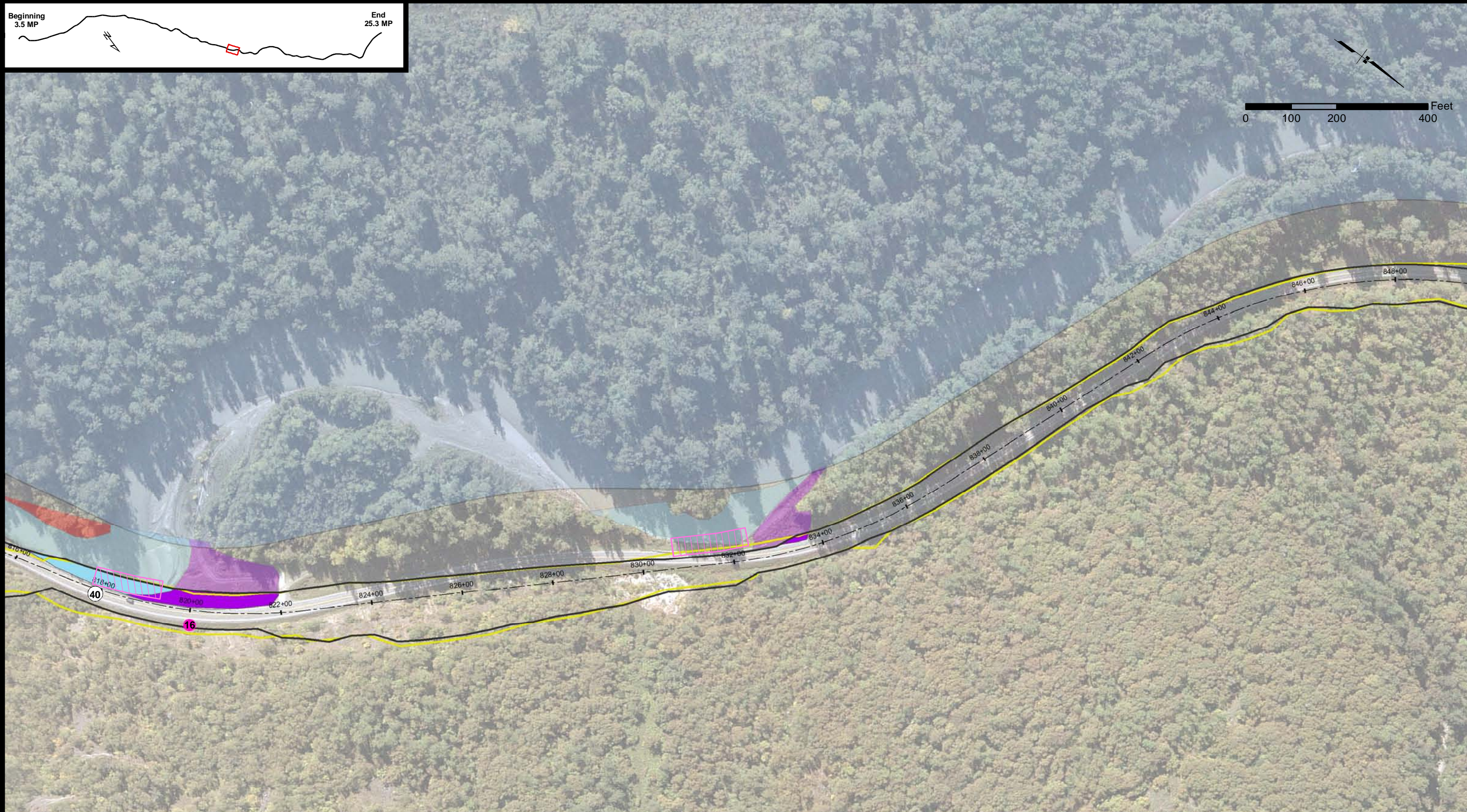
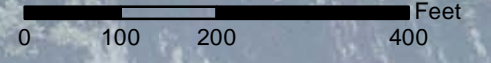
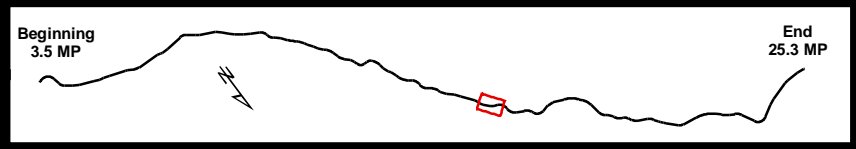

- | | | | |
|---------------------|-----------------------------------|----------------------|----------------------------------|
| Wetland Type | --- Proposed Centerline | --- Existing Streams | Vegetative Riprap (Interfluvium) |
| PFO1C | Proposed Cut & Fill Limits | | |
| PSS1E | Previous EA Cut & Fill Limits | | |
| R3OW | Mile Post Points | | |
| | Chilkat River Impacted Polygon ID | | |
| | Stream ID Number | | |

*Darker wetland colors show impacted wetlands. Lighter wetland colors show the extent of wetlands mapped within the 2006 study area. Reference EA acronym list for NWI types.

EFH IMPACTS

TS 28/29/30 S, R 56/57/58/59 E,
Copper River Meridian, Alaska



STATE OF ALASKA
DEPARTMENT OF TRANSPORTATION
AND PUBLIC FACILITIES
DOT & PF Project No. 68606
HAINES HIGHWAY
MILEPOST 3.5 - 25.3

Haines, Alaska

DATE: November 17, 2014

Figure Set 1 (20 OF 34)

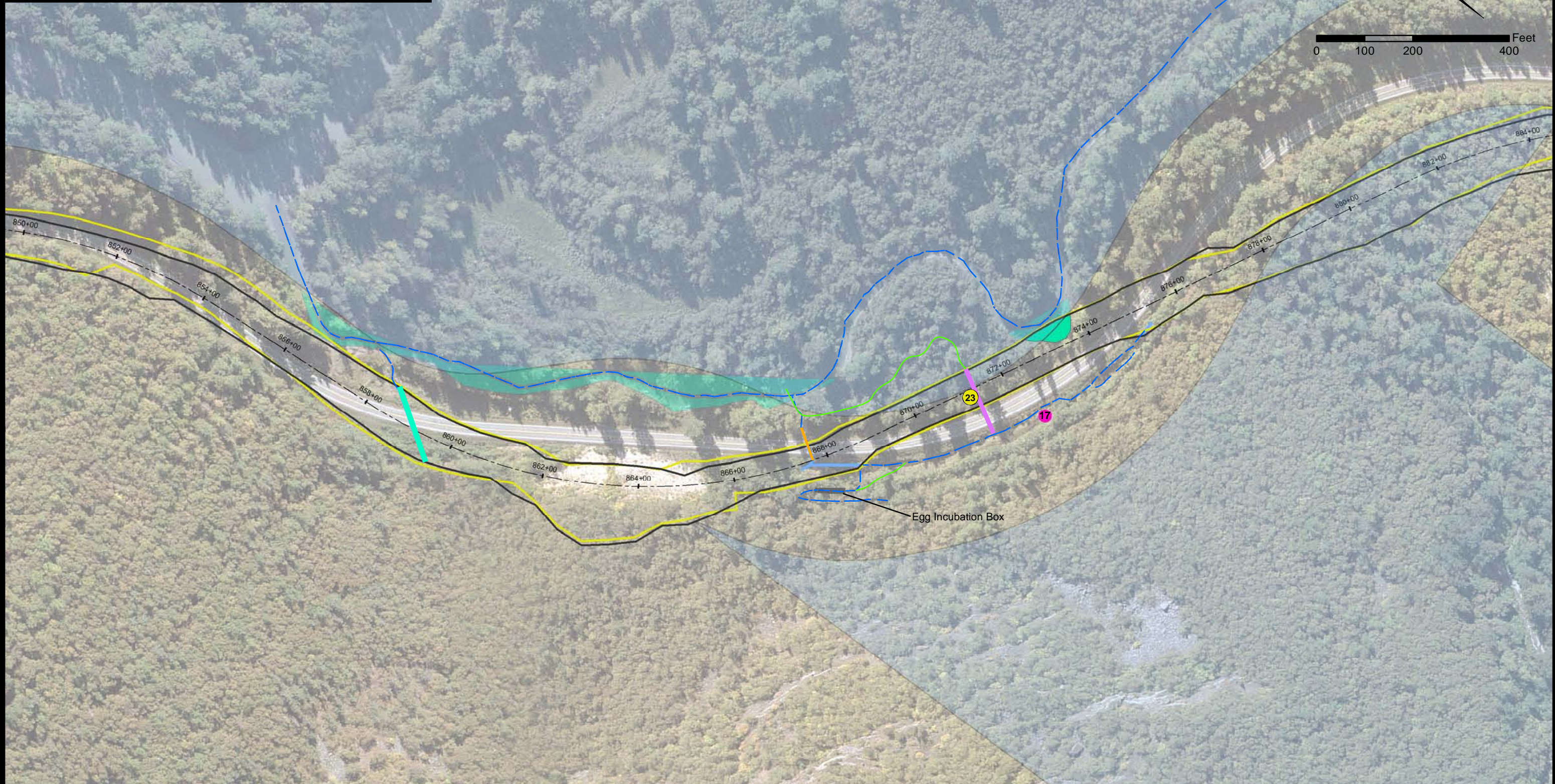
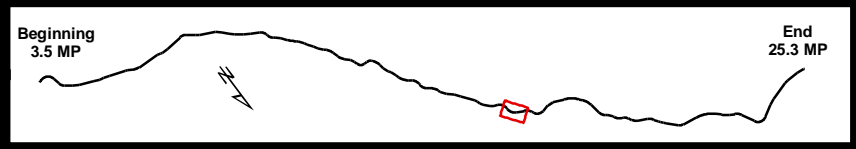

Wetland Type	--- Proposed Centerline	--- Existing Streams	■ Egg Incubation Box
PEM1H	▭ Proposed Cut & Fill Limits	--- Abandoned Culvert	
	▭ Previous EA Cut & Fill Limits	--- Proposed Stream Mitigation	
	● Mile Post Points	--- Upgraded Culvert (non-anadromous streams)	
#	Chilkat River Impacted Polygon ID	--- Upgraded to Fish Passage Culvert	
#	Stream ID Number		

*Darker wetland colors show impacted wetlands. Lighter wetland colors show the extent of wetlands mapped within the 2006 study area. Reference EA acronym list for NWI types.

EFH IMPACTS

TS 28/29/30 S, R 56/57/58/59 E,
Copper River Meridian, Alaska



STATE OF ALASKA
DEPARTMENT OF TRANSPORTATION
AND PUBLIC FACILITIES
DOT & PF Project No. 68606
HAINES HIGHWAY
MILEPOST 3.5 - 25.3
Haines, Alaska

DATE: November 17, 2014 Figure Set 1 (21 OF 34)

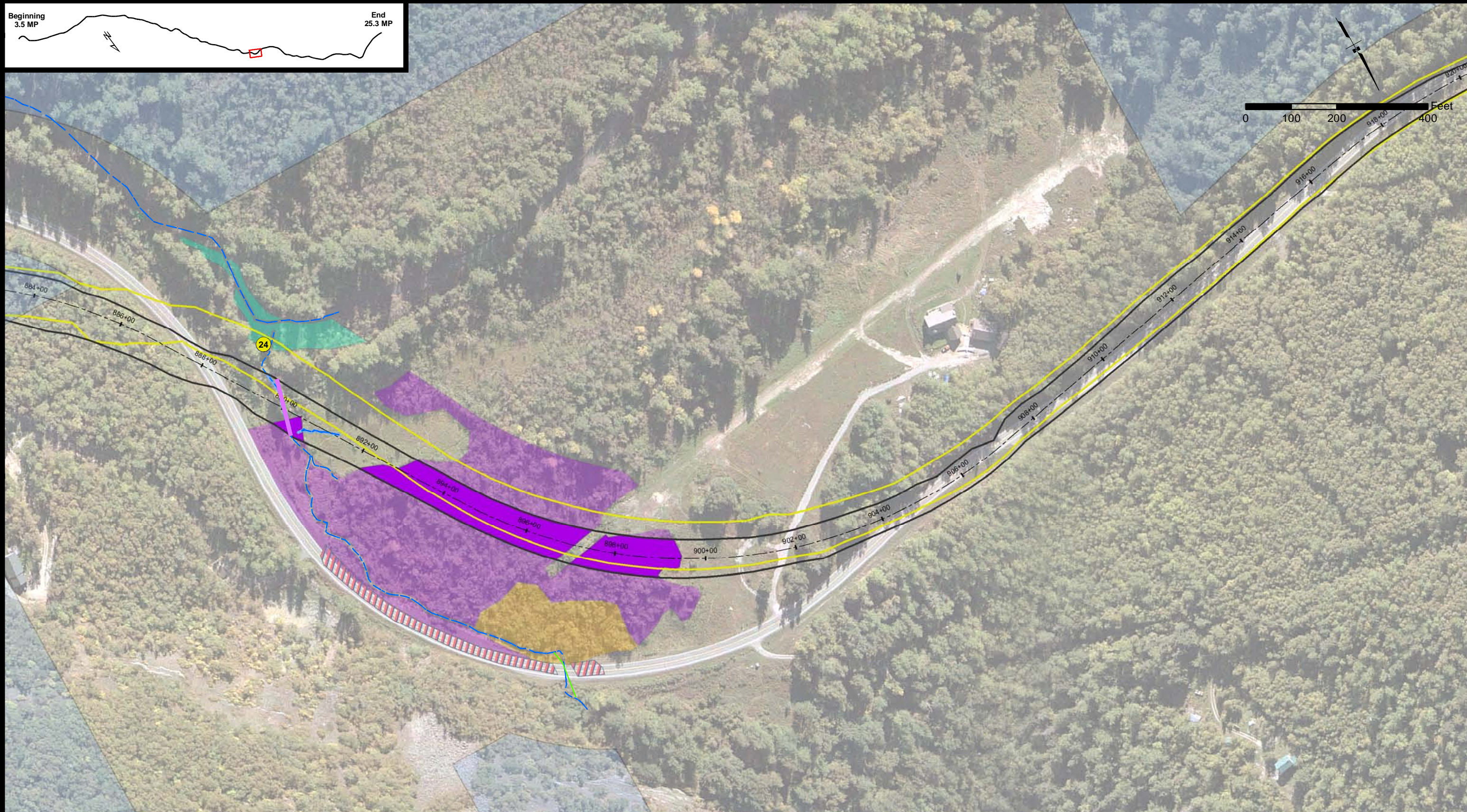
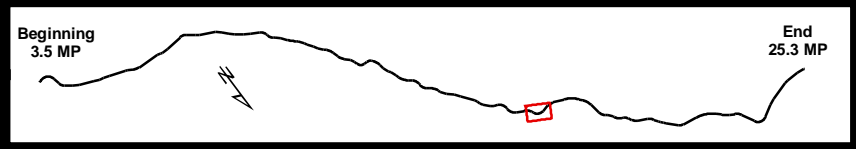

- | | | | |
|---------------------|-------------------------------------|--------------------------------|------------------|
| Wetland Type | --- Proposed Centerline | --- Existing Streams | ▨ Cut (Enhanced) |
| PEM1H | ▭ Proposed Cut & Fill Limits | --- Proposed Stream Mitigation | |
| PSS1E | ▭ Previous EA Cut & Fill Limits | --- Upgraded to | |
| PSS1H | ● Mile Post Points | --- Fish Passage Culvert | |
| | ⊘ Chilkat River Impacted Polygon ID | | |
| | ⊘ Stream ID Number | | |

*Darker wetland colors show impacted wetlands. Lighter wetland colors show the extent of wetlands mapped within the 2006 study area. Reference EA acronym list for NWI types.

EFH IMPACTS

TS 28/29/30 S, R 56/57/58/59 E,
Copper River Meridian, Alaska



STATE OF ALASKA
DEPARTMENT OF TRANSPORTATION
AND PUBLIC FACILITIES
DOT & PF Project No. 68606
HAINES HIGHWAY
MILEPOST 3.5 - 25.3

Haines, Alaska

DATE: November 17, 2014

Figure Set 1 (22 OF 34)

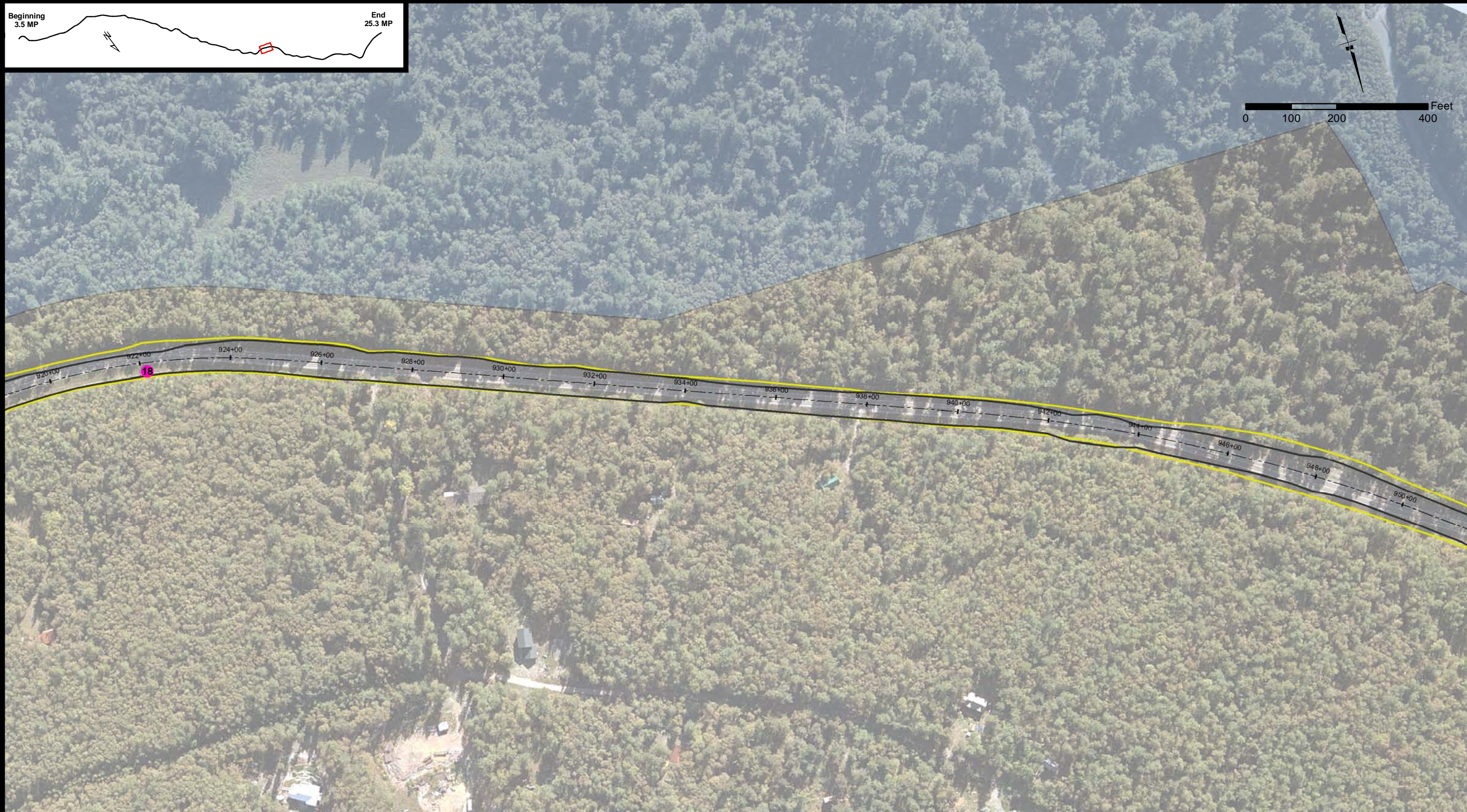
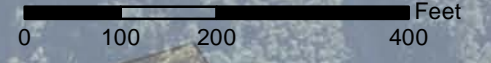
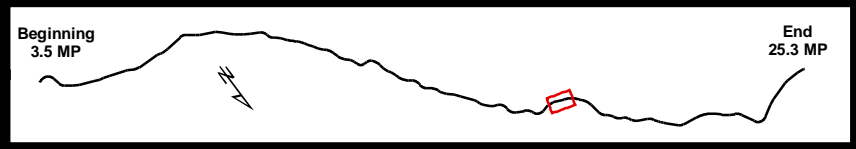

- Proposed Centerline - - - Existing Streams
- ▭ Proposed Cut & Fill Limits
- ▭ Previous EA Cut & Fill Limits
- Mile Post Points
- # Chilkat River Impacted Polygon ID
- # Stream ID Number

*Darker wetland colors show impacted wetlands. Lighter wetland colors show the extent of wetlands mapped within the 2006 study area. Reference EA acronym list for NWI types.

EFH IMPACTS

TS 28/29/30 S, R 56/57/58/59 E,
Copper River Meridian, Alaska



STATE OF ALASKA
DEPARTMENT OF TRANSPORTATION
AND PUBLIC FACILITIES
DOT & PF Project No. 68606
HAINES HIGHWAY
MILEPOST 3.5 - 25.3

Haines, Alaska

DATE: November 17, 2014

Figure Set 1 (23 OF 34)

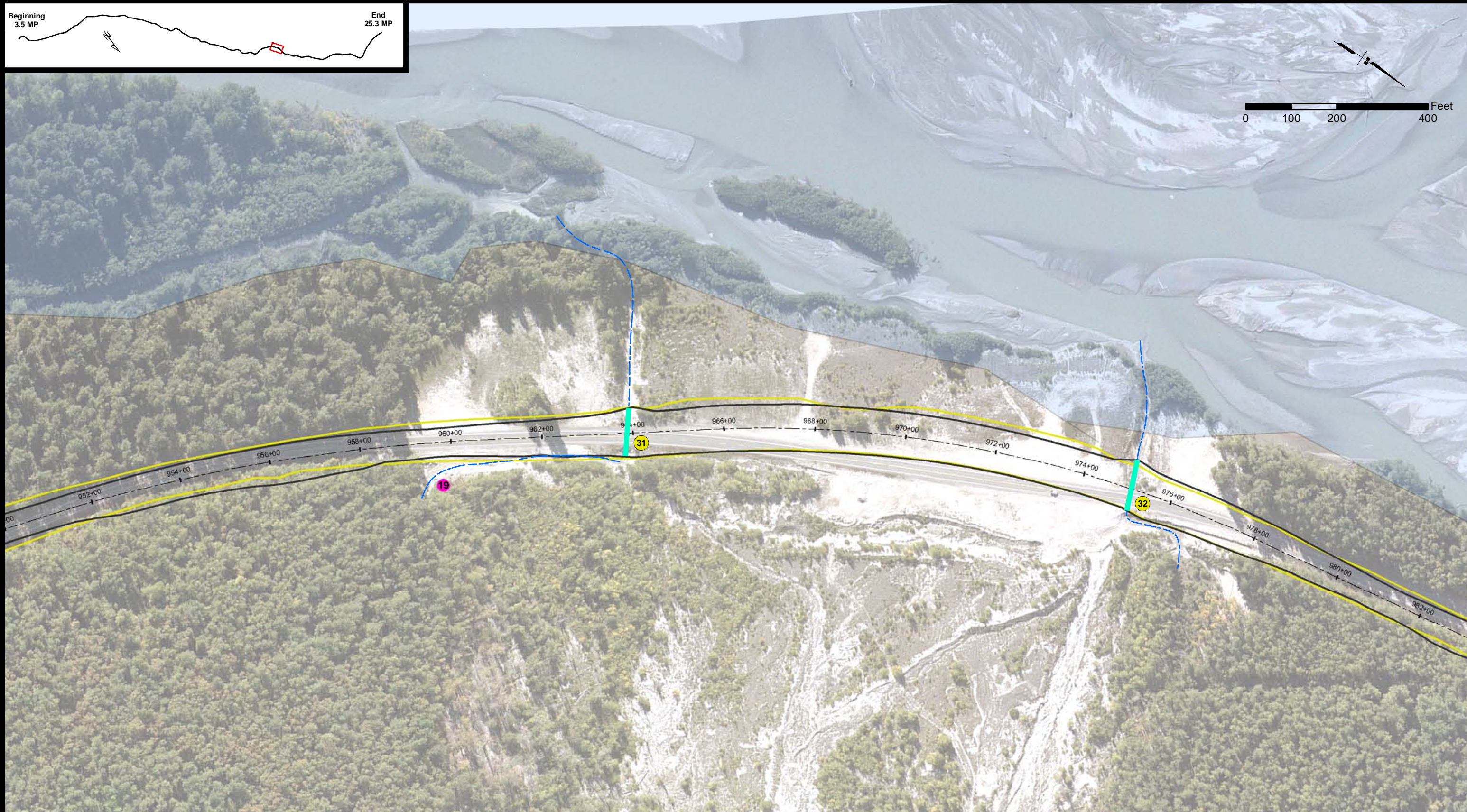
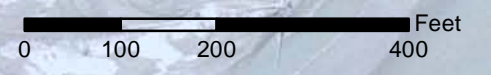
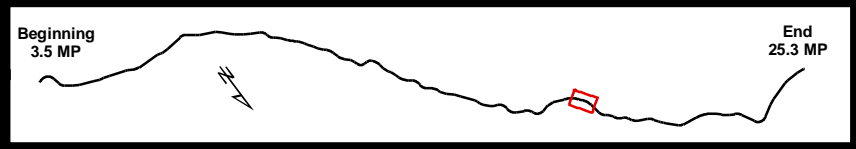

- Proposed Centerline
- Existing Streams
- ▭ Proposed Cut & Fill Limits
- ▭ Upgraded Culvert (non-anadromous streams)
- ▭ Previous EA Cut & Fill Limits
- Mile Post Points
- ⊘ Chilkat River Impacted Polygon ID
- ⊘ Stream ID Number

*Darker wetland colors show impacted wetlands. Lighter wetland colors show the extent of wetlands mapped within the 2006 study area. Reference EA acronym list for NWI types.

EFH IMPACTS

TS 28/29/30 S, R 56/57/58/59 E,
Copper River Meridian, Alaska



STATE OF ALASKA
DEPARTMENT OF TRANSPORTATION
AND PUBLIC FACILITIES
DOT & PF Project No. 68606
HAINES HIGHWAY
MILEPOST 3.5 - 25.3

Haines, Alaska

DATE: November 17, 2014

Figure Set 1 (24 OF 34)

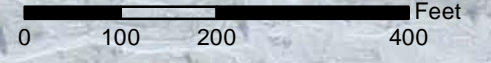
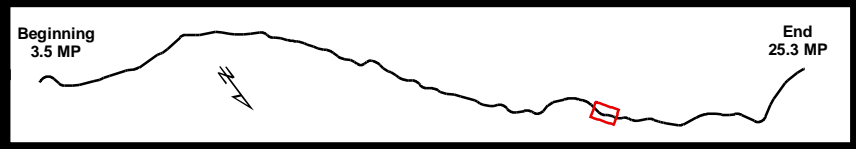

Wetland Type	--- Proposed Centerline	--- Existing Streams
PEM1H	▭ Proposed Cut & Fill Limits	--- Upgraded Culvert (non-anadromous streams)
R3OW	▭ Previous EA Cut & Fill Limits	
	● Mile Post Points	
	# Chilkat River Impacted Polygon ID	
	# Stream ID Number	

*Darker wetland colors show impacted wetlands. Lighter wetland colors show the extent of wetlands mapped within the 2006 study area. Reference EA acronym list for NWI types.

EFH IMPACTS

TS 28/29/30 S, R 56/57/58/59 E,
Copper River Meridian, Alaska



STATE OF ALASKA
DEPARTMENT OF TRANSPORTATION
AND PUBLIC FACILITIES
DOT & PF Project No. 68606
HAINES HIGHWAY
MILEPOST 3.5 - 25.3
Haines, Alaska

DATE: November 17, 2014 Figure Set 1 (25 OF 34)

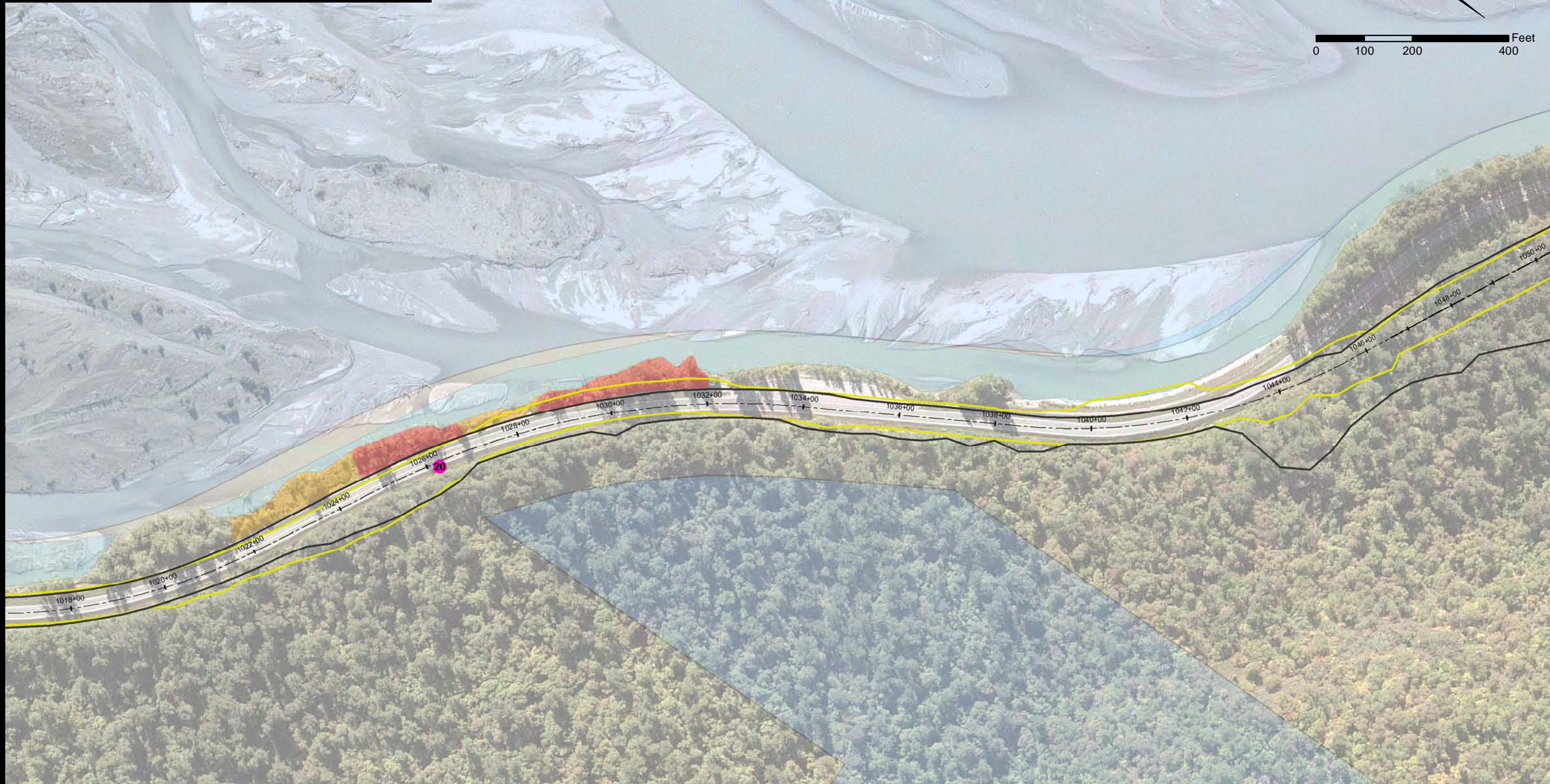
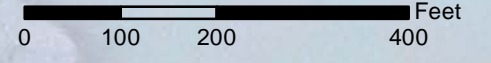
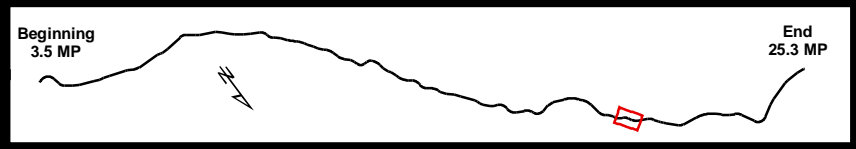

- | | | |
|---|---|----------------------|
| Wetland Type | --- Proposed Centerline | --- Existing Streams |
| PFO1C | Proposed Cut & Fill Limits | |
| PSS1H | Previous EA Cut & Fill Limits | |
| R3OW | ● Mile Post Points | |
| | ⊘ Chilkat River Impacted Polygon ID | |
| | ⊘ Stream ID Number | |

**Darker wetland colors show impacted wetlands. Lighter wetland colors show the extent of wetlands mapped within the 2006 study area. Reference EA acronym list for NWI types.*

EFH IMPACTS

TS 28/29/30 S, R 56/57/58/59 E,
Copper River Meridian, Alaska



STATE OF ALASKA
DEPARTMENT OF TRANSPORTATION
AND PUBLIC FACILITIES
DOT & PF Project No. 68606
HAINES HIGHWAY
MILEPOST 3.5 - 25.3

Haines, Alaska

DATE: November 17, 2014

Figure Set 1 (26 OF 34)

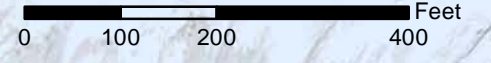
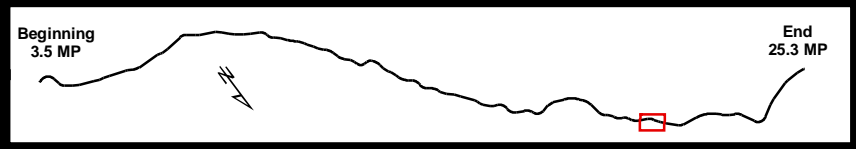

- Wetland Type
- R3OW
- Proposed Centerline
- Proposed Cut & Fill Limits
- Previous EA Cut & Fill Limits
- Mile Post Points
- Chilkat River Impacted Polygon ID
- Stream ID Number
- Existing Streams

*Darker wetland colors show impacted wetlands. Lighter wetland colors show the extent of wetlands mapped within the 2006 study area. Reference EA acronym list for NWI types.

EFH IMPACTS

TS 28/29/30 S, R 56/57/58/59 E,
Copper River Meridian, Alaska



STATE OF ALASKA
DEPARTMENT OF TRANSPORTATION
AND PUBLIC FACILITIES
DOT & PF Project No. 68606
HAINES HIGHWAY
MILEPOST 3.5 - 25.3

Haines, Alaska

DATE: November 17, 2014

Figure Set 1 (27 OF 34)

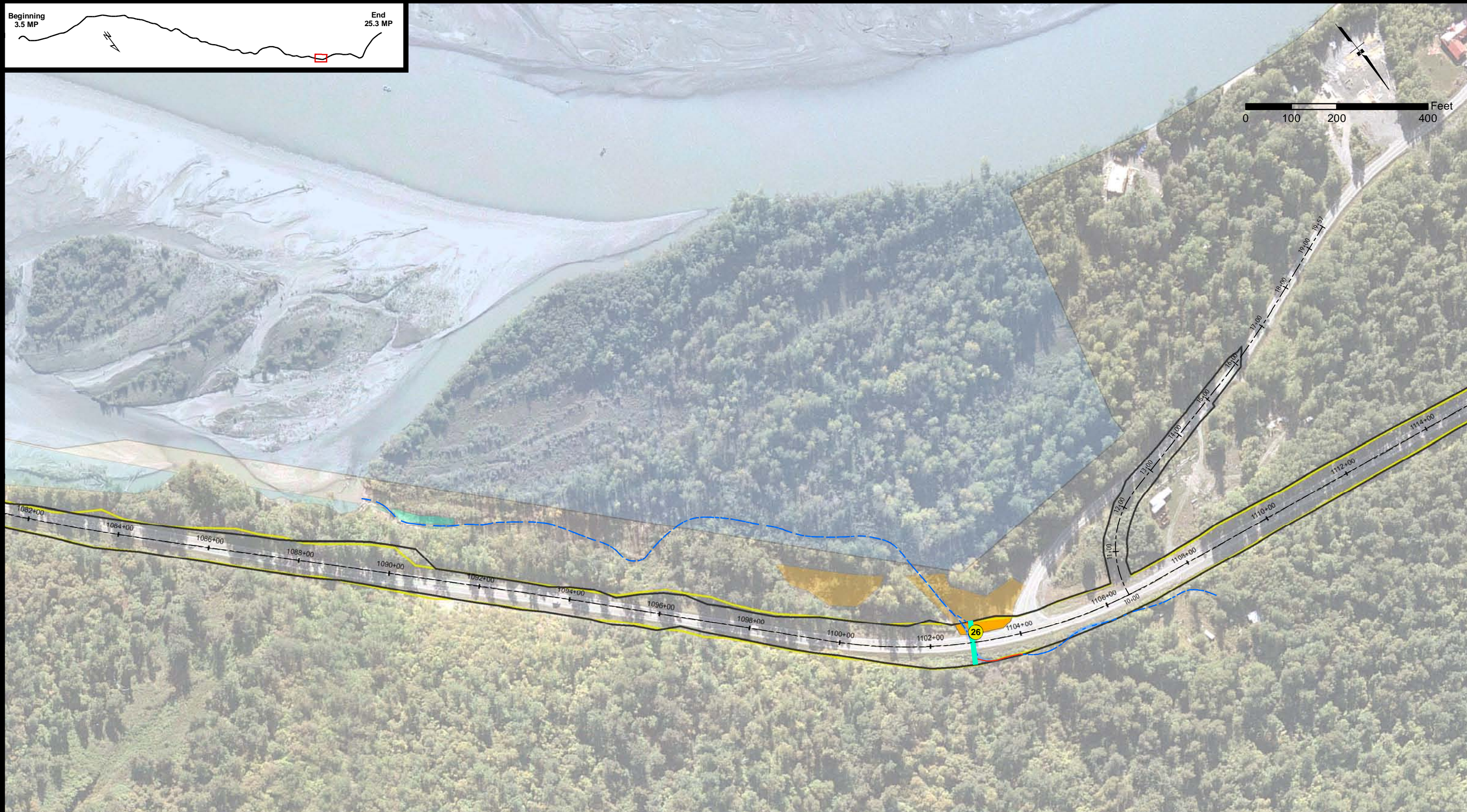
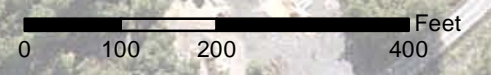
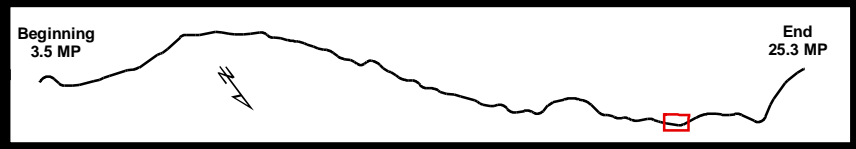

Wetland Type	--- Proposed Centerline	--- Existing Streams
PEM1H	▭ Proposed Cut & Fill Limits	--- Stream Impacts
PSS1H	▭ Previous EA Cut & Fill Limits	--- Upgraded Culvert (non-anadromous streams)
R3OW	● Mile Post Points	
	⊘ Chilkat River Impacted Polygon ID	
	⊘ Stream ID Number	

*Darker wetland colors show impacted wetlands. Lighter wetland colors show the extent of wetlands mapped within the 2006 study area. Reference EA acronym list for NWI types.

EFH IMPACTS

TS 28/29/30 S, R 56/57/58/59 E,
Copper River Meridian, Alaska



STATE OF ALASKA
DEPARTMENT OF TRANSPORTATION
AND PUBLIC FACILITIES
DOT & PF Project No. 68606
HAINES HIGHWAY
MILEPOST 3.5 - 25.3
Haines, Alaska

DATE: November 17, 2014 Figure Set 1 (28 OF 34)

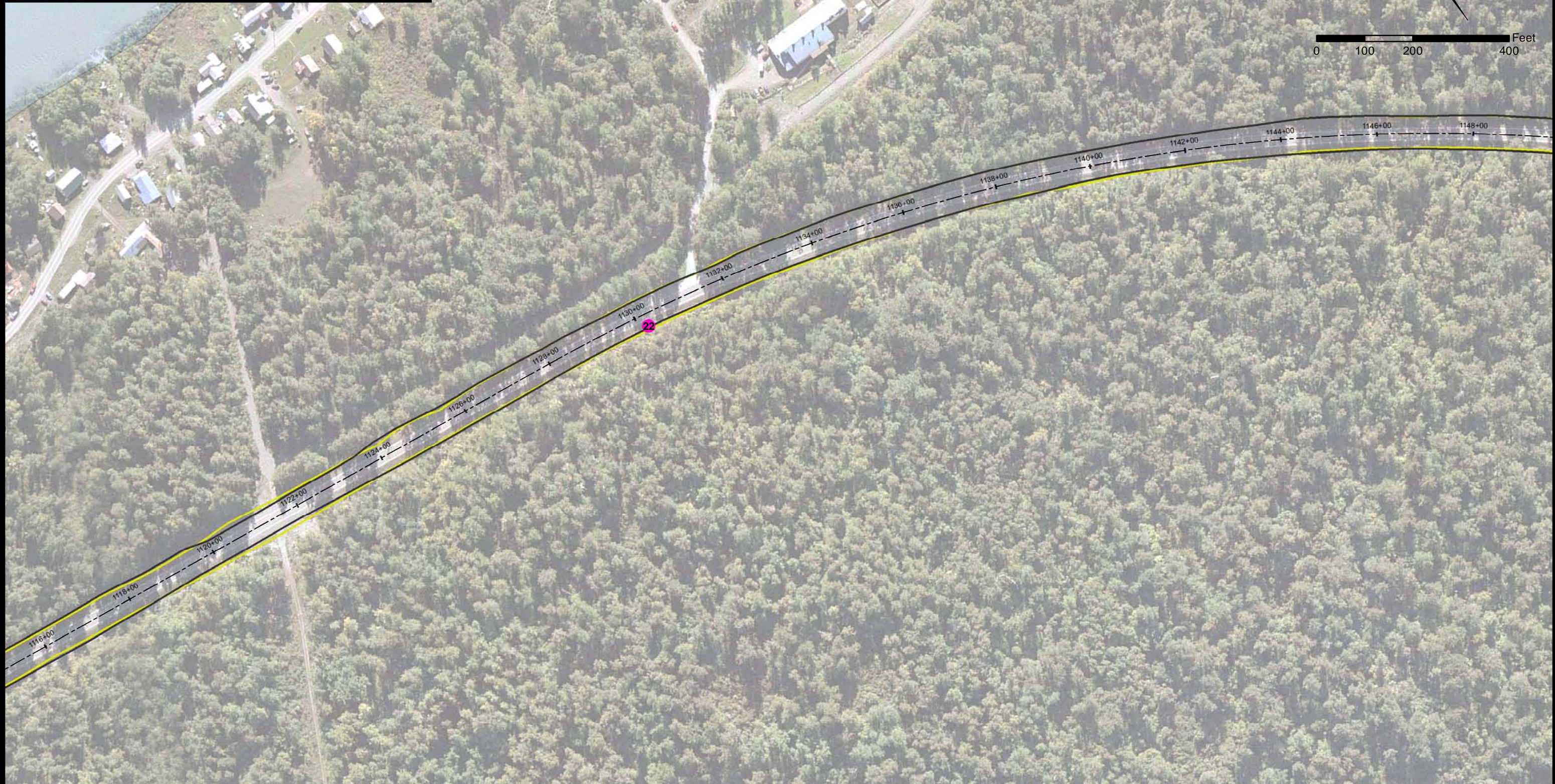
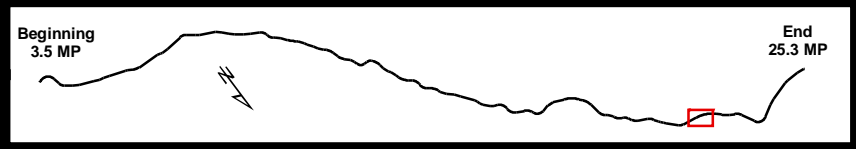

- - - Proposed Centerline - - - Existing Streams
 [Black outline] Proposed Cut & Fill Limits
 [Yellow outline] Previous EA Cut & Fill Limits
 ● Mile Post Points
 # Chilkat River Impacted Polygon ID
 # Stream ID Number
*Darker wetland colors show impacted wetlands. Lighter wetland colors show the extent of wetlands mapped within the 2006 study area. Reference EA acronym list for NWI types.

EFH IMPACTS

TS 28/29/30 S, R 56/57/58/59 E,
Copper River Meridian, Alaska



STATE OF ALASKA
 DEPARTMENT OF TRANSPORTATION
 AND PUBLIC FACILITIES
 DOT & PF Project No. 68606
 HAINES HIGHWAY
 MILEPOST 3.5 - 25.3
 Haines, Alaska

DATE: November 17, 2014 Figure Set 1 (29 OF 34)

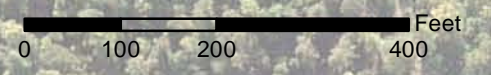
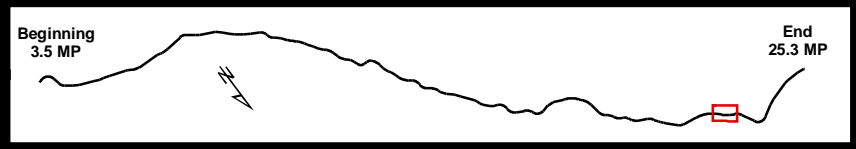

Wetland Type	--- Proposed Centerline	--- Existing Streams
■ R3OW	▭ Proposed Cut & Fill Limits	▭ Upgraded Culvert (non-anadromous streams)
	▭ Previous EA Cut & Fill Limits	
● Mile Post Points		
# Chilkat River Impacted Polygon ID		
# Stream ID Number		

*Darker wetland colors show impacted wetlands. Lighter wetland colors show the extent of wetlands mapped within the 2006 study area. Reference EA acronym list for NWI types.

EFH IMPACTS

TS 28/29/30 S, R 56/57/58/59 E,
Copper River Meridian, Alaska



STATE OF ALASKA
DEPARTMENT OF TRANSPORTATION
AND PUBLIC FACILITIES
DOT & PF Project No. 68606
HAINES HIGHWAY
MILEPOST 3.5 - 25.3
Haines, Alaska

DATE: November 17, 2014 Figure Set 1 (30 OF 34)

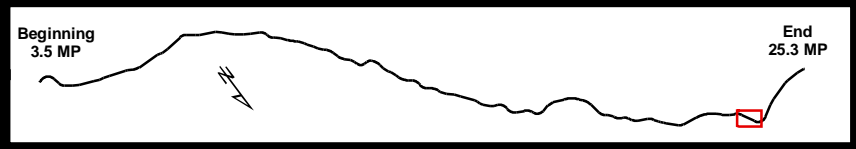

Wetland Type	--- Proposed Centerline	--- Existing Streams
R3OW	Proposed Cut & Fill Limits	Upgraded Culvert (non-anadromous streams)
	Previous EA Cut & Fill Limits	
	● Mile Post Points	
	⊕ Chilkat River Impacted Polygon ID	
	⊙ Stream ID Number	

*Darker wetland colors show impacted wetlands. Lighter wetland colors show the extent of wetlands mapped within the 2006 study area. Reference EA acronym list for NWI types.

EFH IMPACTS

TS 28/29/30 S, R 56/57/58/59 E,
Copper River Meridian, Alaska



STATE OF ALASKA
DEPARTMENT OF TRANSPORTATION
AND PUBLIC FACILITIES
DOT & PF Project No. 68606
HAINES HIGHWAY
MILEPOST 3.5 - 25.3
Haines, Alaska

DATE: November 17, 2014 Figure Set 1 (31 OF 34)

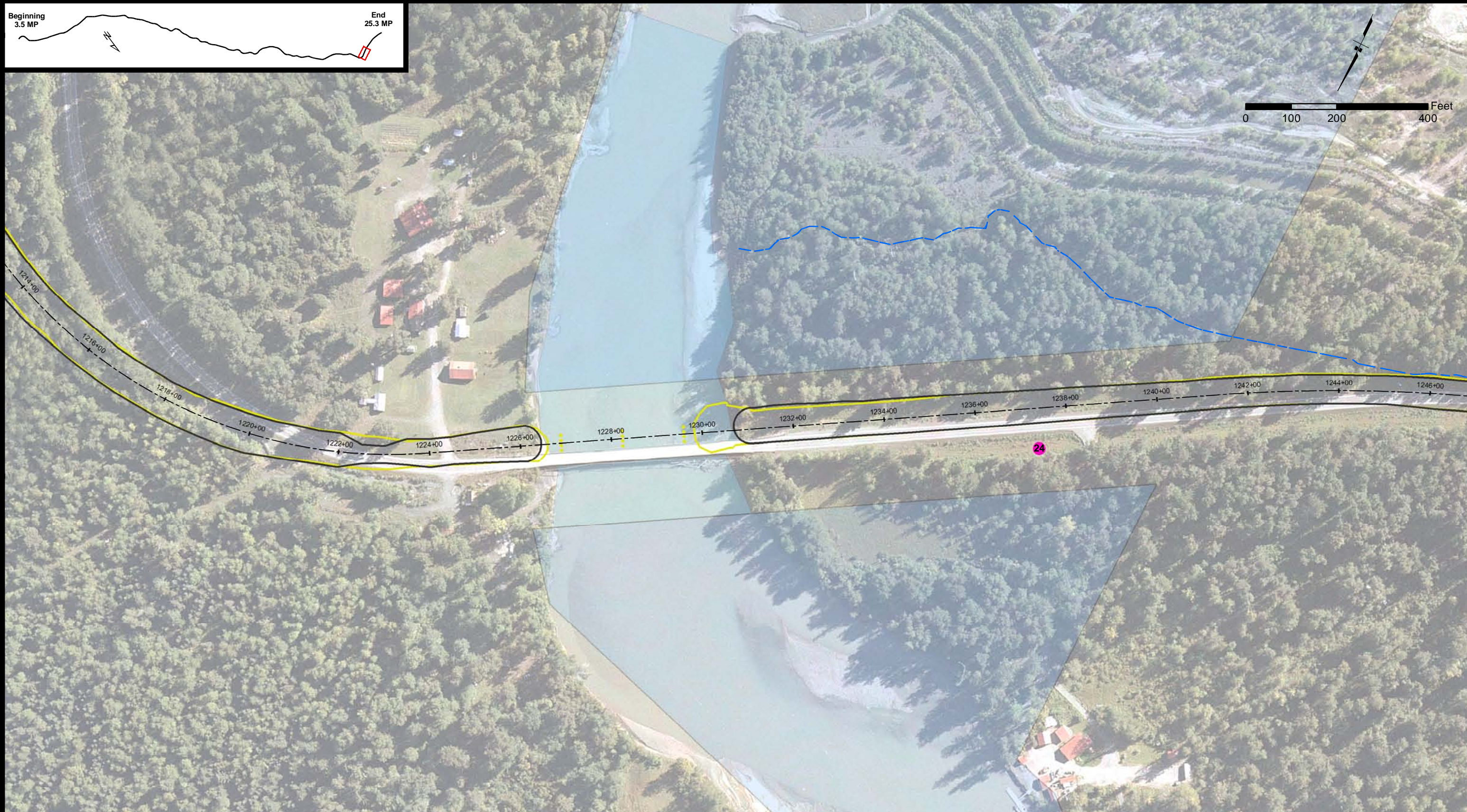
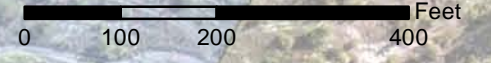
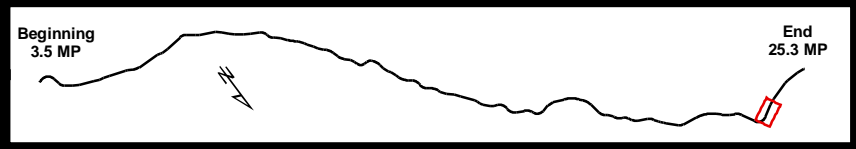

- Wetland Type
- R3OW
- Proposed Centerline
- Proposed Cut & Fill Limits
- Previous EA Cut & Fill Limits
- Mile Post Points
- Chilkat River Impacted Polygon ID
- Stream ID Number
- Existing Streams

*Darker wetland colors show impacted wetlands. Lighter wetland colors show the extent of wetlands mapped within the 2006 study area. Reference EA acronym list for NWI types.

EFH IMPACTS

TS 28/29/30 S, R 56/57/58/59 E,
Copper River Meridian, Alaska



STATE OF ALASKA
DEPARTMENT OF TRANSPORTATION
AND PUBLIC FACILITIES
DOT & PF Project No. 68606
HAINES HIGHWAY
MILEPOST 3.5 - 25.3

Haines, Alaska

DATE: November 17, 2014

Figure Set 1 (32 OF 34)

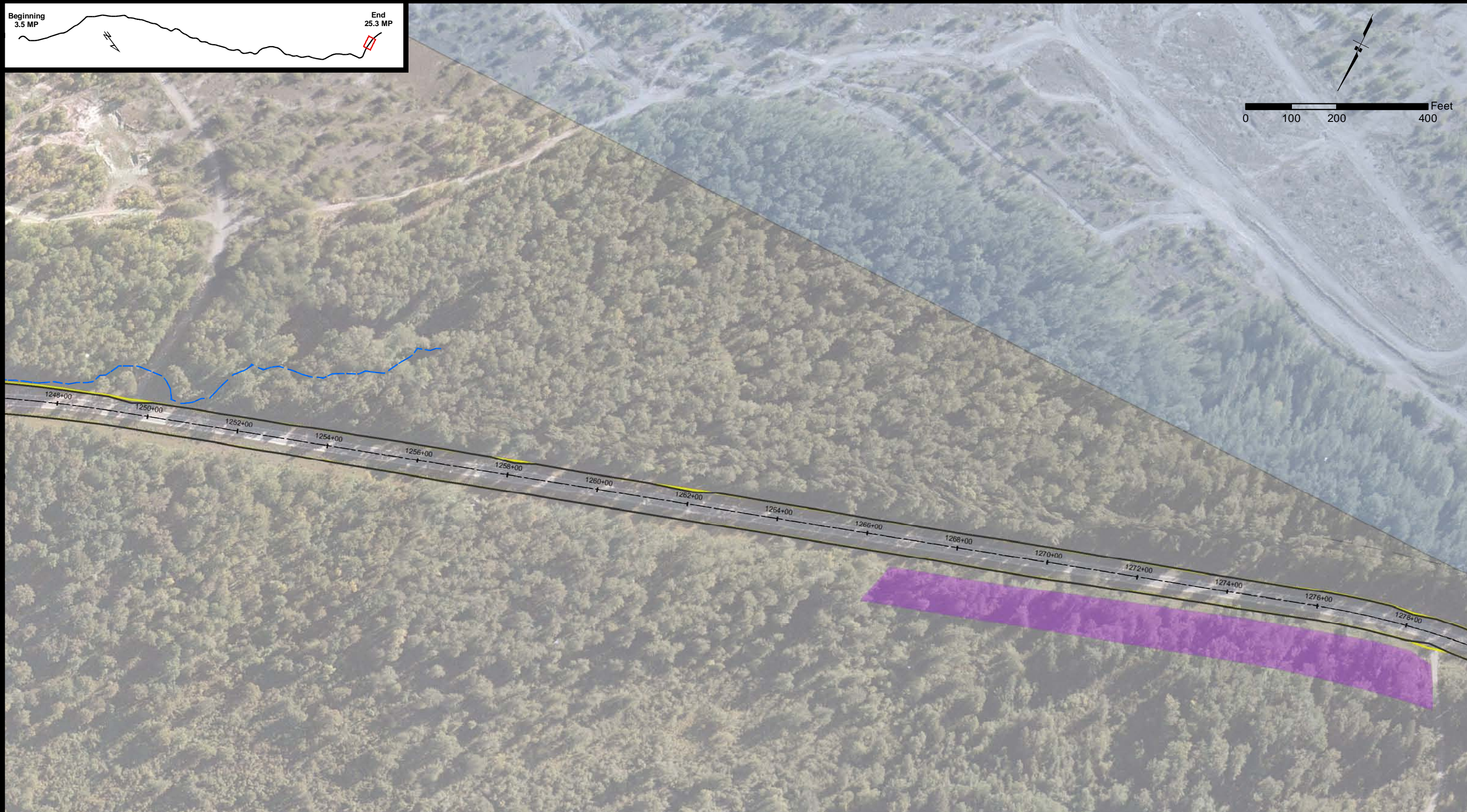
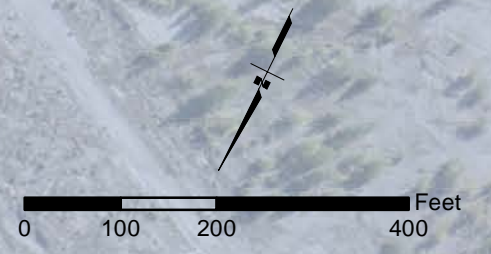
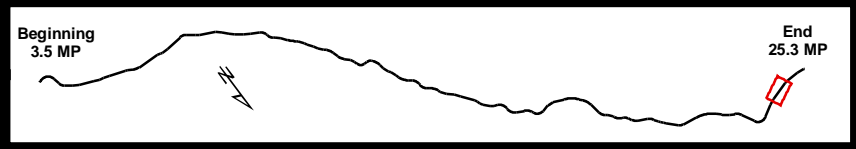

- Wetland Type**
- PSS1E
- Proposed Centerline
- Existing Streams
- Proposed Cut & Fill Limits
- Previous EA Cut & Fill Limits
- Mile Post Points
- # Chilkat River Impacted Polygon ID
- # Stream ID Number

*Darker wetland colors show impacted wetlands. Lighter wetland colors show the extent of wetlands mapped within the 2006 study area. Reference EA acronym list for NWI types.

EFH IMPACTS

TS 28/29/30 S, R 56/57/58/59 E,
Copper River Meridian, Alaska



STATE OF ALASKA
DEPARTMENT OF TRANSPORTATION
AND PUBLIC FACILITIES
DOT & PF Project No. 68606
HAINES HIGHWAY
MILEPOST 3.5 - 25.3

Haines, Alaska

DATE: November 17, 2014

Figure Set 1 (33 OF 34)

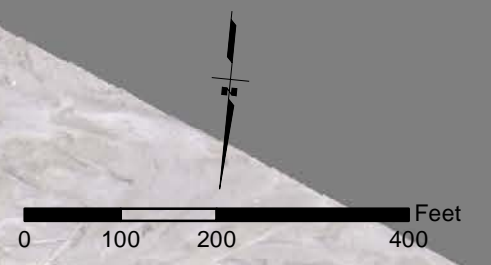
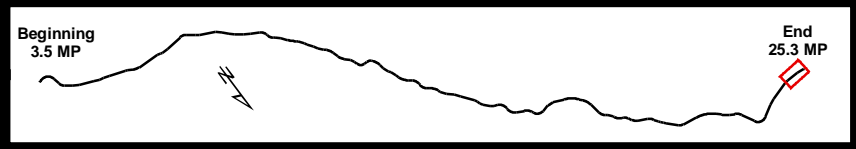

- | | | |
|---------------------|-----------------------------------|----------------------|
| Wetland Type | --- Proposed Centerline | --- Existing Streams |
| PSS1E | Proposed Cut & Fill Limits | |
| R3OW | Previous EA Cut & Fill Limits | |
| | Mile Post Points | |
| | Chilkat River Impacted Polygon ID | |
| | Stream ID Number | |

*Darker wetland colors show impacted wetlands. Lighter wetland colors show the extent of wetlands mapped within the 2006 study area. Reference EA acronym list for NWI types.

EFH IMPACTS

TS 28/29/30 S, R 56/57/58/59 E,
Copper River Meridian, Alaska



STATE OF ALASKA
DEPARTMENT OF TRANSPORTATION
AND PUBLIC FACILITIES
DOT & PF Project No. 68606
HAINES HIGHWAY
MILEPOST 3.5 - 25.3

Haines, Alaska

DATE: November 17, 2014

Figure Set 1 (34 OF 34)

Table A-1 CHILKAT RIVER IMPACTS

Sheet Number	Polygon ID	Beginning Station	End Station	Nearest MP	Square Ft	Linear Ft	Avoidance	Minimization	Justification
1	1	195+50	197+50	4	10,480	302		Added guardrail to reduce impact by 550 sf/125 lf	Shifting alignment north would require rock cuts and would disturb a sensitive cultural resource.
3	2	263+00	265+00	5	707	169		Added guardrail to reduce impact by 215 sf/33 lf	Shifting alignment north would require realignment from station 242+00 to station 268+00 and result in larger impact to high-value emergent wetlands (6,500 sf) than river area impacted.
3	3	274+25	274+75	5	4	11	Added guardrail to reduce impacts by 25 sf/ 40 lf		
3-4	4	284+50	289+00	5	3,059	404		Added guardrail to reduce impact by 1,300 sf/ 260 lf	Would require significant rock excavation on private property. Would require realignment from station 286+00 to station 310+00 and would require acquisition of private land.
4	5	297+00	302+00	6	3,562	452		Added guardrail to reduce impact by 380 sf/ no reduction in lf	Would require significant rock excavation on private property. Would require realignment from station 286+00 to station 310+00 and would require acquisition of private land.
4	NA	302+00	311+00	6			Shifted alignment north to avoid impact.		
4	6	311+00	314+00		1,168	165		Added guardrail to reduce impact by 240 sf/ 50 lf	Shifting alignment north would require acquisition of private land.
5	7	336+70	337+25	7	134	60		Added guardrail to reduce impact by 37 sf/ 45 lf	
5	8	337+60	338+25	7	100	60		Added guardrail to reduce impact by 32 sf/ 45 lf	
6	9	350+00	358+00	7	10,292	771		Added guardrail to reduce impact by 2,890 sf/ 370 lf	Would require substantial realignment from station 326+00 to station 360+00.
6	NA	360+50	363+00				Alignment shifted north to avoid river. Impacts reduced by 262 sf/ 116 lf.		
6	10	364+00	368+00	8	113	57		Reduced curve radius and adjusted tangent to reduce impact by 6,525 sf/ 392 lf	Curve is at the minimum allowable length and radius for design criteria.
6	11	370+00	376+50	8	4,952	485		Added guardrail to reduce impact by 1,050 sf/9 lf and shifted alignment north to reduce impact another 4,565 sf/ 60 lf	Shifting alignment north would impact tributary stream and require substantial rock excavation including developed private residential properties. Would require realignment from station 356+00 to station 402+00 and would require acquisition of private land.
6-7	12	379+50	385+75	8	2,567	524	Alignment shifted north to avoid river	Added curve to reduce impact by 44,758 sf/ 414 lf	Curve is at the minimum allowable length and radius for design criteria. Polygon 12 includes area for an engineered spur to facilitate bank complexity and encourage habitat.
7	NA	385+75	388+25	8					
7	13	388+25	392+00	8	2,770	332			
7	NA	394+50	395+00	8			Added guardrail to reduce impacts by 76 sf/ 19 lf		
7	NA	395+00	398+50	8			Alignment shifted north to avoid river. Impacts reduced by 9,858 sf/ 905 lf		
7	NA	399+00	399+50	8					
7	NA	399+50	400+50	8					
7	NA	400+75	401+00	8					
7	NA	401+25	405+25	8					

7	14	405+75	406+25	8	89	28		Guardrail added	Alignment moved as far north as possible.
7	15	406+50	410+00	8	2,204	217		Guardrail added	Curve added to facilitate reduction of impacts at station 416+00.
7-8	16	412+00	418+00	8	7,870	547		Added curve to reduce impact by 21,605sf/125 lf	Curve is at the minimum allowable length and radius for design criteria. Polygon 16 includes area for an engineered spur to facilitate bank complexity and encourage habitat.
8	17-18	423+00	426+00	9	905	154		Guardrail added	Added curve to facilitate significant reduction at station 430+00 to 442+00
8	19	427+75	437+00	9	16,772	872		Added curve to reduce impact by 87,316 sf/438 lf	Minimum back to back curves still meet design criteria. Polygon 19 and 20 include areas for engineered spurs to facilitate bank complexity and encourage habitat.
8	20	439+00	448+00	9	24,879	904			
9	21	448+00	452+50	9	4,447	467		Guardrail added	An alternative alignment was considered. It required extensive rock excavation with impacts to an already steep private access road and developed residential properties. It did not meet design standards for curve length and eliminated passing opportunities.
9	22	454+00	458+00	9	3,737	398		Reduced curve radius and adjusted tangent to reduce impact by 5,441 sf/191 lf	Alignment moved as far north as possible.
9	23	459+70	470+00	10	14,184	1,020		Added guardrail and shifted alignment north to reduce impact by 7,500 sf / 80 lf	Alignment moved as far north as possible. Polygon 23 includes area for an engineered spur to facilitate bank complexity and encourage habitat.
9-10	NA	470+50	493+00	10			Alignment shifted north to avoid river		
10	24	493+00	498+00	10	6,228	447		Added curves to reduce impact by 4,586 sf/ 207 lf	Additional curves also reduce impact to high value wetlands between station 486+00 and 492+50. Polygon 24 includes area for an engineered spur to facilitate bank complexity and encourage habitat.
13	25	585+50	588+50	11	1,128	193		Profile lowered to reduce impact by 4,151 sf/118 lf	Alignment moved as far north as possible.
13	NA	590+00	608+50	12			Alignment shifted north to avoid river		
13	26	610+50	614+25	12	1,270	270		Guardrail added	Realignment from station 592+00 to 606+00 reduced impact to high-value wetland, but caused an alignment shift toward the river at station 606+00 to 620+00. Impacts were minimized by lowering the profile.
14	27	620+00	623+00	12	913	221		Lowered profile to reduce impact by 570 sf/165 lf	The alignment matches the existing highway as close as possible.
14	NA	634+75	641+00	13			Added guardrail to avoid 86 sf/ 41 lf		
14	28-29	641+00	642+25	13	108	68		Lowered profile to reduce impact by 1,452 sf/131 lf	The alignment matches the existing highway as close as possible.
15	30	666+50	673+00	13	7,490	626		Lowered profile to reduce impact by 6,595 sf/163 lf	Very challenging area due to topography and existing curves in alignment. Shifting alignment north would increase curve problems instead of reducing them. Would have to realign from stations 660+00 to 690+00 which would increase rock excavation substantially and have greater impacts on emergent wetlands at stations 647+00 to 650+00 and the stream channels between stations 647+00 and 655+00.
15-16	NA	678+00	686+75	13			Alignment shifted north to avoid river. Impacts reduced by 19,081 sf/ 719 lf		
16	31	686+75	693+75	14	3,924	513			
16	32	694+25	695+25	14	368	97		Guardrail Added. Curve addition reduced impact by 8,506 sf/ no reduction in length	
16	33	696+25	699+25	14	3,022	304			Added curve to facilitate significant reduction at station 677+25 to 684+50
16	34	699+75	703+50	14	3,591	383			

17	NA	727+00	735+50	14			Alignment shifted north to avoid river		
17	35	735+50	737+75	14	2,794	214		Added guardrail to reduce impact by 576 sf /14lf	Shifting north would result in steeper curves instead of reducing curves [opposite of P&N] and would have greater stream impacts on north side. Would have to realign from stations 722+00 to 746+00. River bank is already being eroded in this area.
17-18	NA	740+50	759+50	14			Alignment shifted north to avoid river		
18	37	759+75	762+00	15	891	235		Reduced curve radius to reduce impact by 2,697 sf/68 lf	Shifting alignment north would require realignment from stations 750+00 to 782+00 and significant rock cut and impacts on clear water streams to north.
18	NA	762+00	767+25	15			Alignment shifted north to avoid river		
18	38-39	767+50	769+50	15	1,029	192		Adjusted alignment to reduce impact by 5,406 sf/129 lf	Shifting alignment north would require realignment from stations 750+00 to 782+00 and significant rock cut and impacts on clear water streams to north.
18	NA	779+00	780+50	15			Alignment shifted north to avoid river		
19	NA	787+50	792+50	15			Alignment shifted north to avoid river		
20	40	816+00	819+50	16	8,024	350		Lowered profile to reduce impact by 5,317 sf/82 lf	Guardrail needed along this section along river and new riprap needed because of the angle that river comes into the road embankment at station 817+50. Would require road realignment for several miles and excavating very large quantities of rock. Would realign road from stations 802+00 to 836+00. It would also require land acquisition for ROW.
26	NA	1038+50	1058+00	21			Alignment shifted north to avoid river 953 sf / 202 lf		
27-28	NA	1065+00	1084+00	21			Alignment shifted north to avoid river		
32	NA	1226+00	1226+00	24					Bridge abutments need riprap to provide scour protection.
32	NA	1226+25	1229+00	24				Reduced piers in water associated with new bridge	Width of river requires a bridge crossing with four spans and three pair groups in the water.
32	NA	1229+25	1230+25	24					Bridge abutments need riprap to provide scour protection.
					Square Ft	Linear Ft			
TOTAL CHILKAT RIVER IMPACT PER REVISED EA (No avoidance/Minimization Measures)					403,920	18,259			
SUBTRACTED IMPACTS AVOIDED PER REVISED EA					30,341	2,042	Area of no change		
SUBTRACTED IMPACTS MINIMIZED PER REVISED EA					217,804	3,705	Area of increased Impacts		
TOTAL CHILKAT RIVER IMPACT (REVISED EA) (With Alignment Shifts/Guardrails Added)					155,775	12,512	Area of reduced Impacts		

TOTAL CHILKAT RIVER IMPACT PER JULY 2013 EA	335,436 sf	323,008	15,550 lf	14,244
CHILKAT RIVER IMPACTS REDUCED PER REVISED EA	179,661 sf	167,233	3,038 lf	1,732
	4.12 acres	3.84 Acres		

Revisions per DOT&PF, June 25, 2015

APPENDIX B

Stream and Habitat Inventory

State of Alaska Department of Transportation and Public Facilities

Haines Highway - MP 3.5 to MP 25.3 Stream and Habitat Inventory

SHEET INDEX

1	Stream and Habitat Inventory	Vicinity Map and Sheet Index
2	Stream and Habitat Inventory	Plan View: 204+00 to 240+00
3	Stream and Habitat Inventory	Plan View: 240+00 to 270+00
4	Stream and Habitat Inventory	Plan View: 270+00 to 300+00
5	Stream and Habitat Inventory	Plan View: 300+00 to 330+00
6	Stream and Habitat Inventory	Plan View: 330+00 to 360+00
7	Stream and Habitat Inventory	Plan View: 360+00 to 390+00
8	Stream and Habitat Inventory	Plan View: 390+00 to 420+00
9	Stream and Habitat Inventory	Plan View: 420+00 to 450+00
10	Stream and Habitat Inventory	Plan View: 450+00 to 480+00
11	Stream and Habitat Inventory	Plan View: 480+00 to 510+00
12	Stream and Habitat Inventory	Plan View: 510+00 to 540+00
13	Stream and Habitat Inventory	Plan View: 540+00 to 570+00
14	Stream and Habitat Inventory	Plan View: 570+00 to 600+00
15	Stream and Habitat Inventory	Plan View: 600+00 to 628+00
16	Stream and Habitat Inventory	Plan View: 628+00 to 656+00
17	Stream and Habitat Inventory	Plan View: 656+00 to 688+00
18	Stream and Habitat Inventory	Plan View: 688+00 to 720+00
19	Stream and Habitat Inventory	Plan View: 720+00 to 750+00
20	Stream and Habitat Inventory	Plan View: 750+00 to 783+00
21	Stream and Habitat Inventory	Plan View: 783+00 to 813+00
22	Stream and Habitat Inventory	Plan View: 813+00 to 843+00
23	Stream and Habitat Inventory	Plan View: 843+00 to 873+00
24	Stream and Habitat Inventory	Plan View: 873+00 to 905+00
25	Stream and Habitat Inventory	Plan View: 905+00 to 937+00
26	Stream and Habitat Inventory	Plan View: 937+00 to 970+00
27	Stream and Habitat Inventory	Plan View: 970+00 to 1000+00
28	Stream and Habitat Inventory	Plan View: 1000+00 to 1033+00
29	Stream and Habitat Inventory	Plan View: 1033+00 to 1065+00
30	Stream and Habitat Inventory	Plan View: 1065+00 to 1095+00
31	Stream and Habitat Inventory	Plan View: 1095+00 to 1125+00
32	Stream and Habitat Inventory	Plan View: 1125+00 to 1155+00
33	Stream and Habitat Inventory	Plan View: 1155+00 to 1185+00
34	Stream and Habitat Inventory	Plan View: 1185+00 to 1212+00
35	Stream and Habitat Inventory	Plan View: 1212+00 to 1242+00
36	Stream and Habitat Inventory	Plan View: 1238+00 to 1276+00



Note:
The bank type areas delineated on these plan sheets represent the areas of the Chilkat River bank that will be impacted by the proposed alignment change and widening of the Haines Highway. These areas may change if the highway alignment is altered. The vegetation types of the various bank types were determined by field inspection.

Alignment provided by DOWL Engineers 06/14/06.

LEGEND

- 205+00
- PROPOSED ALIGNMNET CENTERLINE
- PROPOSED ALIGNMENT SLOPE LIMITS

HAINES_BASE_SET.dwg

NO.	BY	DATE	REVISION	DESCRIPTION

RP DRAWN	DM,GK,MS DESIGNED	DM,GK,MS CHECKED
DM,GK,MS APPROVED	06/30/06 DATE	PROJECT

State of Alaska Department of Transportation
and Public Facilities – Haines, Alaska
Haines Highway – MP 3.5 to 25.3

Prepared By:
Inter-Fluve, Inc.

1020 Wasco Street, Suite 1
Hood River, OR 97031
541.386.9003
www.interfluve.com

Stream and Habitat Inventory
Vicinity Map and Sheet Index

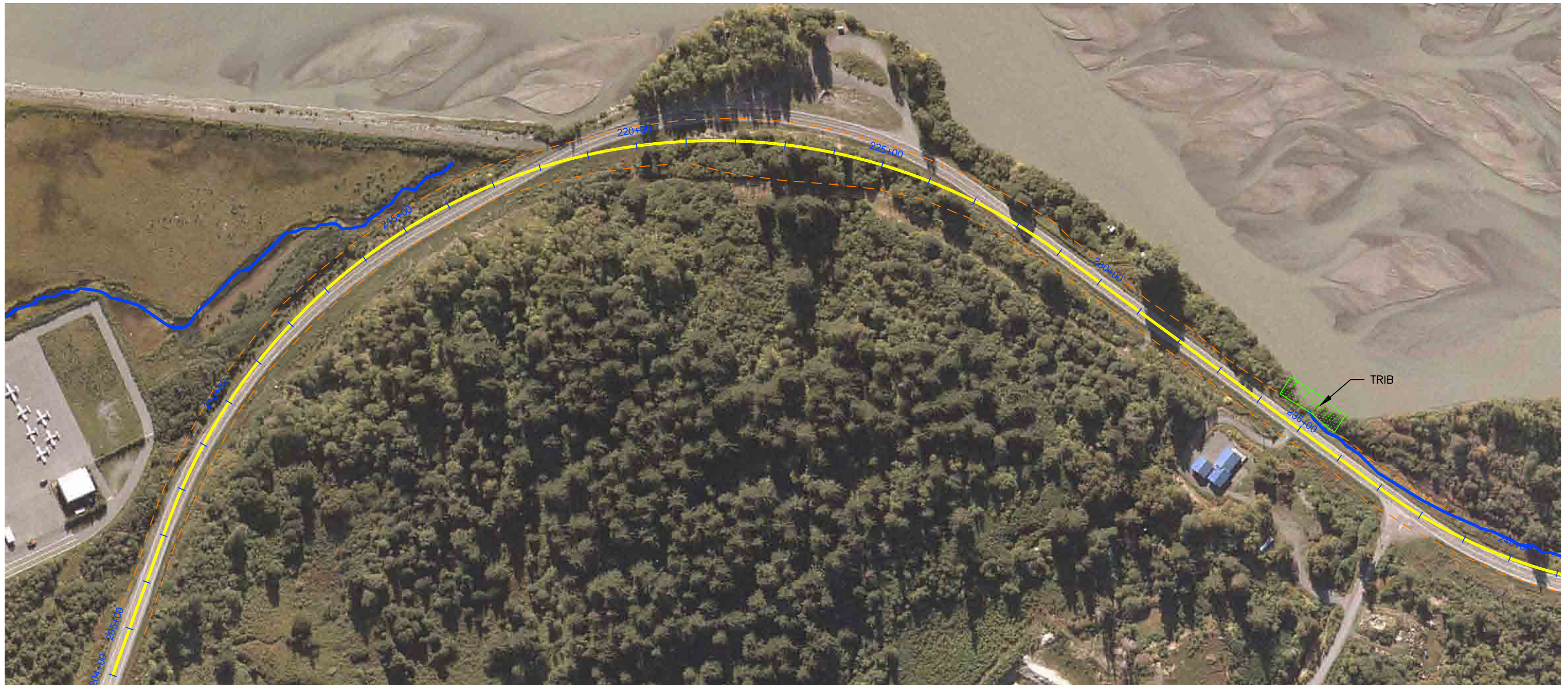

GENERAL NOTES:

THE INITIAL STREAM SURVEY WAS CONDUCTED BETWEEN 10/4/05 AND 10/9/05, AND WAS UPDATED IN MAY AND JUNE 2006. THE STREAMS ARE ORGANIZED BY THE STATIONING OF THE HIGHWAY CROSSING CULVERT. WHERE POSSIBLE, THE STREAM HAS BEEN IDENTIFIED BY ITS ALASKA DEPARTMENT OF FISH AND GAME ANADROMOUS WATERS CATALOG (AWC) NUMBER. LISTED FISH USE INCORPORATES FIELD OBSERVATION, MAY 2006 TRAPPING RESULTS BY OHMP, AND AWC NOTES.

ALL AREAS OF THE CHILKAT RIVER ADJACENT TO THE HIGHWAY LIKELY SERVE AS MIGRATION AND REARING HABITAT FOR ALL FIVE SPECIES OF PACIFIC SALMON AS WELL AS DOLLY VARDEN, CUTTHROAT AND STEELHEAD. HABITAT FUNCTIONS NOTED ON THIS SHEET ARE IN ADDITION TO THESE USES.

TRIB STATION 210+50 TO 216+50

CATALOG NUMBER: 115-32-10250-2002-3017
 FISH USE: REARING COHO
 DESCRIPTION: THIS STREAM RUNS ADJACENT TO THE HIGHWAY AND WILL NOT BE IMPACTED BY THE PROPOSED REALIGNMENT AND WIDENING OF THE HAINES HIGHWAY. THE STREAM IS LOCATED FOR INFORMATION PURPOSES. IT WAS NOT SURVEYED.

**BANK STATION 234+25 TO 235+50:
 EULACHON SPAWNING**

TRIB STATION 245+50
 SEE SHEET 3

LEGEND

 MIDMATURITY-FORESTED

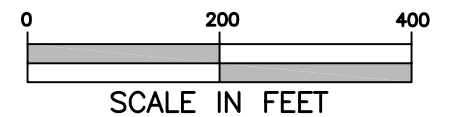

HAINES_BASE_SET.dwg

NO.	BY	DATE	REVISION	DESCRIPTION

RP	DM,GK,MS	DM,GK,MS
DRAWN	DESIGNED	CHECKED
DM,GK,MS	06/30/06	
APPROVED	DATE	PROJECT

State of Alaska Department of Transportation
 and Public Facilities – Haines, Alaska
 Haines Highway – MP 3.5 to 25.3

Prepared By:
 Inter-Fluve, Inc.
 1020 Wasco Street, Suite 1
 Hood River, OR 97031
 541.386.9003
 www.interfluve.com

Stream and Habitat Inventory
 Plan View: 204+00 to 240+00

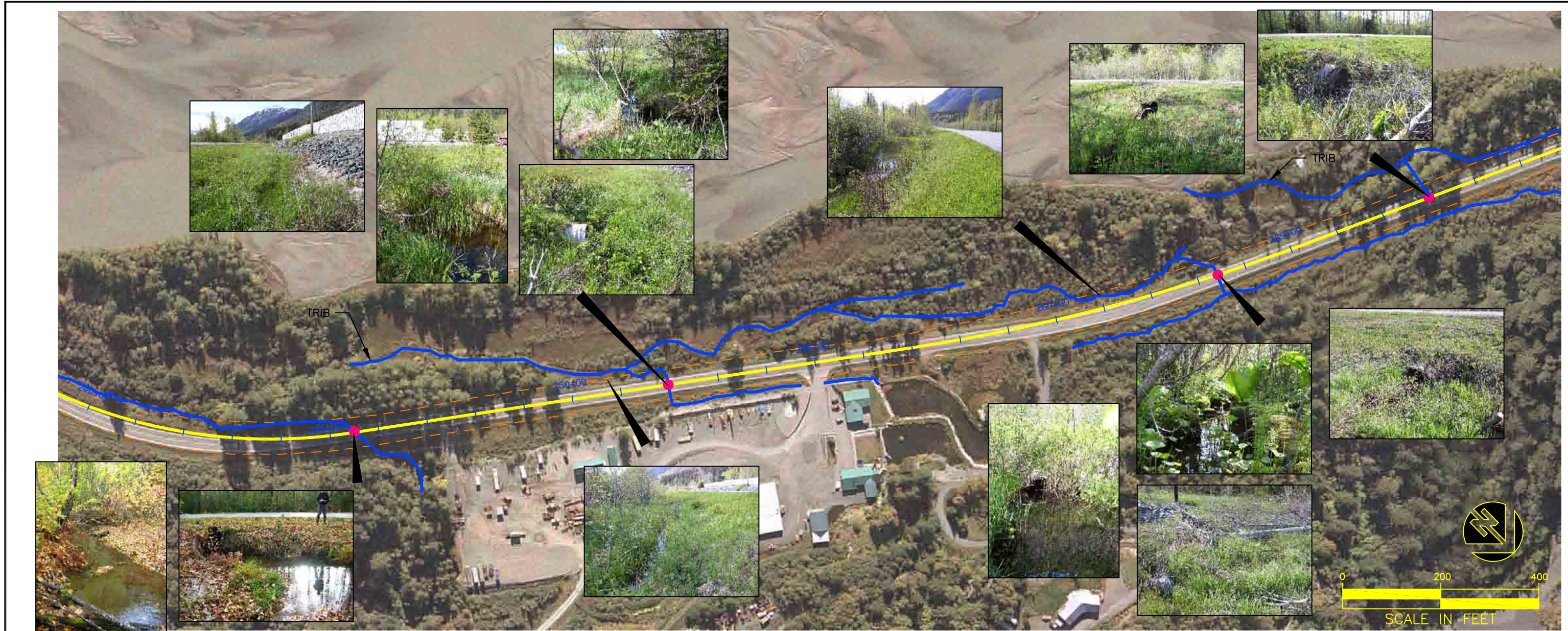

**TRIB STATION/CULVERT
245+50**

CATALOG NUMBER: 115-32-10250-2004
 FISH USE: REARING COHO AND DOLLY VARDEN. SPawning COHO
 DESCRIPTION: UPSTREAM OF THE CULVERT THE STREAM IS A 3-6' WIDE, E TYPE CHANNEL WITH A SUBSTRATE OF MIXED SAND AND ORGANICS. THERE IS A SMALL POOL AT THE CULVERT INLET. DOWNSTREAM OF THE CULVERT THE STREAM WINDS ALONG THE TOE OF THE ROAD FILL SLOPE BACK TO STATION 235+00. THE UPSTREAM HALF OF THIS 1150' SECTION IS ALSO AN E TYPE CHANNEL 3-6' WIDE WITH A SANDY/ORGANIC SUBSTRATE. STREAM BANKS ARE GRASSY, WOODY DEBRIS IS PRESENT AND ALDER OFTEN OVERHANGS THE STREAM. THE LOWER HALF OF THIS SECTION IS INFLUENCED BY THE RIVER BACKWATER, WIDER (6-10'), MORE OPEN AND 6-18" DEEP. SUBSTRATE IS SILT, SAND, FINE GRAVELS AND ORGANIC MATTER. AQUATIC WEEDS SHAPE THE STREAM MEANDER AND BANKS ARE GRASSY OR VEGETATED WITH ALDER AND WILLOW.

**TRIB STATION
245+00 TO 301+00**

NOTE: BETWEEN THESE STATIONS THERE IS A COMPLEX, INTERCONNECTED STREAM SYSTEM THAT RUNS ON BOTH SIDES OF THE HIGHWAY AND CROSSES THE ROAD THROUGH FOUR CULVERTS LOCATED AT STATIONS 252+00, 263+50, 268+00 AND 271+40. THE ADFG CATALOG LISTS TWO MAIN STREAMS IN THIS AREA, AND ONE TRIBUTARY TO EACH OF THOSE STREAMS. DETAILED DESCRIPTIONS AND KNOWN FISH USE ARE LISTED FOR EACH CATALOGUED STREAM, AND THE APPROXIMATE LOCATIONS OF THE INTERCONNECT REACHES ADJACENT TO THE HIGHWAY ARE ILLUSTRATED ON THESE PLAN SHEETS.

**TRIB/CULVERT STATION
252+00**

CATALOG NUMBER: 115-32-10250-2006
 STREAM NAME: SCHNABEL CREEK
 FISH USE: REARING COHO, DOLLY VARDEN AND CUTTHROAT
 DESCRIPTION: UPSTREAM OF THE CULVERT THE STREAM IS 1-2' WIDE AND 1' DEEP. THE STREAM BANKS ARE THICKLY VEGETATED WITH GRASSES THAT TEND TO GROW OVER MOST OF THE STREAM SURFACE. SUBSTRATE IS ORGANIC MATTER OVER GRAVEL. THE STREAM RUNS ALONG THE TOE OF THE SOUTHEAST ROADBUILDERS' FILL, CROSSING THE ACCESS DRIVEWAY AT STATION 255+00 AND THEN CONNECTING TO THE ARTIFICIAL PONDS NEAR 256+00. THE DOWNSTREAM END OF THE CULVERT IS SUBMERGED IN A SMALL POOL, WITH A 2-3' WIDE E TYPE CHANNEL FORMING ALMOST IMMEDIATELY AT THE OUTLET AND MEANDERING THROUGH THE WETLANDS TO CONNECT TO ANOTHER STREAM. THE OUTLET CHANNEL HAS A VERY LOW GRADIENT, A SILTY BOTTOM AND LOW, VERTICAL BANKS VEGETATED WITH MARIGOLDS, SEDGES AND WILLOWS.

**TRIB/CULVERT STATION
263+50**

CATALOG NUMBER: 115-32-10250-2006-3003
 STREAM NAME: NONE, LISTED AS TRIBUTARY TO SCHNABEL CREEK
 FISH USE: REARING COHO, DOLLY VARDEN AND CUTTHROAT
 DESCRIPTION: THIS STREAM IS A TRIBUTARY TO SCHNABEL CREEK AND IS FED BY A WETLAND AND SPRING COMPLEX CUT OFF FROM THE UPPER REACHES OF SCHNABEL CREEK BY THE DRIVEWAY AT STATION 259+25. UPSTREAM OF THE CULVERT THE INLET STREAM FLOWS FROM BOTH DIRECTIONS ALONG THE TOE OF THE ROAD EMBANKMENT. FLOW IS DISPERSED THROUGH A BROAD WETLAND AREA WITH LITTLE IN THE WAY OF A DEFINED CHANNEL. DEPTH IS USUALLY LESS THAN 0.5' OVER A SATURATED ORGANIC BASE. DOWNSTREAM OF THE CULVERT OUTLET IS A 10' BY 15' POOL, WITH A DEPTH OF 3'. THE POOL LEADS INTO A 2' WIDE, 1' DEEP SILT BOTTOMED CHANNEL THAT MEANDERS THROUGH WILLOW AND ALDER ROOT SYSTEMS. THIS CHANNEL WINDS ROUGHLY PARALLEL TO THE ROAD, SWINGING TIGHT TO THE EXISTING EMBANKMENT TOE BETWEEN 260+50 AND 261+00.

**TRIB/CULVERT STATION
268+00**

CATALOG NUMBER: 115-32-10250-2008
 STREAM NAME: WATERFALL CREEK
 FISH USE: REARING COHO, CHINOOK AND DOLLY VARDEN. COHO SPawning
 DESCRIPTION: THE ADFG CATALOG LISTS THIS PIPE AS THE PRIMARY CONDUIT OF WATERFALL CREEK. THIS IS NO LONGER THE CASE. THE CULVERT AT STATION 271+40 NOW PASSES THE MAJORITY OF THE FLOW THAT LEADS FROM THE WATERFALL THE CREEK IS NAMED FOR. UPSTREAM OF THE INLET THERE IS A SHORT, 2' WIDE, SHALLOW STREAM SEGMENT LEADING INTO AN EMERGENT MARSH. THE STREAM SUBSTRATE IS ORGANIC MATTER OVER GRAVEL. THE OUTLET STREAM IS A SHORT, 2' WIDE, 0.7' DEEP SECTION LEADING INTO THE MAIN STREAM THAT FLOWS FROM THE 271+40 CULVERT. THE STREAM BANKS ARE WELL VEGETATED WITH GRASSES.

LEGEND
 ● S&HI CULVERT LOCATION

GENERAL NOTES:
 THE INITIAL STREAM SURVEY WAS CONDUCTED BETWEEN 10/4/05 AND 10/9/05, AND WAS UPDATED IN MAY AND JUNE 2006. THE STREAMS ARE ORGANIZED BY THE STATIONING OF THE HIGHWAY CROSSING CULVERT. WHERE POSSIBLE, THE STREAM HAS BEEN IDENTIFIED BY ITS ALASKA DEPARTMENT OF FISH AND GAME ANADROMOUS WATERS CATALOG (AWC) NUMBER. LISTED FISH USE INCORPORATES FIELD OBSERVATION, MAY 2006 TRAPPING RESULTS BY OHMP, AND AWC NOTES.

HAINES_BASE_SET.dwg

NO.	BY	DATE	REVISION	DESCRIPTION

RP	DM,GK,MS	DM,GK,MS
DRAWN	DESIGNED	CHECKED
DM,GK,MS	06/30/06	
APPROVED	DATE	PROJECT

State of Alaska Department of Transportation
 and Public Facilities - Haines, Alaska
 Haines Highway - MP 3.5 to 25.3

Prepared By:
 Inter-Fluve, Inc.
 1020 Wasco Street, Suite 1
 Hood River, OR 97031
 541.386.9003
 www.interfluve.com

Stream and Habitat Inventory
 Plan View: 240+00 to 270+00



BANK STATION 284+50 TO 288+50:
EULACHON SPAWNING

BANK STATION 296+00 TO 298+50:
EULACHON SPAWNING

TRIB/CULVERT STATION 271+40

CATALOG NUMBER: 115-32-10250-2008-3005
 STREAM NAME: NONE LISTED, TRIBUTARY TO WATERFALL CREEK
 FISH USE: REARING COHO, DOLLY VARDEN, CHINOOK AND CUTTHROAT
 DESCRIPTION: UPSTREAM OF THE CULVERT THE STREAM DISPERSES IMMEDIATELY INTO THICKLY VEGETATED MARSH IN A BROAD REMNANT CHANNEL. THERE ARE A NUMBER OF POOLS WITH DEPTH OF UP TO 3'. THE POOLS ARE FED IN PART BY A SMALL MOUNTAIN STREAM ABOUT 100' FROM THE ROAD. HOWEVER, THE MAJORITY OF THE FLOW COMES FROM THE STREAM AND WETLAND COMPLEX THAT STRETCHES AHEAD ON LINE UP TO THE WATERFALL NEAR STATION 301+00. DOWNSTREAM OF THE CULVERT THE STREAM MEANDERS ALONG THE ROAD TO STATION 269+00 BEFORE TURNING TOWARD THE RIVER. THE STREAM FLOWS THROUGH A MARSH IN A DEFINED CHANNEL, WITH THE BANKS COMPOSED OF THICK VEGETATION. SUBSTRATE IS ORGANIC; DEPTH IS 0.5 - 1'.

GENERAL NOTES:
 THE INITIAL STREAM SURVEY WAS CONDUCTED BETWEEN 10/4/05 AND 10/9/05, AND WAS UPDATED IN MAY AND JUNE 2006. THE STREAMS ARE ORGANIZED BY THE STATIONING OF THE HIGHWAY CROSSING CULVERT. WHERE POSSIBLE, THE STREAM HAS BEEN IDENTIFIED BY ITS ALASKA DEPARTMENT OF FISH AND GAME ANADROMOUS WATERS CATALOG (AWC) NUMBER. LISTED FISH USE INCORPORATES FIELD OBSERVATION, MAY 2006 TRAPPING RESULTS BY OHMP, AND AWC NOTES.

ALL AREAS OF THE CHILKAT RIVER ADJACENT TO THE HIGHWAY LIKELY SERVE AS MIGRATION AND REARING HABITAT FOR ALL FIVE SPECIES OF PACIFIC SALMON AS WELL AS DOLLY VARDEN, CUTTHROAT AND STEELHEAD. HABITAT FUNCTIONS NOTED ON THIS SHEET ARE IN ADDITION TO THESE USES.

LEGEND

-  VEGETATED RIPRAP
-  S&HI CULVERT LOCATION

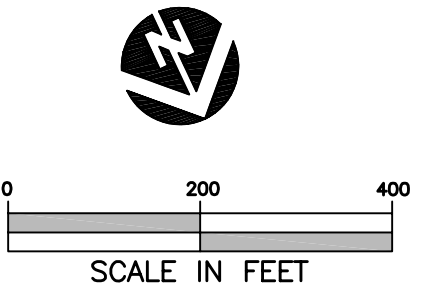

HAINES_BASE_SET.dwg

NO.	BY	DATE	REVISION	DESCRIPTION

RP	DM,GK,MS	DM,GK,MS
DRAWN	DESIGNED	CHECKED
DM,GK,MS	06/30/06	PROJECT
APPROVED	DATE	

State of Alaska Department of Transportation
 and Public Facilities – Haines, Alaska
 Haines Highway – MP 3.5 to 25.3

Prepared By:
 Inter-Fluve, Inc.
 1020 Wasco Street, Suite 1
 Hood River, OR 97031
 541.386.9003
 www.interfluve.com

Stream and Habitat Inventory
 Plan View: 270+00 to 300+00

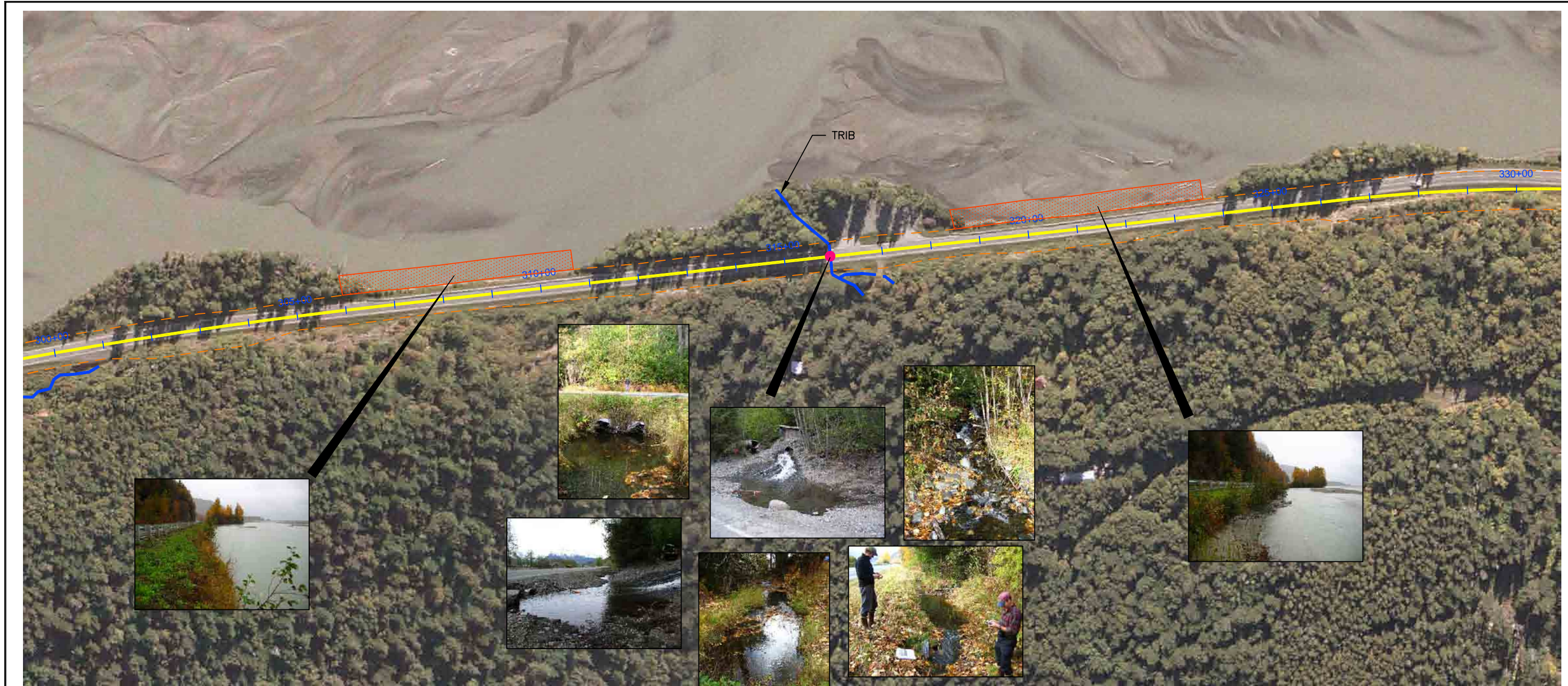

BANK STATION 306+00 TO 310+75:
EULACHON SPAWNING

BANK STATION 318+50 TO 323+75:
EULACHON SPAWNING

TRIB STATION 316+00



GENERAL NOTES:

THE INITIAL STREAM SURVEY WAS CONDUCTED BETWEEN 10/4/05 AND 10/9/05, AND WAS UPDATED IN MAY AND JUNE 2006. THE STREAMS ARE ORGANIZED BY THE STATIONING OF THE HIGHWAY CROSSING CULVERT. WHERE POSSIBLE, THE STREAM HAS BEEN IDENTIFIED BY ITS ALASKA DEPARTMENT OF FISH AND GAME ANADROMOUS WATERS CATALOG (AWC) NUMBER. LISTED FISH USE INCORPORATES FIELD OBSERVATION, MAY 2006 TRAPPING RESULTS BY OHMP, AND AWC NOTES.

ALL AREAS OF THE CHILKAT RIVER ADJACENT TO THE HIGHWAY LIKELY SERVE AS MIGRATION AND REARING HABITAT FOR ALL FIVE SPECIES OF PACIFIC SALMON AS WELL AS DOLLY VARDEN, CUTTHROAT AND STEELHEAD. HABITAT FUNCTIONS NOTED ON THIS SHEET ARE IN ADDITION TO THESE USES.

FISH USE: REARING COHO, CUTTHROAT, CHINOOK AND DOLLY VARDEN. SPAWNING REDDS PRESENT DESCRIPTION: UPSTREAM OF THE CULVERT THERE IS A LARGE, SHALLOW, GRAVEL BOTTOMED POOL EXCAVATED AFTER THE NOVEMBER 2005 FLOOD. THIS POOL IS FED PRIMARILY BY A 4' WIDE CASCADE THAT PASSES THROUGH A CULVERT IN THE ADJACENT DRIVEWAY. ANOTHER MOUNTAIN STREAM NEAR STATION 317+00 PROVIDES ANOTHER 10% OF THE FLOW. ALL FISH HABITAT ABOVE THE CULVERT HAS BEEN SCOURED TO GRAVEL. REDDS WERE PRESENT IN THIS SECTION IN OCTOBER 2005. THIS STREAM IS USED FOR A SMALL HYDROPOWER SYSTEM. DOWNSTREAM OF THE CULVERT IS A 10' WIDE GRAVEL BOTTOMED PLUNGE POOL WITH REDDS PRESENT (OCTOBER 2005) AT THE TAILOUT. THE STREAM THEN FLOWS DIRECTLY TO THE RIVER IN A 6-10' WIDE, ROCKY CASCADE CHANNEL, THE LOWER END OF WHICH IS INFLUENCED BY THE RIVER BACKWATER.

LEGEND

-  VEGETATED RIPRAP
-  S&HI CULVERT LOCATION

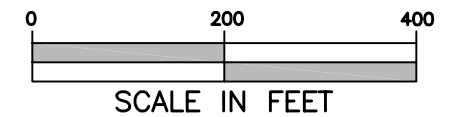

HAINES_BASE_SET.dwg

NO.	BY	DATE	REVISION	DESCRIPTION

RP	DM,GK,MS	DM,GK,MS
DRAWN	DESIGNED	CHECKED
DM,GK,MS	06/30/06	
APPROVED	DATE	PROJECT

State of Alaska Department of Transportation
and Public Facilities – Haines, Alaska
Haines Highway – MP 3.5 to 25.3

Prepared By:
Inter-Fluve, Inc.
1020 Wasco Street, Suite 1
Hood River, OR 97031
541.386.9003
www.interfluve.com

Stream and Habitat Inventory
Plan View: 300+00 to 330+00

SHEET
5 of 36

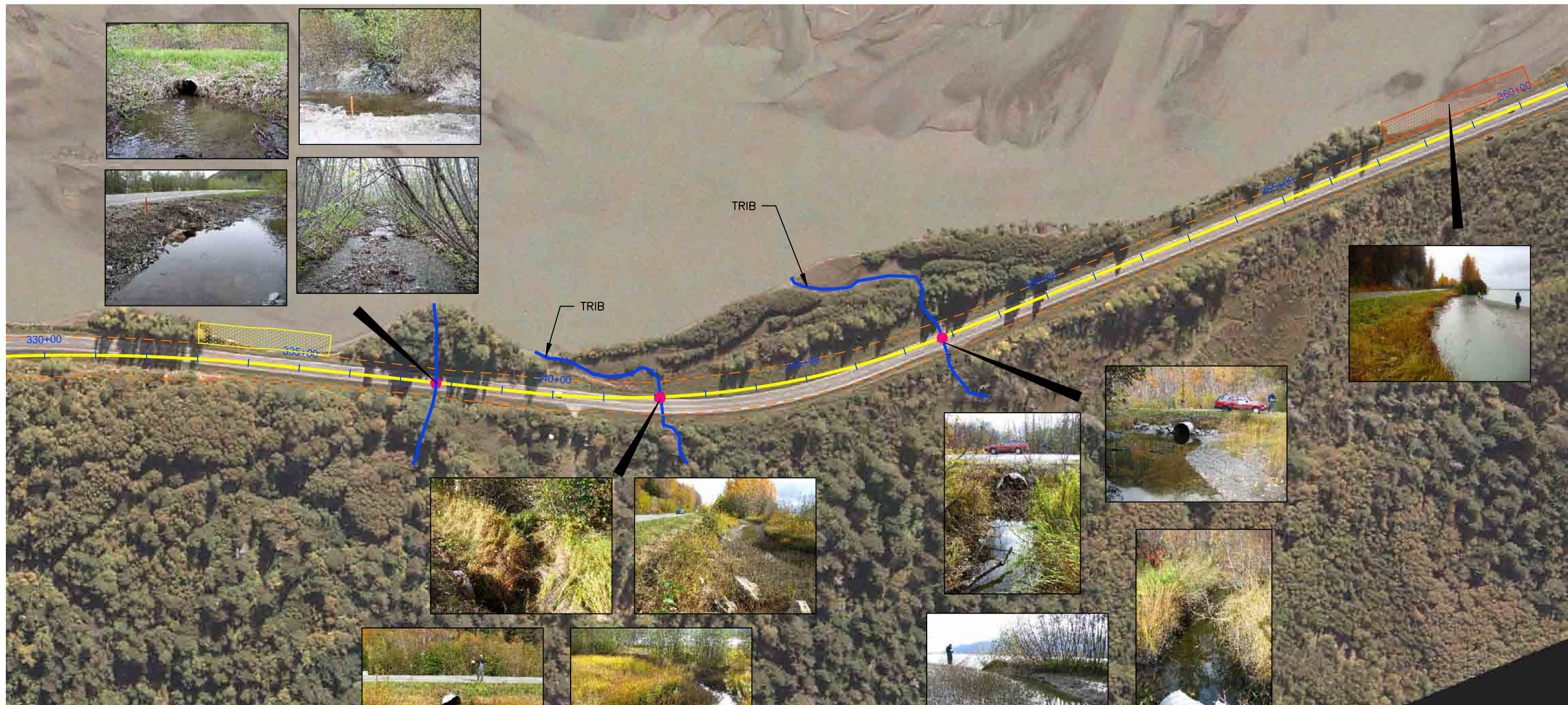

**BANK STATION 333+00 TO 335+50:
EULACHON SPAWNING**



TRIB STATION 337+70

FISH USE: REARING COHO AND DOLLY VARDEN BELOW CULVERT OUTLET
 DESCRIPTION: UPSTREAM OF THE CULVERT THERE IS A 10' BY 30' POOL CREATED BY DITCH CLEANING ACTIVITY IN THE SPRING OF 2006. THIS SHALLOW POOL IS FED BY A STREAM CASCADING DOWN THE CUT SLOPE ADJACENT TO THE POOL. THE INLET STREAM AVERAGES 4' WIDE AND 0.1' DEEP AND IS WELL DEFINED FURTHER UPSTREAM. DOWNSTREAM OF THE CULVERT IS AN 8' DIAMETER PLUNGE POOL 1.5' DEEP. THE CULVERT WAS NOT PERCHED IN LATE MAY OF 2006. THE STREAM MEANDERS THE 140' TO THE CHILKAT RIVER THROUGH AN 8' WIDE, HIGH BANKED CHANNEL. THE CHANNEL BANKS ARE THICKLY VEGETATED WITH ALDER AND COTTONWOOD. THE STREAM MEANDERS WITHIN THIS CHANNEL, WITH WIDTH VARYING FROM 1-3', AND DEPTH 0.2' TO 0.8'. IT IS COMPOSED OF POOLS AND RIFFLES OVER GRAVEL.

TRIB STATION 342+00

FISH USE: REARING COHO, CHINOOK AND DOLLY VARDEN
 DESCRIPTION: UPSTREAM OF THE CULVERT THE COMPLEX CHANNEL OF THE STREAM MEANDERS AMONG ALDER ROOTS AND DOWNFALL. THE STREAM IS 1-3' WIDE WITH A SUBSTRATE OF GRAVEL AND ORGANICS. DEPTH IS 6-8" AND OVERHANGING COVER IS DENSE. THE DOWNSTREAM END OF THE CULVERT IS PERCHED 3-4" AND UNRAVELED. THE STREAM MEANDERS ALONG THE ROAD BACK TO STATION 339+75 BEFORE ENTERING THE CHILKAT RIVER. THE RIVER BACKWATERS THE STREAM AND DEPOSITS SILT OVER THE GRAVEL BED. THE STREAM IS 4-6' WIDE AND 3-4" DEEP. IT LIES IN AN OLD FLOOD CHANNEL OF THE RIVER. STREAM BANKS ARE GRASS COVERED.

TRIB STATION 347+50

CATALOG NUMBER: 115-32-10250-2014
 STREAM NAME: SEVEN MILE CREEK
 FISH USE: REARING COHO AND DOLLY VARDEN
 DESCRIPTION: THE CULVERT APPEARS TO BE FAIRLY RECENTLY REPLACED. UPSTREAM OF THE CULVERT THE STREAM IS A 1-2' WIDE E TYPE CHANNEL WITH A FINE SILT AND GRAVEL SUBSTRATE. THE STREAM DRAINS A SWAMP FED BY NUMEROUS SPRINGS ALONG THE TOE OF THE MOUNTAIN. THE CULVERT OUTLET EMPTIES INTO A SHORT SECTION OF GRAVEL BOTTOMED STREAM WITH A WIDTH OF 2-3' AND GRASSY BANKS. THE STREAM THEN TURNS INTO A 3-6' WIDE BACKWATERED SLOUGH WITH A SILT SUBSTRATE. SPRINGS FEED THIS SECTION OF THE STREAM.

**BANK STATION 357+25 TO 360+25:
EULACHON SPAWNING**



LEGEND

- VEGETATED RIPRAP
- HERBACEOUS - VEGETATED
- S&HI CULVERT LOCATION

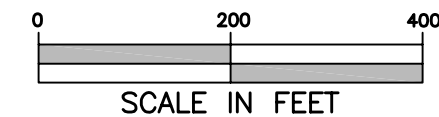

HAINES_BASE_SET.dwg

NO.	BY	DATE	REVISION	DESCRIPTION

RP	DM,GK,MS	DM,GK,MS
DRAWN	DESIGNED	CHECKED
DM,GK,MS	06/30/06	PROJECT
APPROVED	DATE	PROJECT

State of Alaska Department of Transportation
 and Public Facilities - Haines, Alaska
 Haines Highway - MP 3.5 to 25.3

Prepared By:
 Inter-Fluve, Inc.
 1020 Wasco Street, Suite 1
 Hood River, OR 97031
 541.386.9003
 www.interfluve.com

Stream and Habitat Inventory
 Plan View: 330+00 to 360+00

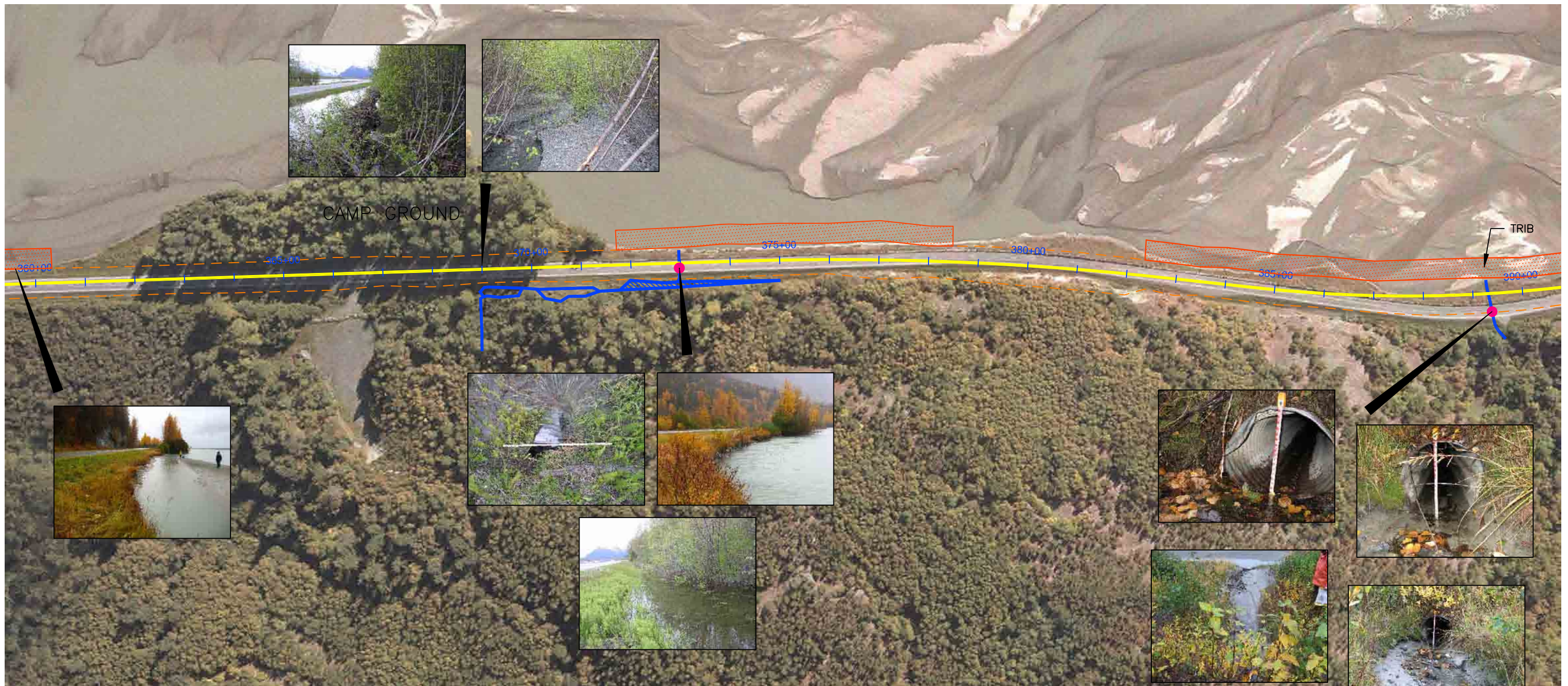

BANK STATION 357+25 TO 360+25:
EULACHON SPAWNING

BANK STATION 371+75 TO 378+50:
POSSIBLE EULACHON SPAWNING

BANK STATION 382+25 TO 398+50

TRIB STATION 389+25
FISH USE: REARING COHO, CUTTHROAT AND DOLLY VARDEN
DESCRIPTION: UPSTREAM OF THE CULVERT THE 2-4' WIDE STREAM PROVIDES 40' OF EXCELLENT REARING HABITAT FOR JUVENILE FISH AFTER IT CASCADES DOWN THE HILLSIDE. SUBSTRATE IS GRAVEL AND THE COVER IS DENSE. DOWNSTREAM OF THE CULVERT THE STREAM RUNS THROUGH A CHANNEL INCISED IN A RIVER DEPOSITED SANDBAR AND DUMPS DIRECTLY INTO THE CHILKAT RIVER.

TRIB STATION 373+00
FISH USE: REARING COHO AND DOLLY VARDEN, IF PASSAGE NOT BLOCKED. NOT TRAPPED BY OHMP DURING MAY 2006 FIELD INVESTIGATIONS.
DESCRIPTION: THE LOCATION OF THIS STREAM IS NEW SINCE THE FLOOD EVENT OF 11/06. THE NEW STREAM CHANNEL NOW INTERSECTS THE ROAD AT STATION 369+00. ABOVE THE ROAD, THE STREAM FLOWS THROUGH A CHANNEL CARVED IN NEWLY DEPOSITED ALLUVIAL MATERIAL. AT THE ROAD THE STREAM RUNS THROUGH A NEW CHANNEL EXCAVATED BY ADOT&PF, FLOWING WEST ALONG THE ROAD. THERE IS ALSO A SLOWLY FLOWING POND IN THE DITCH-LINE. BOTH THESE FLOWS LEAD TO A +3' DEEP POOL THAT STARTS AT STATION 372+50 AND EXTENDS UP TO STATION 375+00. THE POOL DRAINS TO THE RIVER THROUGH A CULVERT AT STATION 373+00. THE INLET OF THIS CULVERT IS CLOGGED WITH ORGANIC MATTER AND THE STREAM ENTERS ONLY NEAR THE TOP OF THE PIPE.
THE CULVERT EMPTIES DIRECTLY INTO THE CHILKAT RIVER.

GENERAL NOTES:
THE INITIAL STREAM SURVEY WAS CONDUCTED BETWEEN 10/4/05 AND 10/9/05, AND WAS UPDATED IN MAY AND JUNE 2006. THE STREAMS ARE ORGANIZED BY THE STATIONING OF THE HIGHWAY CROSSING CULVERT. WHERE POSSIBLE, THE STREAM HAS BEEN IDENTIFIED BY ITS ALASKA DEPARTMENT OF FISH AND GAME ANADROMOUS WATERS CATALOG (AWC) NUMBER. LISTED FISH USE INCORPORATES FIELD OBSERVATION, MAY 2006 TRAPPING RESULTS BY OHMP, AND AWC NOTES.

ALL AREAS OF THE CHILKAT RIVER ADJACENT TO THE HIGHWAY LIKELY SERVE AS MIGRATION AND REARING HABITAT FOR ALL FIVE SPECIES OF PACIFIC SALMON AS WELL AS DOLLY VARDEN, CUTTHROAT AND STEELHEAD. HABITAT FUNCTIONS NOTED ON THIS SHEET ARE IN ADDITION TO THESE USES.

LEGEND

- VEGETATED RIPRAP
- S&HI CULVERT LOCATION

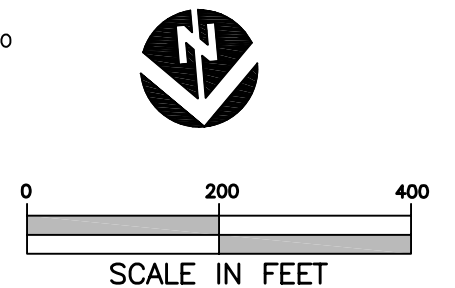

HAINES_BASE_SET.dwg

NO.	BY	DATE	REVISION	DESCRIPTION

RP	DM,GK,MS	DM,GK,MS
DRAWN	DESIGNED	CHECKED
DM,GK,MS	06/30/06	
APPROVED	DATE	PROJECT

State of Alaska Department of Transportation
and Public Facilities – Haines, Alaska
Haines Highway – MP 3.5 to 25.3

Prepared By:
Inter-Fluve, Inc.
1020 Wasco Street, Suite 1
Hood River, OR 97031
541.386.9003
www.interfluve.com

Stream and Habitat Inventory
Plan View: 360+00 to 390+00

SHEET
7 of 36

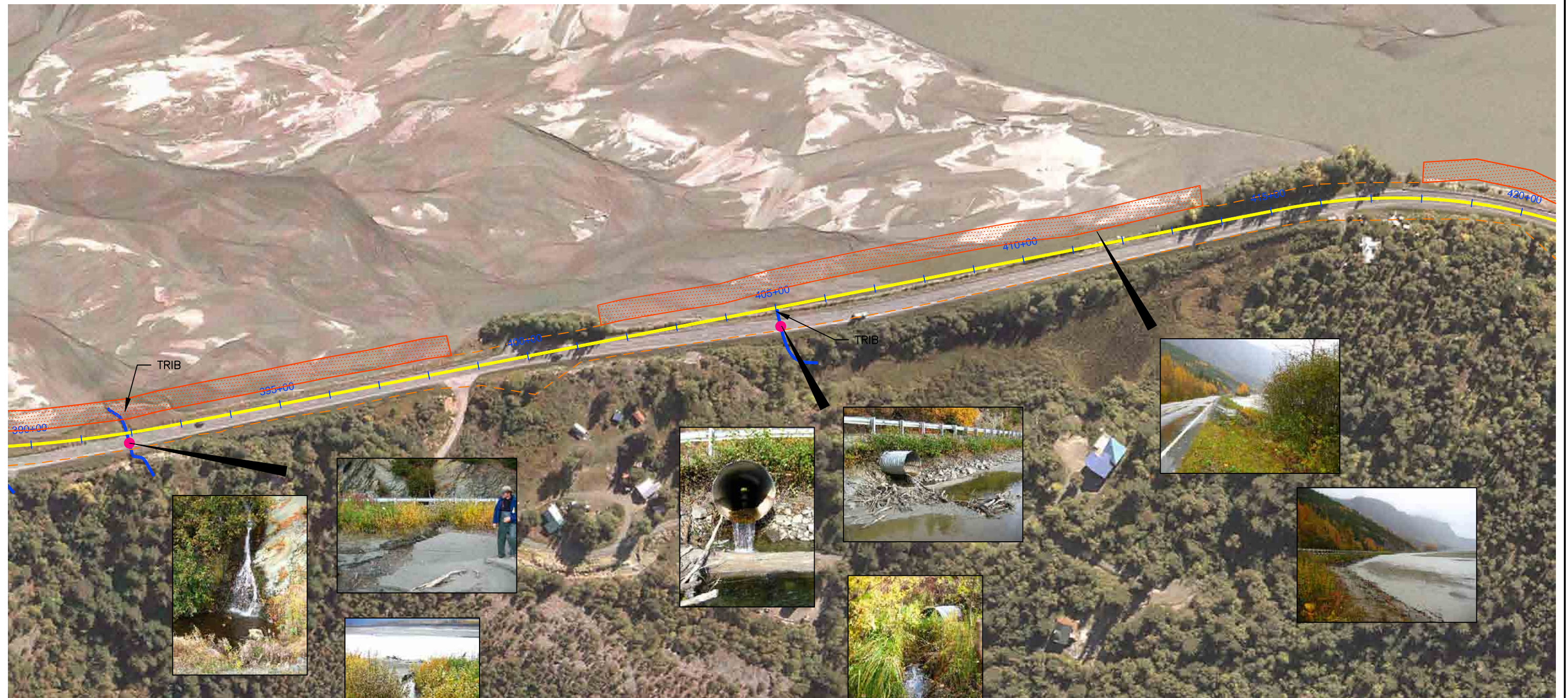

BANK STATION 382+25
TO 398+50

BANK STATION 401+50
TO 413+75

BANK STATION 418+00
TO 428+25

GENERAL NOTES:
THE INITIAL STREAM SURVEY WAS CONDUCTED BETWEEN 10/4/05 AND 10/9/05, AND WAS UPDATED IN MAY AND JUNE 2006. THE STREAMS ARE ORGANIZED BY THE STATIONING OF THE HIGHWAY CROSSING CULVERT. WHERE POSSIBLE, THE STREAM HAS BEEN IDENTIFIED BY ITS ALASKA DEPARTMENT OF FISH AND GAME ANADROMOUS WATERS CATALOG (AWC) NUMBER. LISTED FISH USE INCORPORATES FIELD OBSERVATION, MAY 2006 TRAPPING RESULTS BY OHMP, AND AWC NOTES.

ALL AREAS OF THE CHILKAT RIVER ADJACENT TO THE HIGHWAY LIKELY SERVE AS MIGRATION AND REARING HABITAT FOR ALL FIVE SPECIES OF PACIFIC SALMON AS WELL AS DOLLY VARDEN, CUTTHROAT AND STEELHEAD. HABITAT FUNCTIONS NOTED ON THIS SHEET ARE IN ADDITION TO THESE USES.

TRIB STATION 391+90

FISH USE: REARING COHO AND DOLLY VARDEN
DESCRIPTION: UPSTREAM OF THE CULVERT THERE IS A 10' DIAMETER GRAVEL BOTTOMED POOL FED BY A WATERFALL. DOWNSTREAM OF THE CULVERT THE STREAM RUNS THROUGH A SHORT SECTION WITH VEGETATED BANKS AND THEN FEEDS OUT ONTO A SANDBAR OF THE CHILKAT RIVER. THE STREAM IS 2-3' WIDE AND 4" DEEP, WITH A GRAVEL AND BACKWATERED SILT BOTTOM.

TRIB STATION 405+00

CATALOG NUMBER: 115-32-10250-2016
STREAM NAME: LILYPAD CREEK
FISH USE: REARING COHO AND DOLLY VARDEN
DESCRIPTION: UPSTREAM OF THE CULVERT THE FIRST 50' OF THE STREAM CONSISTS OF A 2' WIDE E TYPE CHANNEL. THE STREAM THEN DISPERSES INTO A SWAMP AND LOSES ANY DEFINED CHANNEL. AT THE DOWNSTREAM END OF THE CULVERT THE STREAM PLUNGES DIRECTLY ONTO A SANDBAR. THERE IS AN INTERMITTENT POOL AND SHALLOW EXIT STREAM OVER THE SANDBAR. REARING FISH ACCESS TO THE SWAMP IS CONTROLLED BY THE RIVER WATER LEVEL.

LEGEND

-  VEGETATED RIPRAP
-  S&HI CULVERT LOCATION

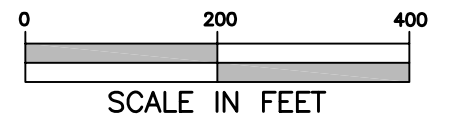

HAINES_BASE_SET.dwg

NO.	BY	DATE	REVISION	DESCRIPTION

RP	DM,GK,MS	DM,GK,MS
DRAWN	DESIGNED	CHECKED
DM,GK,MS	06/30/06	
APPROVED	DATE	PROJECT

State of Alaska Department of Transportation
and Public Facilities – Haines, Alaska
Haines Highway – MP 3.5 to 25.3

Prepared By:
Inter-Fluve, Inc.
1020 Wasco Street, Suite 1
Hood River, OR 97031
541.386.9003
www.interfluve.com

Stream and Habitat Inventory
Plan View: 390+00 to 420+00

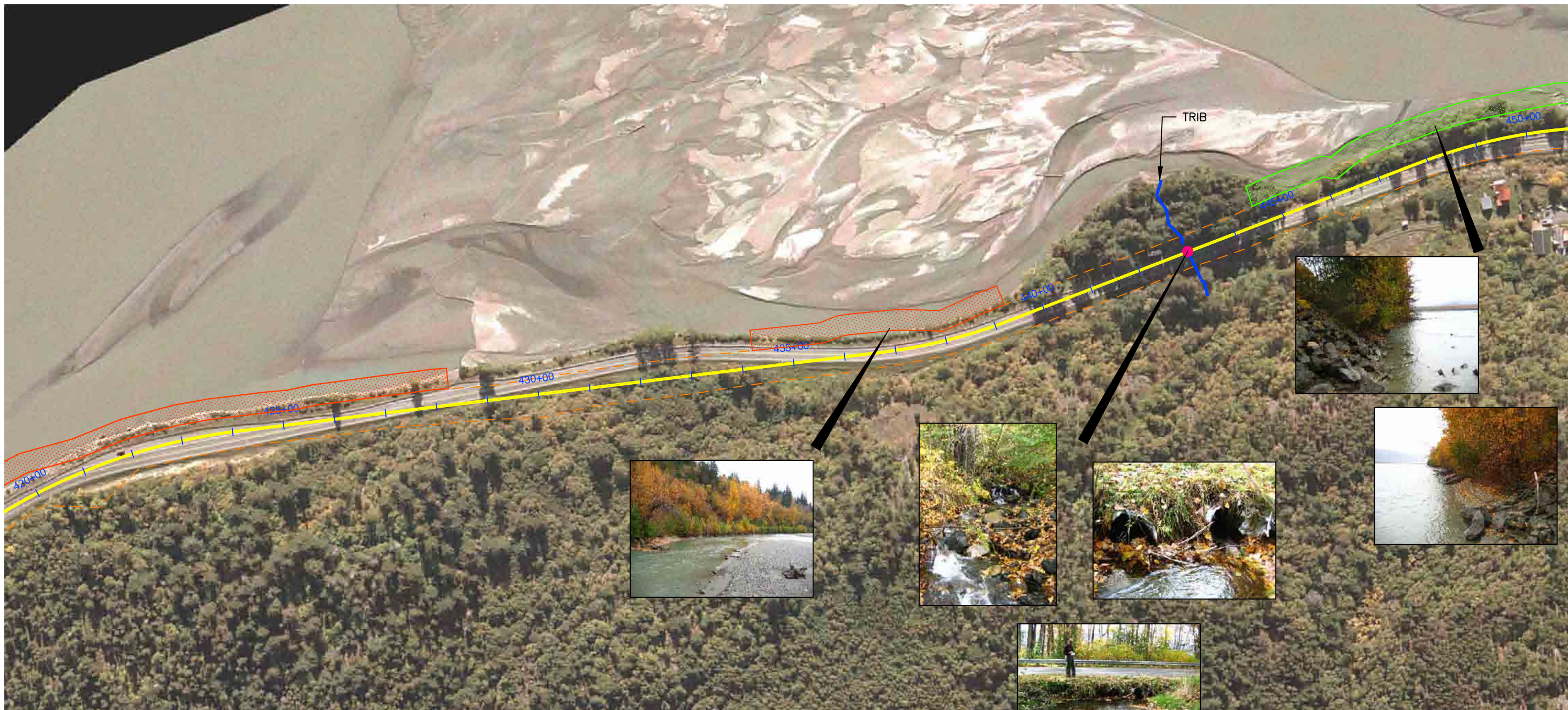

BANK STATION 418+00
TO 428+25

BANK STATION 434+25
TO 439+25:
SALMON SPAWNING

BANK STATION 444+50
TO 459+00



TRIB STATION 443+00

FISH USE: REARING COHO, CUTTHROAT, STEELHEAD AND DOLLY VARDEN. POSSIBLE SPAWNING DESCRIPTION: UPSTREAM OF THE CULVERTS THERE IS A 20' DIAMETER GRAVEL LINED POOL FED BY A QUICKLY STEEPENING, 3-5' WIDE, ROCKY CASCADE/STEP POOL SECTION OF STREAM. THE CULVERTS EMPTY INTO A 6-8' DIAMETER PLUNGE POOL. THE ACTIVE CULVERT IS PERCHED 4-6". THE STREAM BELOW THE OUTLET POOL IS COMPOSED OF RIFFLES INTERSPERSED WITH STEP POOLS AND IS 3-6' WIDE. SUBSTRATE IS SMALL ROCKS AND GRAVEL. MATURE VEGETATION OVERHANGS THE STREAM.

GENERAL NOTES:
THE INITIAL STREAM SURVEY WAS CONDUCTED BETWEEN 10/4/05 AND 10/9/05, AND WAS UPDATED IN MAY AND JUNE 2006. THE STREAMS ARE ORGANIZED BY THE STATIONING OF THE HIGHWAY CROSSING CULVERT. WHERE POSSIBLE, THE STREAM HAS BEEN IDENTIFIED BY ITS ALASKA DEPARTMENT OF FISH AND GAME ANADROMOUS WATERS CATALOG (AWC) NUMBER. LISTED FISH USE INCORPORATES FIELD OBSERVATION, MAY 2006 TRAPPING RESULTS BY OHMP, AND AWC NOTES.

ALL AREAS OF THE CHILKAT RIVER ADJACENT TO THE HIGHWAY LIKELY SERVE AS MIGRATION AND REARING HABITAT FOR ALL FIVE SPECIES OF PACIFIC SALMON AS WELL AS DOLLY VARDEN, CUTTHROAT AND STEELHEAD. HABITAT FUNCTIONS NOTED ON THIS SHEET ARE IN ADDITION TO THESE USES.

LEGEND

-  VEGETATED RIPRAP
-  MIDMATURITY-FORESTED
-  S&HI CULVERT LOCATION

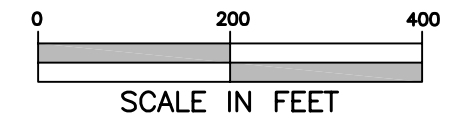

HAINES_BASE_SET.dwg

NO.	BY	DATE	REVISION	DESCRIPTION

RP	DM,GK,MS	DM,GK,MS
DRAWN	DESIGNED	CHECKED
DM,GK,MS	06/30/06	
APPROVED	DATE	PROJECT

State of Alaska Department of Transportation
and Public Facilities - Haines, Alaska
Haines Highway - MP 3.5 to 25.3

Prepared By:
Inter-Fluve, Inc.
1020 Wasco Street, Suite 1
Hood River, OR 97031
541.386.9003
www.interfluve.com

Stream and Habitat Inventory
Plan View: 420+00 to 450+00

SHEET
9 of 36



BANK STATION 444+50
TO 457+50

BANK STATION 461+50
TO 469+25

GENERAL NOTES:

THE INITIAL STREAM SURVEY WAS CONDUCTED BETWEEN 10/4/05 AND 10/9/05, AND WAS UPDATED IN MAY AND JUNE 2006. THE STREAMS ARE ORGANIZED BY THE STATIONING OF THE HIGHWAY CROSSING CULVERT. WHERE POSSIBLE, THE STREAM HAS BEEN IDENTIFIED BY ITS ALASKA DEPARTMENT OF FISH AND GAME ANADROMOUS WATERS CATALOG (AWC) NUMBER. LISTED FISH USE INCORPORATES FIELD OBSERVATION, MAY 2006 TRAPPING RESULTS BY OHMP, AND AWC NOTES.

ALL AREAS OF THE CHILKAT RIVER ADJACENT TO THE HIGHWAY LIKELY SERVE AS MIGRATION AND REARING HABITAT FOR ALL FIVE SPECIES OF PACIFIC SALMON AS WELL AS DOLLY VARDEN, CUTTHROAT AND STEELHEAD. HABITAT FUNCTIONS NOTED ON THIS SHEET ARE IN ADDITION TO THESE USES.

LEGEND

-  VEGETATED RIPRAP
-  MIDMATURITY-FORESTED

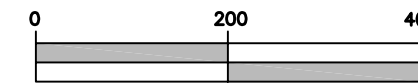

SCALE IN FEET

HAINES_BASE_SET.dwg

NO.	BY	DATE	REVISION	DESCRIPTION

RP DRAWN	DM,GK,MS DESIGNED	DM,GK,MS CHECKED
DM,GK,MS APPROVED	06/30/06 DATE	PROJECT

State of Alaska Department of Transportation
and Public Facilities – Haines, Alaska
Haines Highway – MP 3.5 to 25.3

Prepared By:
Inter-Fluve, Inc.

1020 Wasco Street, Suite 1
Hood River, OR 97031
541.386.9003
www.interfluve.com

Stream and Habitat Inventory
Plan View: 450+00 to 480+00

SHEET
10 of 36



BANK STATION 481+50
TO 492+75

TRIB STATION 506+25

CATALOG NUMBER: 115-32-10250-2024
 STREAM NAME: 9½ MILE CREEK
 FISH USE: REARING COHO AND DOLLY VARDEN
 DESCRIPTION: UPSTREAM OF THE CULVERT THE STREAM IS ABOUT 8' WIDE AND FLOWS OVER A SILT/ORGANIC SUBSTRATE. THE STREAM IS BACKWATERED BY THE CHILKAT RIVER AND HAD A DEPTH OF 6-8" AT THE TIME OF THE SURVEY. BANKS ARE MUDDY AND GRASSY, WITH WILLOW AND ALDER GROWING CLOSE TO THE WATER ON ONE SIDE. THE CULVERT EMPTIES INTO A 30' DIAMETER POOL WITH A DEPTH OF 3'. BANKS ARE SILTY UP TO THE LEVEL OF FREQUENT RIVER BACKWATER AND THEN FORMED OF GRASS AND YOUNG WILLOW/ALDER. SUBSTRATE IS SILT. DOWNSTREAM OF THE POOL THE CHANNEL IS 10' WIDE BUT TERMINATES ABRUPTLY AT A SANDBAR ABOUT 125' FROM THE ROAD. A SMALL TRICKLE FLOWS OVER THE SANDBAR AND INTO AN ISOLATED POOL. FISH ACCESS IS DEPENDENT ON THE RIVER WATER LEVEL.

GENERAL NOTES:
 THE INITIAL STREAM SURVEY WAS CONDUCTED BETWEEN 10/4/05 AND 10/9/05, AND WAS UPDATED IN MAY AND JUNE 2006. THE STREAMS ARE ORGANIZED BY THE STATIONING OF THE HIGHWAY CROSSING CULVERT. WHERE POSSIBLE, THE STREAM HAS BEEN IDENTIFIED BY ITS ALASKA DEPARTMENT OF FISH AND GAME ANADROMOUS WATERS CATALOG (AWC) NUMBER. LISTED FISH USE INCORPORATES FIELD OBSERVATION, MAY 2006 TRAPPING RESULTS BY OHMP, AND AWC NOTES.

ALL AREAS OF THE CHILKAT RIVER ADJACENT TO THE HIGHWAY LIKELY SERVE AS MIGRATION AND REARING HABITAT FOR ALL FIVE SPECIES OF PACIFIC SALMON AS WELL AS DOLLY VARDEN, CUTTHROAT AND STEELHEAD. HABITAT FUNCTIONS NOTED ON THIS SHEET ARE IN ADDITION TO THESE USES.

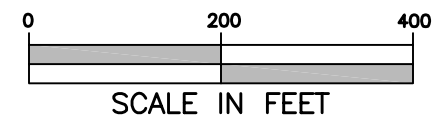

LEGEND

- VEGETATED RIPRAP
- S&HI CULVERT LOCATION

HAINES_BASE_SET.dwg

NO.	BY	DATE	REVISION	DESCRIPTION

RP	DM,GK,MS	DM,GK,MS
DRAWN	DESIGNED	CHECKED
DM,GK,MS	06/30/06	
APPROVED	DATE	PROJECT

State of Alaska Department of Transportation
 and Public Facilities – Haines, Alaska
 Haines Highway – MP 3.5 to 25.3

Prepared By:
 Inter-Fluve, Inc.

1020 Wasco Street, Suite 1
 Hood River, OR 97031
 541.386.9003
 www.interfluve.com

Stream and Habitat Inventory
 Plan View: 480+00 to 510+00

SHEET
 11 of 36

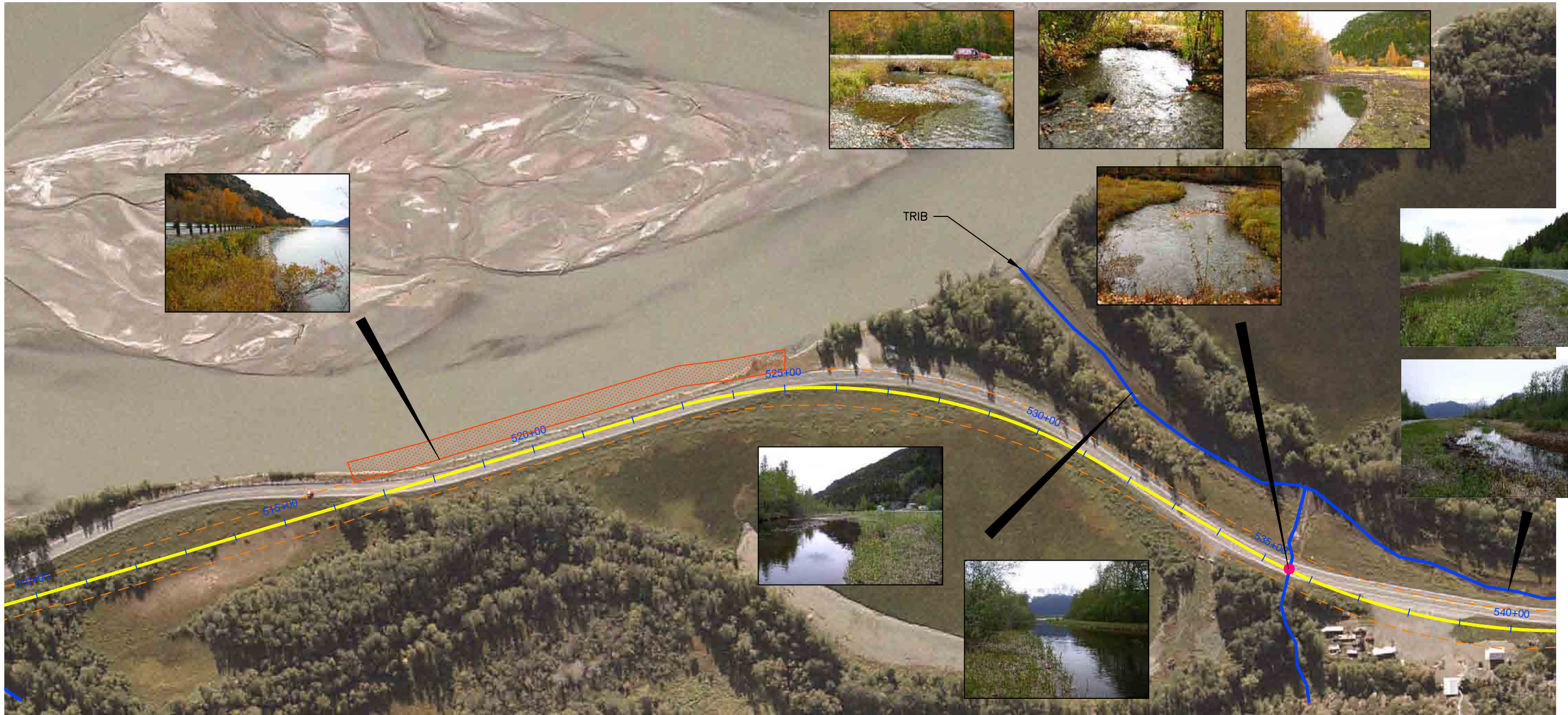

BANK STATION 516+50 TO 525+00

TRIB STATION 528+50 TO 594+75

STATION 535+50

CATALOG NUMBER: 115-32-10250-2028
 STREAM NAME: TEN MILE SLOUGH
 FISH USE: COHO, STEELHEAD AND DOLLY VARDEN REARING. PINK AND CHUM SALMON SPAWNING
 DESCRIPTION: THIS LONG SLOUGH FOLLOWS THE PATH OF A REMNANT CHILKAT RIVER CHANNEL AND IS FED PRIMARILY BY GROUNDWATER. THE LOWER END OF THE SLOUGH PROVIDES THE OUTLET CHANNEL FOR TEN MILE CREEK AND IS OFTEN BACKWATERED BY THE CHILKAT RIVER. THE LEVEL OF THE CHILKAT AND THE GROUNDWATER CONTROL THE WATER LEVEL IN THE SLOUGH. THIS SLOUGH IS CATALOGUED UP TO STATION 594+75. IN MAY OF 2006, WATER FLOW WAS VISIBLE THROUGHOUT THE LENGTH OF THE SLOUGH.

CATALOG NUMBER: 115-32-10250-2028-3002
 STREAM NAME: 10 MILE CREEK
 FISH USE: REARING COHO AND DOLLY VARDEN. SPAWNING PINK AND CHUM
 DESCRIPTION: UPSTREAM OF THE CULVERTS THE STREAM IS ABOUT 15' WIDE AND FLOWS IN RIFFLES OVER IDEAL SPAWNING GRAVELS. THE BANKS ARE WELL VEGETATED AND OVERHANG THE STREAM. A HYDROELECTRIC PLANT IS UPSTREAM. DOWNSTREAM OF THE CULVERTS THE STREAM VARIES IN WIDTH FROM 15-20', THE BOTTOM IS GRAVEL AND THE STREAM IS HEAVILY UTILIZED BY SPAWNING SALMON. STREAM BANKS ARE FULLY VEGETATED WITH GRASSES. FURTHER DOWNSTREAM THE STREAM MEANDERS THROUGH A WIDE, OLD RIVER CHANNEL THAT IS FREQUENTLY BACKWATERED BY THE RIVER.

GENERAL NOTES:
 THE INITIAL STREAM SURVEY WAS CONDUCTED BETWEEN 10/4/05 AND 10/9/05, AND WAS UPDATED IN MAY AND JUNE 2006. THE STREAMS ARE ORGANIZED BY THE STATIONING OF THE HIGHWAY CROSSING CULVERT. WHERE POSSIBLE, THE STREAM HAS BEEN IDENTIFIED BY ITS ALASKA DEPARTMENT OF FISH AND GAME ANADROMOUS WATERS CATALOG (AWC) NUMBER. LISTED FISH USE INCORPORATES FIELD OBSERVATION, MAY 2006 TRAPPING RESULTS BY OHMP, AND AWC NOTES.

ALL AREAS OF THE CHILKAT RIVER ADJACENT TO THE HIGHWAY LIKELY SERVE AS MIGRATION AND REARING HABITAT FOR ALL FIVE SPECIES OF PACIFIC SALMON AS WELL AS DOLLY VARDEN, CUTTHROAT AND STEELHEAD. HABITAT FUNCTIONS NOTED ON THIS SHEET ARE IN ADDITION TO THESE USES.

LEGEND

-  VEGETATED RIPRAP
-  S&HI CULVERT LOCATION

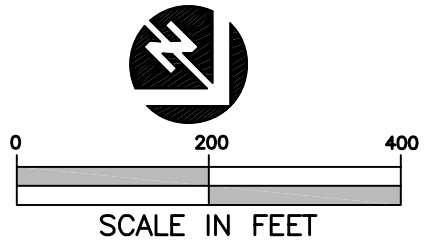

HAINES_BASE_SET.dwg

NO.	BY	DATE	REVISION	DESCRIPTION

RP	DM,GK,MS	DM,GK,MS
DRAWN	DESIGNED	CHECKED
DM,GK,MS	06/30/06	
APPROVED	DATE	PROJECT

State of Alaska Department of Transportation
 and Public Facilities – Haines, Alaska
 Haines Highway – MP 3.5 to 25.3

Prepared By:
 Inter-Fluve, Inc.
 1020 Wasco Street, Suite 1
 Hood River, OR 97031
 541.386.9003
 www.interfluve.com

Stream and Habitat Inventory
 Plan View: 510+00 to 540+00
 SHEET 12 OF 36

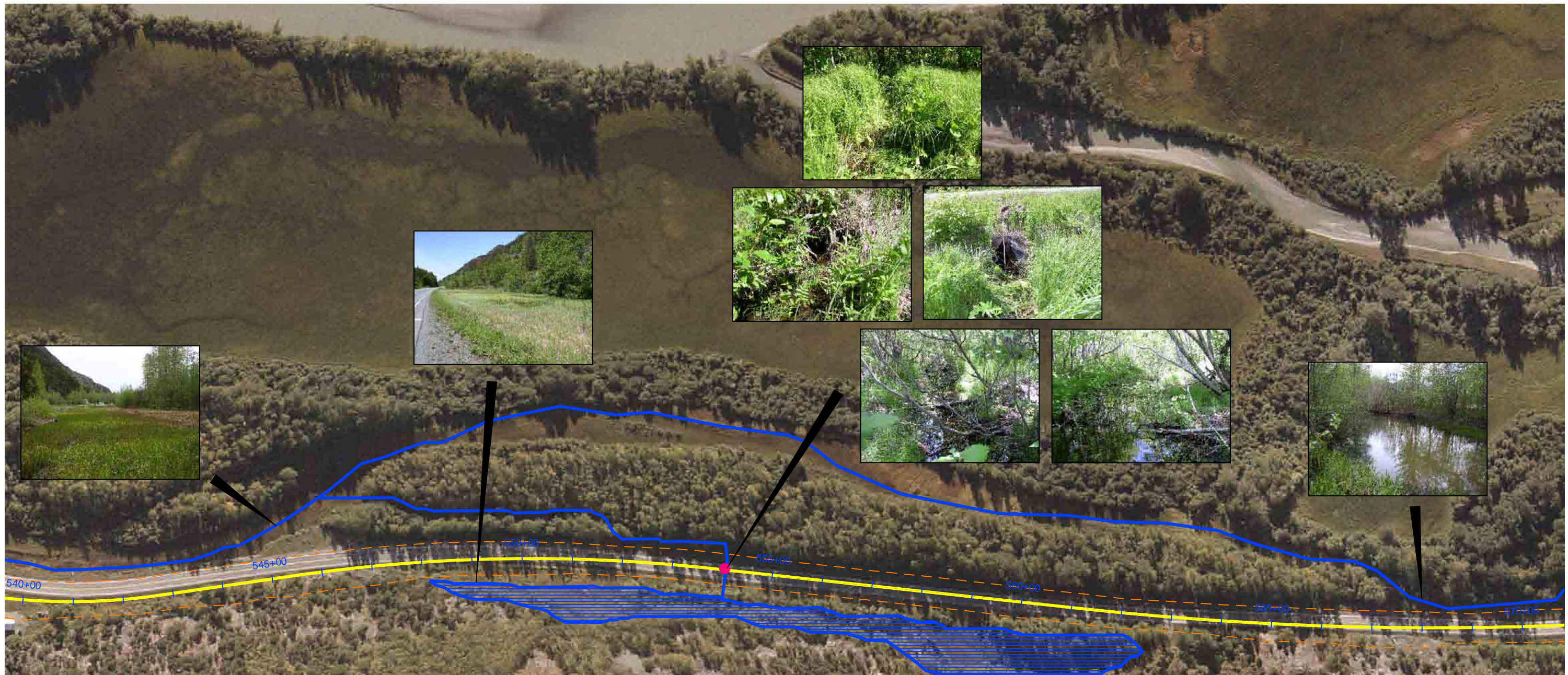

GENERAL NOTES:
 THE INITIAL STREAM SURVEY WAS CONDUCTED BETWEEN 10/4/05 AND 10/9/05, AND WAS UPDATED IN MAY AND JUNE 2006. THE STREAMS ARE ORGANIZED BY THE STATIONING OF THE HIGHWAY CROSSING CULVERT. WHERE POSSIBLE, THE STREAM HAS BEEN IDENTIFIED BY ITS ALASKA DEPARTMENT OF FISH AND GAME ANADROMOUS WATERS CATALOG (AWC) NUMBER. LISTED FISH USE INCORPORATES FIELD OBSERVATION, MAY 2006 TRAPPING RESULTS BY OHMP, AND AWC NOTES.

ALL AREAS OF THE CHILKAT RIVER ADJACENT TO THE HIGHWAY LIKELY SERVE AS MIGRATION AND REARING HABITAT FOR ALL FIVE SPECIES OF PACIFIC SALMON AS WELL AS DOLLY VARDEN, CUTTHROAT AND STEELHEAD. HABITAT FUNCTIONS NOTED ON THIS SHEET ARE IN ADDITION TO THESE USES.

TRIB STATION 548+00 TO 562+50
 CATALOG NUMBER: 115-32-10250-2028-0010
 STREAM NAME: 10 1/2 MILE POND
 FISH USE: COHO AND STEELHEAD REARING.
 DESCRIPTION: THIS IS AN ADF&G CATALOGUED POND ADJACENT TO THE ROAD ALONG THE BASE OF THE HILL SLOPE. THE WETLANDS DELINEATION REPORT CLASSIFIES THIS AREA AS "PALUSTRINE, SCRUB-SHRUB, BROAD LEAVED DECIDUOUS, PERMANENTLY FLOODED." THE CULVERT AT STATION 553+25 PROVIDES FISH ACCESS TO THIS POND. THE WATER LEVEL IN THIS POND IS PRIMARILY DETERMINED BY GROUNDWATER ELEVATION.

TRIB STATION 554+00
 CATALOG NUMBER: 115-32-10250-2028-0010 (POND IS CATALOGUED, STREAM NOT IDENTIFIED)
 STREAM NAME: 10 1/2 MILE POND, OUTLET STREAM
 FISH USE: COHO AND STEELHEAD REARING
 DESCRIPTION: ALTHOUGH THIS CREEK IS NOT SPECIFICALLY SHOWN ON THE ADF&G CATALOGUE MAPS, IT IS DIRECTLY CONNECTED TO THE 10 1/2 MILE POND. UPSTREAM OF THE CULVERT IS A 15' STREAM THAT THEN DISPERSES INTO THE POND. THE STREAM IS 2-3' WIDE AND 0.3' DEEP. STREAM SUBSTRATE IS ORGANIC, AND VEGETATION GROWS THROUGHOUT. BELOW THE CULVERT OUTLET THE STREAM RUNS FOR 6' IN A 2' WIDE, 0.2' DEEP CHANNEL, THEN DISPERSES INTO A 10-20' WIDE WETLAND FULL OF GRASSES AND WILLOWS. FLOW IN THIS WETLAND IS VISIBLE, DEPTH IS 0.8 TO 1.3'. THERE ARE SOME OPEN WATER AREAS. THIS WETLAND CONTINUES ALONG THE ROAD FOR ABOUT 175', THEN BECOMES MORE CHANNELIZED (3' WIDE, 0.3' DEEP) AND TURNS AWAY FROM THE ROAD. NEAR STATION 551+00 THE STREAM BROADENS TO 8-10' WIDE. MANY FISH WERE NOTED TO BE PRESENT (JUNE 2006).

TRIB STATION 528+50 TO 594+75
 CATALOG NUMBER: 115-32-10250-2028
 STREAM NAME: TEN MILE SLOUGH
 FISH USE: COHO, STEELHEAD AND DOLLY VARDEN REARING. PINK AND CHUM SALMON SPAWNING
 DESCRIPTION: THIS LONG SLOUGH FOLLOWS THE PATH OF A REMNANT CHILKAT RIVER CHANNEL AND IS FED PRIMARILY BY GROUNDWATER. THE LOWER END OF THE SLOUGH PROVIDES THE OUTLET CHANNEL FOR TEN MILE CREEK AND IS OFTEN BACKWATERED BY THE CHILKAT RIVER. THE LEVEL OF THE CHILKAT AND THE GROUNDWATER CONTROL THE WATER LEVEL IN THE SLOUGH. THIS SLOUGH IS CATALOGUED UP TO STATION 594+75. IN MAY OF 2006, WATER FLOW WAS VISIBLE THROUGHOUT THE LENGTH OF THE SLOUGH.

LEGEND
 ● S&HI CULVERT LOCATION

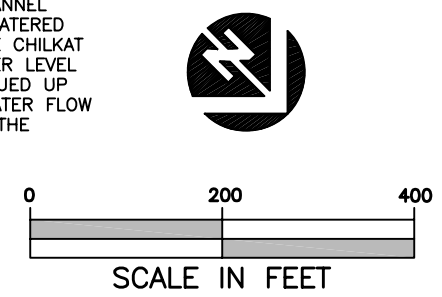

HAINES_BASE_SET.dwg

NO.	BY	DATE	REVISION	DESCRIPTION

RP	DM,GK,MS	DM,GK,MS
DRAWN	DESIGNED	CHECKED
DM,GK,MS	06/30/06	
APPROVED	DATE	PROJECT

State of Alaska Department of Transportation
 and Public Facilities - Haines, Alaska
 Haines Highway - MP 3.5 to 25.3

Prepared By:
 Inter-Fluve, Inc.
 1020 Wasco Street, Suite 1
 Hood River, OR 97031
 541.386.9003
 www.interfluve.com

Stream and Habitat Inventory
 Plan View: 540+00 to 570+00

SHEET
 13 of 36



GENERAL NOTES:
 THE INITIAL STREAM SURVEY WAS CONDUCTED BETWEEN 10/4/05 AND 10/9/05, AND WAS UPDATED IN MAY AND JUNE 2006. THE STREAMS ARE ORGANIZED BY THE STATIONING OF THE HIGHWAY CROSSING CULVERT. WHERE POSSIBLE, THE STREAM HAS BEEN IDENTIFIED BY ITS ALASKA DEPARTMENT OF FISH AND GAME ANADROMOUS WATERS CATALOG (AWC) NUMBER. LISTED FISH USE INCORPORATES FIELD OBSERVATION, MAY 2006 TRAPPING RESULTS BY OHMP, AND AWC NOTES.

TRIB STATION 579+50 TO 588+00

CATALOG NUMBER: 115-32-10250-2028-0020
 STREAM NAME: 11 MILE POND
 FISH USE: COHO AND STEELHEAD REARING.
 DESCRIPTION: THIS IS AN ADF&G CATALOGUED POND ADJACENT TO THE ROAD. THE WETLANDS DELINEATION REPORT CLASSIFIES THIS AREA AS "PALUSTRINE, EMERGENT, PERSISTENT, PERMANENTLY FLOODED." IT IS ASSUMED THAT A CULVERT PASSING THROUGH THE ACCESS ROAD SURROUNDING THIS POND PROVIDES FISH ACCESS FROM THE TEN MILE SLOUGH. THE MAXIMUM WATER DEPTH IN THIS POND IS WELL OVER THREE FEET. THE POND STAYS FLOODED THROUGHOUT THE YEAR, WITH WARM WATER UPWELLINGS MAINTAINING OPEN WATER HOLES DURING MODERATE WINTER CONDITIONS.

TRIB STATION 528+50 TO 594+75

CATALOG NUMBER: 115-32-10250-2028
 STREAM NAME: TEN MILE SLOUGH
 FISH USE: COHO, STEELHEAD AND DOLLY VARDEN REARING. PINK AND CHUM SALMON SPAWNING
 DESCRIPTION: THIS LONG SLOUGH FOLLOWS THE PATH OF A REMNANT CHILKAT RIVER CHANNEL AND IS FED PRIMARILY BY GROUNDWATER. THE LOWER END OF THE SLOUGH PROVIDES THE OUTLET CHANNEL FOR TEN MILE CREEK AND IS OFTEN BACKWATERED BY THE CHILKAT RIVER. THE LEVEL OF THE CHILKAT AND THE GROUNDWATER CONTROL THE WATER LEVEL IN THE SLOUGH. THIS SLOUGH IS CATALOGUED UP TO STATION 594+75. IN MAY OF 2006, WATER FLOW WAS VISIBLE THROUGHOUT THE LENGTH OF THE SLOUGH.

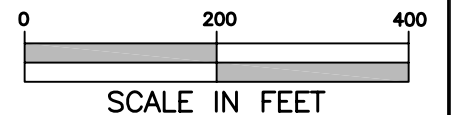

HAINES_BASE_SET.dwg

NO.	BY	DATE	REVISION	DESCRIPTION

RP	DM,GK,MS	DM,GK,MS
DRAWN	DESIGNED	CHECKED
DM,GK,MS	06/30/06	
APPROVED	DATE	PROJECT

State of Alaska Department of Transportation
 and Public Facilities – Haines, Alaska
 Haines Highway – MP 3.5 to 25.3

Prepared By:
 Inter-Fluve, Inc.

1020 Wasco Street, Suite 1
 Hood River, OR 97031
 541.386.9003
 www.interfluve.com

Stream and Habitat Inventory
 Plan View: 570+00 to 600+00

SHEET
 14 of 36



GENERAL NOTES:
 THE INITIAL STREAM SURVEY WAS CONDUCTED BETWEEN 10/4/05 AND 10/9/05, AND WAS UPDATED IN MAY AND JUNE 2006. THE STREAMS ARE ORGANIZED BY THE STATIONING OF THE HIGHWAY CROSSING CULVERT. WHERE POSSIBLE, THE STREAM HAS BEEN IDENTIFIED BY ITS ALASKA DEPARTMENT OF FISH AND GAME ANADROMOUS WATERS CATALOG (AWC) NUMBER. LISTED FISH USE INCORPORATES FIELD OBSERVATION, MAY 2006 TRAPPING RESULTS BY OHMP, AND AWC NOTES.



ALL AREAS OF THE CHILKAT RIVER ADJACENT TO THE HIGHWAY LIKELY SERVE AS MIGRATION AND REARING HABITAT FOR ALL FIVE SPECIES OF PACIFIC SALMON AS WELL AS DOLLY VARDEN, CUTTHROAT AND STEELHEAD. HABITAT FUNCTIONS NOTED ON THIS SHEET ARE IN ADDITION TO THESE USES.

BANK STATION 607+00
 TO 610+00

TRIB STATION 612+40

CATALOG NUMBER: 115-32-10250-2032
 STREAM NAME: 1 1/2 MILE CREEK
 FISH USE: REARING COHO, DOLLY VARDEN AND CUTTHROAT
 DESCRIPTION: UPSTREAM OF THE CULVERTS THE STREAM IS A 2' WIDE E TYPE CHANNEL WITH A VERY LOW GRADIENT. IT IS INFREQUENTLY BACKWATERED BY THE CHILKAT RIVER. THE BANKS ARE THICKLY VEGETATED WITH GRASSES AND THE SUBSTRATE IS A BLEND OF ORGANICS AND SILT. THE STREAM LEADS INTO A BROAD SWAMP, MEANDERING ALONG THE BACK OF THE SWAMP AND ENDING IN A WATERFALL AT STATION 629+50. DOWNSTREAM OF THE CULVERT THE STREAM BANKS ARE BARE SAND AND THE STREAM IS HEAVILY BACKWATERED BY THE RIVER. THE SUBSTRATE IS SILT/GRAVEL AND THERE IS NO COVER.

LEGEND

-  VEGETATED RIPRAP
-  S&HI CULVERT LOCATION

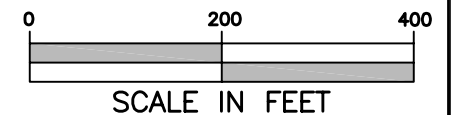

HAINES_BASE_SET.dwg

NO.	BY	DATE	REVISION	DESCRIPTION

RP	DM,GK,MS	DM,GK,MS
DRAWN	DESIGNED	CHECKED
DM,GK,MS	06/30/06	
APPROVED	DATE	PROJECT

State of Alaska Department of Transportation
 and Public Facilities – Haines, Alaska
 Haines Highway – MP 3.5 to 25.3

Prepared By:
 Inter-Fluve, Inc.

1020 Wasco Street, Suite 1
 Hood River, OR 97031
 541.386.9003
 www.interfluve.com

Stream and Habitat Inventory
 Plan View: 600+00 to 628+00

SHEET
 15 of 36



TRIB STATION 630+00

FISH USE: REARING CUTTHROAT AND DOLLY VARDEN
 DESCRIPTION: THE FLOOD OF NOVEMBER 2005 DIRECTED APPROXIMATELY TWO-THIRDS OF THE FLOW FROM THE WATERFALL AT STATION 629+50 TOWARDS THIS CULVERT. THE REST OF THE FLOW EXITS THROUGH THE CULVERT AT 612+40. ABOVE THE CULVERT INLET THE STREAM DIVIDES INTO A 6-8' WIDE, 1-2' DEEP RIFFLE, POOL, GLIDE COMPLEX RUNNING THROUGH AN ESTABLISHED ALDER AND BIRCH FOREST. THE STREAM SUBSTRATE IS SILT AND ORGANICS FOR THE FIRST 100', THEN CHANGES TO RECENTLY DEPOSITED ALLUVIAL MATERIAL. THE CULVERT EMPTIES DIRECTLY INTO THE CHILKAT RIVER AND IS PERCHED AT LOW WATER.

BANK STATION 631+50 TO 635+50

GENERAL NOTES:

THE INITIAL STREAM SURVEY WAS CONDUCTED BETWEEN 10/4/05 AND 10/9/05, AND WAS UPDATED IN MAY AND JUNE 2006. THE STREAMS ARE ORGANIZED BY THE STATIONING OF THE HIGHWAY CROSSING CULVERT. WHERE POSSIBLE, THE STREAM HAS BEEN IDENTIFIED BY ITS ALASKA DEPARTMENT OF FISH AND GAME ANADROMOUS WATERS CATALOG (AWC) NUMBER. LISTED FISH USE INCORPORATES FIELD OBSERVATION, MAY 2006 TRAPPING RESULTS BY OHMP, AND AWC NOTES.

ALL AREAS OF THE CHILKAT RIVER ADJACENT TO THE HIGHWAY LIKELY SERVE AS MIGRATION AND REARING HABITAT FOR ALL FIVE SPECIES OF PACIFIC SALMON AS WELL AS DOLLY VARDEN, CUTTHROAT AND STEELHEAD. HABITAT FUNCTIONS NOTED ON THIS SHEET ARE IN ADDITION TO THESE USES.

PROPOSED ACTION ALIGNMENT

LEGEND

-  VEGETATED RIPRAP
-  S&HI CULVERT LOCATION

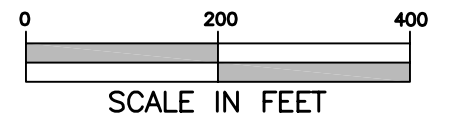

HAINES_BASE_SET.dwg

NO.	BY	DATE	REVISION DESCRIPTION

RP	DM,GK,MS	DM,GK,MS
DRAWN	DESIGNED	CHECKED
DM,GK,MS	06/30/06	
APPROVED	DATE	PROJECT

State of Alaska Department of Transportation
 and Public Facilities – Haines, Alaska
 Haines Highway – MP 3.5 to 25.3

Prepared By
 Inter-Fluve, Inc.

1020 Wasco Street, Suite 1
 Hood River, OR 97031
 541.386.9003
 www.interfluve.com

Stream and Habitat Inventory
 Plan View: 628+00 to 656+00

SHEET
 16 of 36

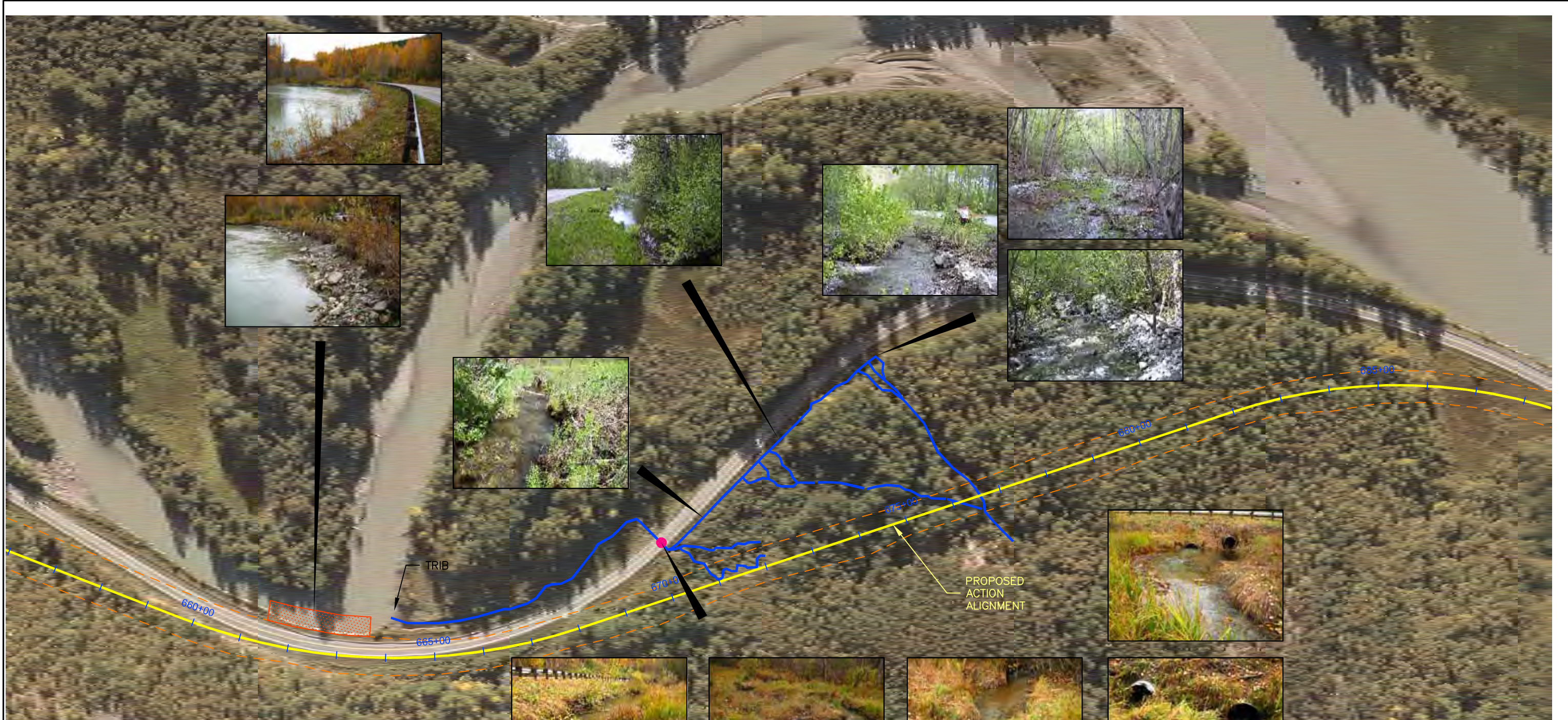

GENERAL NOTES:
 THE INITIAL STREAM SURVEY WAS CONDUCTED BETWEEN 10/4/05 AND 10/9/05, AND WAS UPDATED IN MAY AND JUNE 2006. THE STREAMS ARE ORGANIZED BY THE STATIONING OF THE HIGHWAY CROSSING CULVERT. WHERE POSSIBLE, THE STREAM HAS BEEN IDENTIFIED BY ITS ALASKA DEPARTMENT OF FISH AND GAME ANADROMOUS WATERS CATALOG (AWC) NUMBER. LISTED FISH USE INCORPORATES FIELD OBSERVATION, MAY 2006 TRAPPING RESULTS BY OHMP, AND AWC NOTES.

BANK STATION 661+50 TO 663+75:
ADULT SALMON HOLDING

TRIB STATION 670+00
 CATALOG NUMBER: 115-32-10250-2040
 STREAM NAME: 13 MILE CREEK
 FISH USE: REARING COHO, CHINOOK AND DOLLY VARDEN. SPAWNING CUTTHROAT AND PINK SALMON



LEGEND

- VEGETATED RIPRAP
- S&HI CULVERT LOCATION

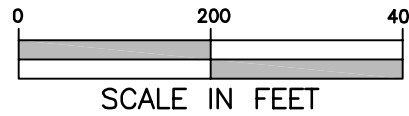

ALL AREAS OF THE CHILKAT RIVER ADJACENT TO THE HIGHWAY LIKELY SERVE AS MIGRATION AND REARING HABITAT FOR ALL FIVE SPECIES OF PACIFIC SALMON AS WELL AS DOLLY VARDEN, CUTTHROAT AND STEELHEAD. HABITAT FUNCTIONS NOTED ON THIS SHEET ARE IN ADDITION TO THESE USES.

DESCRIPTION: UPSTREAM OF THE CULVERTS THE STREAM SPLITS ALMOST IMMEDIATELY. THE EAST BRANCH BROADENS AND WINDS THROUGH ESTABLISHED FOREST. THIS BRANCH IS LOW BANKED, GRAVEL BOTTOMED, 2-3' WIDE AND 0.5' DEEP. IT SPLITS INTO TWO SEPARATE SPRING FED CHANNELS. THE MAIN BRANCH OF THE STREAM NOW FLOWS ALONG THE DITCHLINE OF ROAD BEFORE CUTTING UP THE FAN NEAR STATION 676+00. THE LOWER HALF OF THIS REACH HAS DEVELOPED INTO A 3-5' WIDE GRAVEL BOTTOMED CHANNEL WITH STABLE GRASSY BANKS. THE UPPER HALF OF THE REACH IS A NEW LOCATION FOR THE STREAM, AND A CHANNEL HAS YET TO BE FORMED. CURRENTLY THE STREAM FLOWS WIDE AND SHALLOW OVER GRASSES. AT THIS STATION, THE MAIN CHANNEL TURNS UPHILL FROM THE EXISTING ROAD AND RUNS THROUGH A NEWLY FORMED CHANNEL CARVED OUT OF ALLUVIAL MATERIAL DEPOSITED IN A MATURE FOREST. THE STREAM STEEPENS TO A CASCADE AND WATERFALL NEAR THE NEW ALIGNMENT. THE OLD STREAM CHANNEL HAS BEEN MOSTLY OBLITERATED BY THE RECENT FLOOD WITH FLOW GOING SUBSURFACE (DOTTED LINES) FOR MUCH OF THE LENGTH. THE CULVERTS EMPTY INTO A BROAD 15' BY 20' POOL THAT LEADS INTO A 4-8' WIDE E-CHANNEL BACKWATERED AT TIMES BY A BEAVER DAM AND THE INFLUENCE OF A SIDE CHANNEL OF THE RIVER. THE STREAM INTERSECTS THE RIVER NEAR STATION 664+25. THE STREAM BANKS ARE PREDOMINANTLY GRASS, WITH SOME WILLOW. AT TIMES, THE STREAM FLOWS DIRECTLY ALONG THE TOE OF THE ROAD FILL. THE LOWER SECTION OF THE STREAM IS MUCH LESS WELL VEGETATED THAT THE UPPER PORTION.

HAINES_BASE_SET.dwg

NO.	BY	DATE	REVISION	DESCRIPTION

RP	DM,GK,MS	DM,GK,MS
DRAWN	DESIGNED	CHECKED
DM,GK,MS	06/30/06	
APPROVED	DATE	PROJECT

State of Alaska Department of Transportation
 and Public Facilities - Haines, Alaska
 Haines Highway - MP 3.5 to 25.3

Prepared By:
 Inter-Fluve, Inc.
 1020 Wasco Street, Suite 1
 Hood River, OR 97031
 541.386.9003
 www.interfluve.com

Stream and Habitat Inventory
 Plan View: 656+00 to 688+00



LEGEND

 VEGETATED RIPRAP

GENERAL NOTES:
 THE INITIAL STREAM SURVEY WAS CONDUCTED BETWEEN 10/4/05 AND 10/9/05, AND WAS UPDATED IN MAY AND JUNE 2006. THE STREAMS ARE ORGANIZED BY THE STATIONING OF THE HIGHWAY CROSSING CULVERT. WHERE POSSIBLE, THE STREAM HAS BEEN IDENTIFIED BY ITS ALASKA DEPARTMENT OF FISH AND GAME ANADROMOUS WATERS CATALOG (AWC) NUMBER. LISTED FISH USE INCORPORATES FIELD OBSERVATION, MAY 2006 TRAPPING RESULTS BY OHMP, AND AWC NOTES.

ALL AREAS OF THE CHILKAT RIVER ADJACENT TO THE HIGHWAY LIKELY SERVE AS MIGRATION AND REARING HABITAT FOR ALL FIVE SPECIES OF PACIFIC SALMON AS WELL AS DOLLY VARDEN, CUTTHROAT AND STEELHEAD. HABITAT FUNCTIONS NOTED ON THIS SHEET ARE IN ADDITION TO THESE USES.

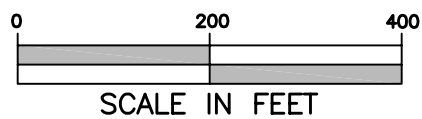

HAINES_BASE_SET.dwg

NO.	BY	DATE	REVISION DESCRIPTION

RP	DM,GK,MS	DM,GK,MS
DRAWN	DESIGNED	CHECKED
DM,GK,MS	06/30/06	PROJECT
APPROVED	DATE	

State of Alaska Department of Transportation
 and Public Facilities – Haines, Alaska
 Haines Highway – MP 3.5 to 25.3

Prepared By:
 Inter-Fluve, Inc.

1020 Wasco Street, Suite 1
 Hood River, OR 97031
 541.386.9003
 www.interfluve.com

Stream and Habitat Inventory
 Plan View: 688+00 to 720+00

SHEET

18 of 36

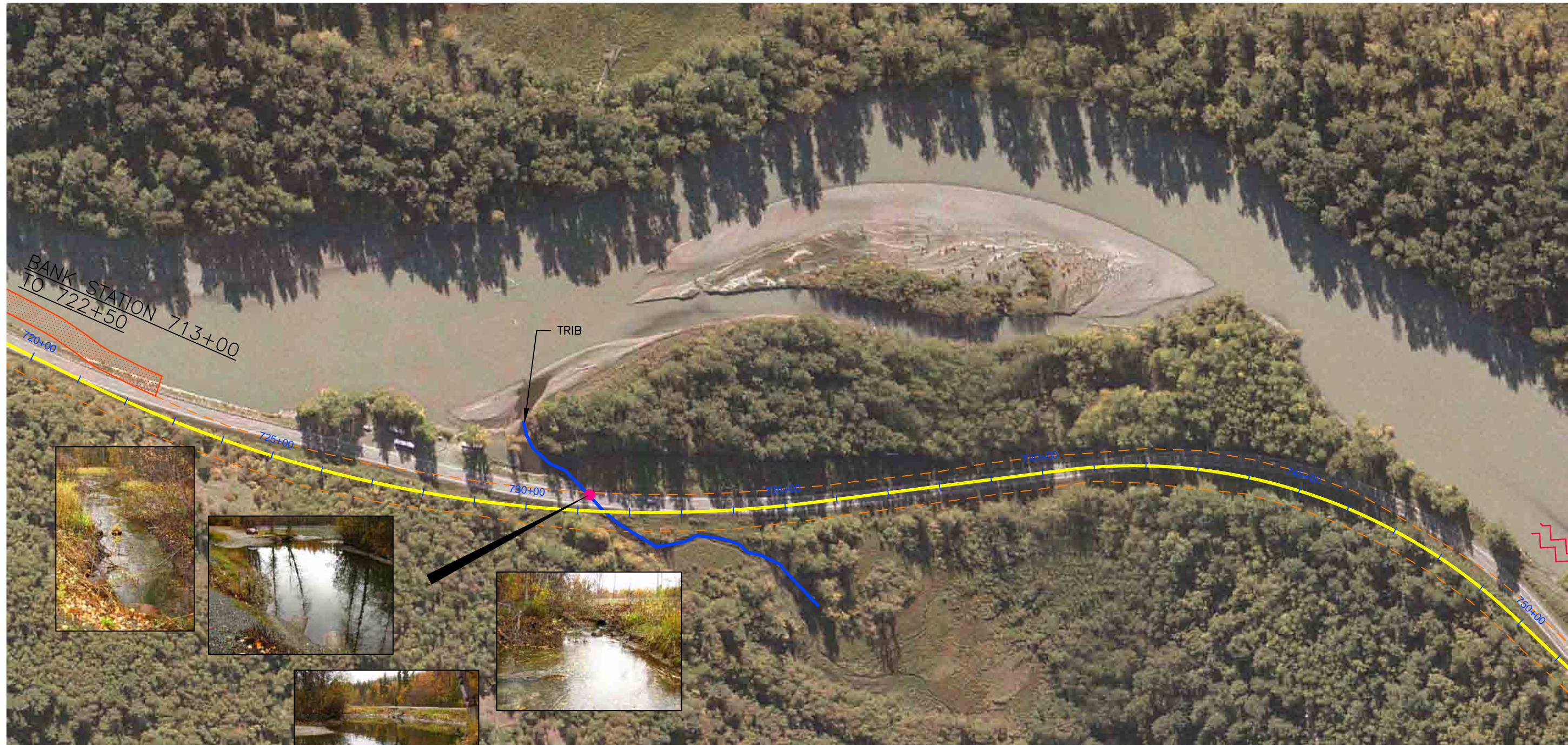

GENERAL NOTES:
 THE INITIAL STREAM SURVEY WAS CONDUCTED BETWEEN 10/4/05 AND 10/9/05, AND WAS UPDATED IN MAY AND JUNE 2006. THE STREAMS ARE ORGANIZED BY THE STATIONING OF THE HIGHWAY CROSSING CULVERT. WHERE POSSIBLE, THE STREAM HAS BEEN IDENTIFIED BY ITS ALASKA DEPARTMENT OF FISH AND GAME ANADROMOUS WATERS CATALOG (AWC) NUMBER. LISTED FISH USE INCORPORATES FIELD OBSERVATION, MAY 2006 TRAPPING RESULTS BY OHMP, AND AWC NOTES.

ALL AREAS OF THE CHILKAT RIVER ADJACENT TO THE HIGHWAY LIKELY SERVE AS MIGRATION AND REARING HABITAT FOR ALL FIVE SPECIES OF PACIFIC SALMON AS WELL AS DOLLY VARDEN, CUTTHROAT AND STEELHEAD. HABITAT FUNCTIONS NOTED ON THIS SHEET ARE IN ADDITION TO THESE USES.

STATION 731+00

CATALOG NUMBER: 115-32-10250-2044
 STREAM NAME: 14 MILE CREEK
 FISH USE: REARING AND SPAWNING COHO AND DOLLY VARDEN. REARING CHINOOK
 DESCRIPTION: UPSTREAM OF THE CULVERTS THE STREAM IS 8-10' WIDE AND LEADS INTO A VEGETATED MEADOW. STREAM BANKS ARE STABLE AND VEGETATED WITH GRASSES AND WILLOW. THE SUBSTRATE IS LOOSE SILT AND ORGANIC MATTER. THERE IS SOME BACKWATERING BY THE RIVER. THE OUTLETS OF THE CULVERTS ARE NEARLY SUBMERGED EVEN AT LOW RIVER LEVELS AND EMPTY INTO A LARGE, DEEP POOL THAT ACTS AS BOTH A REARING AREA FOR FISH AND A BOAT LAUNCH SITE. THE POOL EMPTIES INTO THE RIVER VIA A SHORT CHANNEL. THERE IS SOME OVERHANGING VEGETATION ON ONE SIDE OF THE POOL. SUBSTRATE IS SAND AND SILT.

LEGEND

-  VEGETATED RIPRAP
-  S&HI CULVERT LOCATION

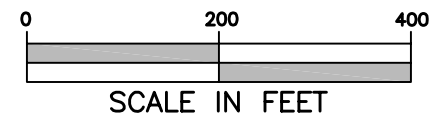

HAINES_BASE_SET.dwg

NO.	BY	DATE	REVISION	DESCRIPTION

RP	DM,GK,MS	DM,GK,MS
DRAWN	DESIGNED	CHECKED
DM,GK,MS	06/30/06	
APPROVED	DATE	PROJECT

State of Alaska Department of Transportation
 and Public Facilities – Haines, Alaska
 Haines Highway – MP 3.5 to 25.3

Prepared By:
 Inter-Fluve, Inc.
 1020 Wasco Street, Suite 1
 Hood River, OR 97031
 541.386.9003
 www.interfluve.com

Stream and Habitat Inventory
 Plan View: 720+00 to 750+00

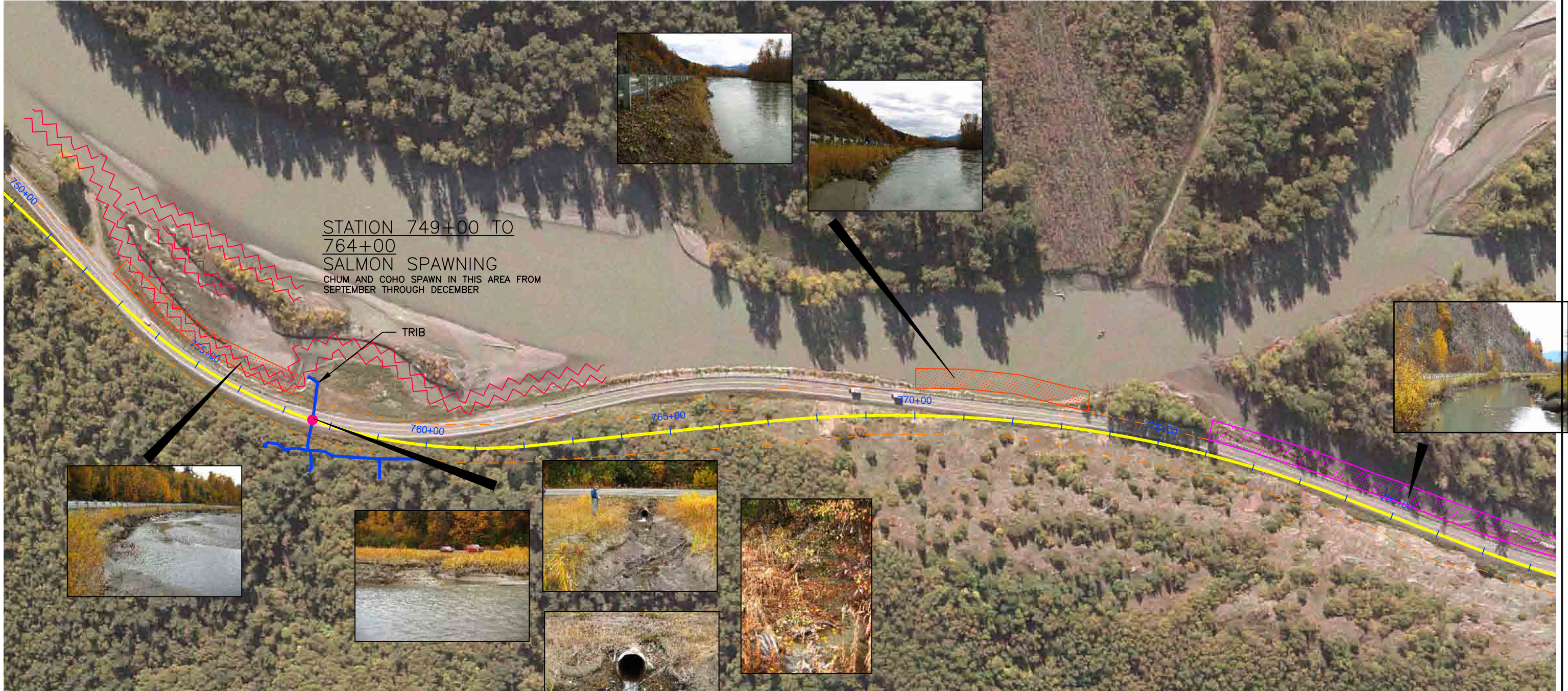

STATION 749+00 TO
764+00
SALMON SPAWNING
CHUM AND COHO SPAWN IN THIS AREA FROM
SEPTEMBER THROUGH DECEMBER

TRIB

BANK STATION 752+50
TO 757+00

BANK STATION 770+00
TO 773+50

BANK STATION 776+00
TO 788+75





TRIB STATION 757+50

FISH USE: REARING COHO, CHINOOK AND DOLLY VARDEN
DESCRIPTION: UPSTREAM OF THE CULVERT THERE IS A SMALL WATERFALL FED POOL THAT EXTENDS ABOUT 50' BACK ON LINE. THE STREAM BRANCH LEADING TO NORTH IS 5-8' WIDE AND 0.3' DEEP FOR THE FIRST 35', WHERE THE MAIN FLOW ENTERS AS A WATERFALL. THIS 35' RIFFLE SECTION IS SHALLOW, LITTERED WITH ORGANIC DEBRIS, AND HAS A GRAVEL SUBSTRATE. THE WATER EXTENDS IN A ROADSIDE DITCH UP TO STATION 759+00 WHERE THERE IS ANOTHER SMALL WATERFALL. THIS REACH IS AN 8' WIDE, 0.8' DEEP POOL. STANDING WATER WITH LITTLE FLOW EXTENDS ANOTHER 100' AHEAD ON LINE. FISH ARE PRESENT THROUGHOUT. DOWNSTREAM, THE PERCHED CULVERT EMPTIES INTO A SILTY CHANNEL BACKWATERED BY THE RIVER. GRASS GROWS ON THE BANKS ABOVE THE RIVER LEVEL, BUT BARE SILT IS EXPOSED LOWER DOWN. THERE IS NO COVER. THE RIVER GRAVEL BARS NEAR THE OUTLET ARE ACTIVELY USED FOR SPAWNING.

GENERAL NOTES:
THE INITIAL STREAM SURVEY WAS CONDUCTED BETWEEN 10/4/05 AND 10/9/05, AND WAS UPDATED IN MAY AND JUNE 2006. THE STREAMS ARE ORGANIZED BY THE STATIONING OF THE HIGHWAY CROSSING CULVERT. WHERE POSSIBLE, THE STREAM HAS BEEN IDENTIFIED BY ITS ALASKA DEPARTMENT OF FISH AND GAME ANADROMOUS WATERS CATALOG (AWC) NUMBER. LISTED FISH USE INCORPORATES FIELD OBSERVATION, MAY 2006 TRAPPING RESULTS BY OHMP, AND AWC NOTES.

ALL AREAS OF THE CHILKAT RIVER ADJACENT TO THE HIGHWAY LIKELY SERVE AS MIGRATION AND REARING HABITAT FOR ALL FIVE SPECIES OF PACIFIC SALMON AS WELL AS DOLLY VARDEN, CUTTHROAT AND STEELHEAD. HABITAT FUNCTIONS NOTED ON THIS SHEET ARE IN ADDITION TO THESE USES.

LEGEND

-  VEGETATED RIPRAP
-  HERBACEOUS SCRUB/SHRUB
-  S&HI CULVERT LOCATION
-  SPAWNING AREA

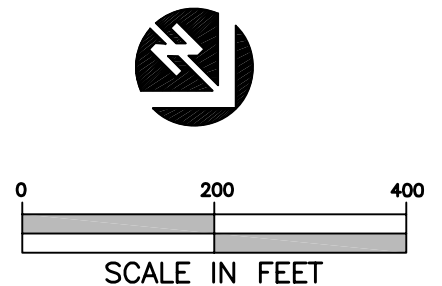

HAINES_BASE_SET.dwg

NO.	BY	DATE	REVISION	DESCRIPTION

RP	DM,GK,MS	DM,GK,MS
DRAWN	DESIGNED	CHECKED
DM,GK,MS	06/30/06	
APPROVED	DATE	PROJECT

State of Alaska Department of Transportation
and Public Facilities – Haines, Alaska
Haines Highway – MP 3.5 to 25.3

Prepared By:
Inter-Fluve, Inc.
1020 Wasco Street, Suite 1
Hood River, OR 97031
541.386.9003
www.interfluve.com

Stream and Habitat Inventory
Plan View: 750+00 to 783+00

SHEET
20 OF 36



BANK STATION 776+00
TO 788+75

GENERAL NOTES:
THE INITIAL STREAM SURVEY WAS CONDUCTED BETWEEN 10/4/05 AND 10/9/05, AND WAS UPDATED IN MAY AND JUNE 2006. THE STREAMS ARE ORGANIZED BY THE STATIONING OF THE HIGHWAY CROSSING CULVERT. WHERE POSSIBLE, THE STREAM HAS BEEN IDENTIFIED BY ITS ALASKA DEPARTMENT OF FISH AND GAME ANADROMOUS WATERS CATALOG (AWC) NUMBER. LISTED FISH USE INCORPORATES FIELD OBSERVATION, MAY 2006 TRAPPING RESULTS BY OHMP, AND AWC NOTES.



ALL AREAS OF THE CHILKAT RIVER ADJACENT TO THE HIGHWAY LIKELY SERVE AS MIGRATION AND REARING HABITAT FOR ALL FIVE SPECIES OF PACIFIC SALMON AS WELL AS DOLLY VARDEN, CUTTHROAT AND STEELHEAD. HABITAT FUNCTIONS NOTED ON THIS SHEET ARE IN ADDITION TO THESE USES.

TRIB STATION 788+00

FISH USE: REARING COHO, CHINOOK AND DOLLY VARDEN.
POSSIBLE REDD OBSERVED (OCTOBER 2005)
DESCRIPTION: THE CULVERT IS FED BY TWO MOUNTAIN STREAMS THAT JOIN TOGETHER ABOUT 20' UPSTREAM OF THE INLET. ONE OF THE STREAMS RUNS 100' BACK ON LINE IN A SHALLOW, 2-3' WIDE, GRAVEL BOTTOMED ROADSIDE DITCH WHICH ENDS IN A WATERFALL. THE SECOND BRANCH RUNS FOR A DISTANCE OF 120' AWAY FROM THE ROAD AND ALONG THE TOE OF THE MOUNTAIN BEFORE TURNING UPSLOPE AS A WATERFALL. THIS 120' OF STREAM IS COMPOSED OF 2-3' WIDE POOL/RIFFLE HABITAT WITH ROCK AND GRAVEL SUBSTRATE. IT IS WELL VEGETATED. THE CULVERT OUTLET EMPTIES DIRECTLY INTO THE RIVER.

BANK STATION 807+00
TO 811+75

LEGEND

-  HERBACEOUS SCRUB/SHRUB
-  S&H CULVERT LOCATION

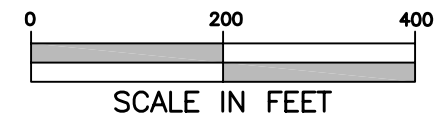

HAINES_BASE_SET.dwg

NO.	BY	DATE	REVISION	DESCRIPTION

RP	DM,GK,MS	DM,GK,MS
DRAWN	DESIGNED	CHECKED
DM,GK,MS	06/30/06	
APPROVED	DATE	PROJECT

State of Alaska Department of Transportation
and Public Facilities – Haines, Alaska
Haines Highway – MP 3.5 to 25.3

Prepared By:
Inter-Fluve, Inc.
1020 Wasco Street, Suite 1
Hood River, OR 97031
541.386.9003
www.interfluve.com

Stream and Habitat Inventory
Plan View: 783+00 to 813+00



GENERAL NOTES:
 THE INITIAL STREAM SURVEY WAS CONDUCTED BETWEEN 10/4/05 AND 10/9/05, AND WAS UPDATED IN MAY AND JUNE 2006. THE STREAMS ARE ORGANIZED BY THE STATIONING OF THE HIGHWAY CROSSING CULVERT. WHERE POSSIBLE, THE STREAM HAS BEEN IDENTIFIED BY ITS ALASKA DEPARTMENT OF FISH AND GAME ANADROMOUS WATERS CATALOG (AWC) NUMBER. LISTED FISH USE INCORPORATES FIELD OBSERVATION, MAY 2006 TRAPPING RESULTS BY OHMP, AND AWC NOTES.

ALL AREAS OF THE CHILKAT RIVER ADJACENT TO THE HIGHWAY LIKELY SERVE AS MIGRATION AND REARING HABITAT FOR ALL FIVE SPECIES OF PACIFIC SALMON AS WELL AS DOLLY VARDEN, CUTTHROAT AND STEELHEAD. HABITAT FUNCTIONS NOTED ON THIS SHEET ARE IN ADDITION TO THESE USES.

BANK STATION 837+00
TO 838+50:
 SALMON HOLDING

LEGEND

 VEGETATED RIPRAP



HAINES_BASE_SET.dwg

NO.	BY	DATE	REVISION	DESCRIPTION

RP	DM,GK,MS	DM,GK,MS
DRAWN	DESIGNED	CHECKED
DM,GK,MS	06/30/06	
APPROVED	DATE	PROJECT

State of Alaska Department of Transportation
 and Public Facilities – Haines, Alaska
 Haines Highway – MP 3.5 to 25.3

Prepared By:
 Inter-Fluve, Inc.
 1020 Wasco Street, Suite 1
 Hood River, OR 97031
 541.386.9003
 www.interfluve.com

Stream and Habitat Inventory
 Plan View: 813+00 to 843+00

SHEET
 22 of 36



BANK STATION 850+00
TO 851+75:
 SALMON HOLDING

GENERAL NOTES:

THE INITIAL STREAM SURVEY WAS CONDUCTED BETWEEN 10/4/05 AND 10/9/05, AND WAS UPDATED IN MAY AND JUNE 2006. THE STREAMS ARE ORGANIZED BY THE STATIONING OF THE HIGHWAY CROSSING CULVERT. WHERE POSSIBLE, THE STREAM HAS BEEN IDENTIFIED BY ITS ALASKA DEPARTMENT OF FISH AND GAME ANADROMOUS WATERS CATALOG (AWC) NUMBER. LISTED FISH USE INCORPORATES FIELD OBSERVATION, MAY 2006 TRAPPING RESULTS BY OHMP, AND AWC NOTES.

ALL AREAS OF THE CHILKAT RIVER ADJACENT TO THE HIGHWAY LIKELY SERVE AS MIGRATION AND REARING HABITAT FOR ALL FIVE SPECIES OF PACIFIC SALMON AS WELL AS DOLLY VARDEN, CUTTHROAT AND STEELHEAD. HABITAT FUNCTIONS NOTED ON THIS SHEET ARE IN ADDITION TO THESE USES.

LEGEND

 VEGETATED RIPRAP

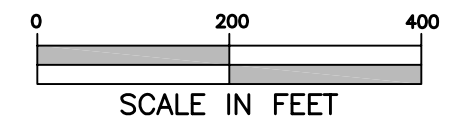

HAINES_BASE_SET.dwg

NO.	BY	DATE	REVISION	DESCRIPTION

RP	DM,GK,MS	DM,GK,MS
DRAWN	DESIGNED	CHECKED
DM,GK,MS	06/30/06	
APPROVED	DATE	PROJECT

State of Alaska Department of Transportation
 and Public Facilities – Haines, Alaska
 Haines Highway – MP 3.5 to 25.3

Prepared By:
 Inter-Fluve, Inc.

1020 Wasco Street, Suite 1
 Hood River, OR 97031
 541.386.9003
 www.interfluve.com

Stream and Habitat Inventory
 Plan View: 843+00 to 873+00

SHEET
 23 of 36

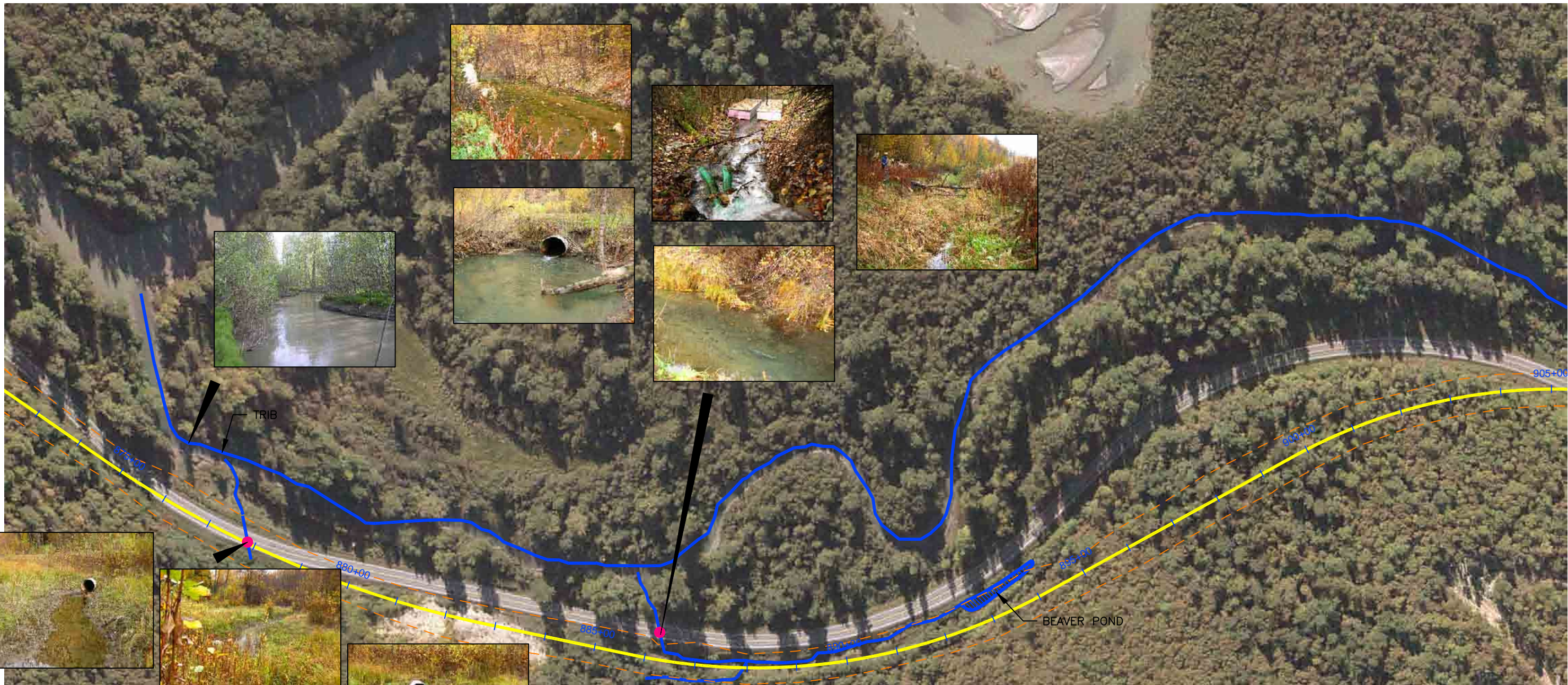

GENERAL NOTES:
 THE INITIAL STREAM SURVEY WAS CONDUCTED BETWEEN 10/4/05 AND 10/9/05, AND WAS UPDATED IN MAY AND JUNE 2006. THE STREAMS ARE ORGANIZED BY THE STATIONING OF THE HIGHWAY CROSSING CULVERT. WHERE POSSIBLE, THE STREAM HAS BEEN IDENTIFIED BY ITS ALASKA DEPARTMENT OF FISH AND GAME ANADROMOUS WATERS CATALOG (AWC) NUMBER. LISTED FISH USE INCORPORATES FIELD OBSERVATION, MAY 2006 TRAPPING RESULTS BY OHMP, AND AWC NOTES.

TRIB STATION 877+90

FISH USE: REARING COHO AND DOLLY VARDEN
 DESCRIPTION: UPSTREAM OF THE CULVERT THERE IS NO VISIBLE STREAM CHANNEL, ONLY A COLLECTION POOL THAT DRAINS SMALL ADJACENT SEEPAGES. THE CULVERT EMPTIES INTO A SILTY BACKWATERED CHANNEL WITH LITTLE COVER. THIS 4' WIDE, 6" DEEP CHANNEL LEADS TO A SIDE BRANCH OF WATER.

STATION 873+00 TO 910+00 AND AHEAD

CATALOG NUMBER: 115-32-10250-2060
 STREAM NAME: EIGHTEEN MILE SLOUGH
 FISH USE: COHO AND CHUM REARING. COHO AND CHUM SALMON SPAWNING. PINK SALMON PRESENCE.
 DESCRIPTION: THIS LONG SLOUGH IS FLOODED BY THE CHILKAT RIVER DURING PERIODS OF HIGH WATER, BUT IS SPRING FED AND RUNS CLEAR DURING LOW WATER. THE UPPER REACHES OF THE SLOUGH ARE HEAVILY UTILIZED BY SPAWNING CHUM AND COHO SALMON BUT, FOR ADULT SALMON, THE REACH BETWEEN 873+00 AND 910+00 SERVES PRIMARILY AS A PASSAGE. SLOUGH SUBSTRATE IN THIS REACH APPEARS TO BE PRIMARILY SILT. REARING FISH ARE LIKELY FOUND THROUGHOUT THE LENGTH OF THE SLOUGH. NEAR STATION 875+00 THE SLOUGH IS 40-50' WIDE, AND NARROWS TO APPROXIMATELY 30' WIDE NEAR STATION 910+00. THE SLOUGH BANKS ARE FORESTED.

STATION 886+00

CATALOG NUMBER: 115-32-10250-2060-3002
 FISH USE: REARING COHO, CHINOOK AND DOLLY VARDEN. SPAWNING CHUM AND COHO
 DESCRIPTION: THE STREAM UPSTREAM OF THE CULVERT IS A MAN-MADE COMPLEX CONSISTING OF TWO DISTINCT BRANCHES. THE MAIN BRANCH IS A SPRING FED CHANNEL THAT RUNS UP TO STATION 893+50 WHERE IT ENDS IN A BEAVER DAM OR MAN-MADE BERM. THE LOWER HALF OF THIS CHANNEL IS CONSISTENTLY 8-10' WIDE AND FORMS A SLOW MOVING POOL 1-2' DEEP. THE STEEP BANKS ARE VEGETATED WITH OVERHANGING GRASSES. SEVERAL SPRINGS FEED INTO THE CHANNEL FROM UNDER THE BANK ON THE MOUNTAIN SIDE. THE UPPER HALF OF THE CHANNEL IS A 2-3' WIDE RIFFLE WINDING THROUGH BOULDERS AND THICKLY VEGETATED WITH GRASSES. THE SECOND BRANCH OF THE COMPLEX FEEDS INTO THE MAIN BRANCH ABOUT 100' UPSTREAM OF THE CULVERT INLET. THIS BRANCH IS FED BY A SERIES OF SPRINGS, AS WELL AS A MOUNTAIN STREAM, AND RISES IN A SERIES OF POOLS AND RIFFLES UP TO A CHUM SALMON INCUBATION BOX FACILITY OPERATED BY THE NORTHERN SOUTHEAST REGIONAL AQUACULTURE ASSOCIATION. THE STREAM SUBSTRATE IS GRAVEL/COBBLE AND THE BANKS ARE WELL VEGETATED. DOWNSTREAM THE CULVERT OUTLET EMPTIES INTO A LARGE POOL USED AS A HOLDING AREA FOR ADULT CHUM SALMON. POOL SUBSTRATE IS SILT COVERED GRAVEL. A SHORT CHANNEL CONNECTS THE POOL TO THE CHILKAT RIVER.

LEGEND

● S&HI CULVERT LOCATION

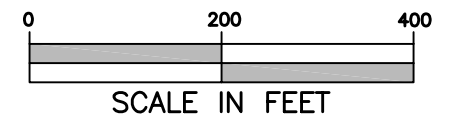

HAINES_BASE_SET.dwg

NO.	BY	DATE	REVISION	DESCRIPTION

RP	DM,GK,MS	DM,GK,MS
DRAWN	DESIGNED	CHECKED
DM,GK,MS	06/30/06	
APPROVED	DATE	PROJECT

State of Alaska Department of Transportation
 and Public Facilities - Haines, Alaska
 Haines Highway - MP 3.5 to 25.3

Prepared By:
 Inter-Fluve, Inc.
 1020 Wasco Street, Suite 1
 Hood River, OR 97031
 541.386.9003
 www.interfluve.com

Stream and Habitat Inventory
 Plan View: 873+00 to 905+00

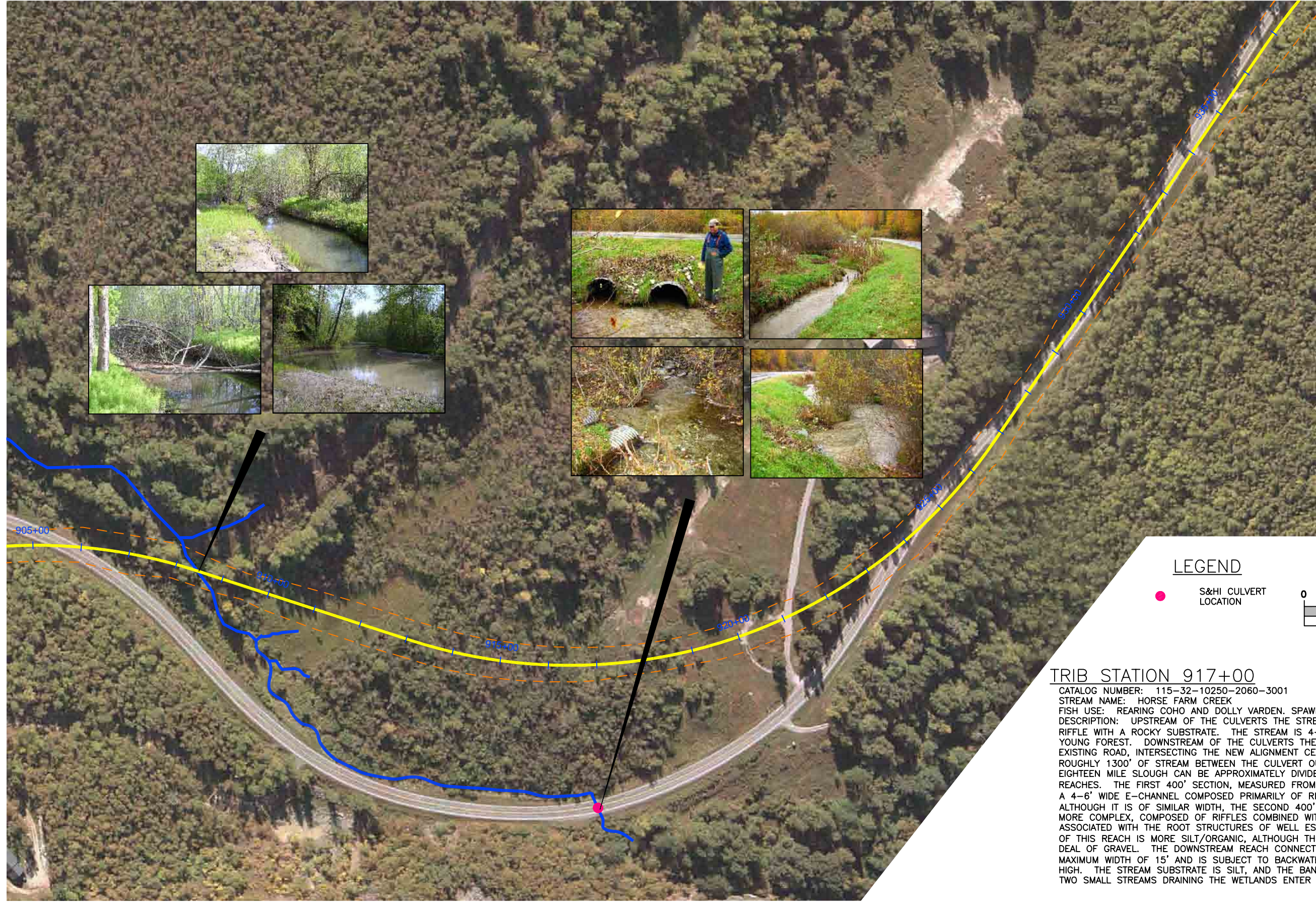

GENERAL NOTES:
 THE INITIAL STREAM SURVEY WAS CONDUCTED BETWEEN 10/4/05 AND 10/9/05, AND WAS UPDATED IN MAY AND JUNE 2006. THE STREAMS ARE ORGANIZED BY THE STATIONING OF THE HIGHWAY CROSSING CULVERT. WHERE POSSIBLE, THE STREAM HAS BEEN IDENTIFIED BY ITS ALASKA DEPARTMENT OF FISH AND GAME ANADROMOUS WATERS CATALOG (AWC) NUMBER. LISTED FISH USE INCORPORATES FIELD OBSERVATION, MAY 2006 TRAPPING RESULTS BY OHMP, AND AWC NOTES.

ALL AREAS OF THE CHILKAT RIVER ADJACENT TO THE HIGHWAY LIKELY SERVE AS MIGRATION AND REARING HABITAT FOR ALL FIVE SPECIES OF PACIFIC SALMON AS WELL AS DOLLY VARDEN, CUTTHROAT AND STEELHEAD. HABITAT FUNCTIONS NOTED ON THIS SHEET ARE IN ADDITION TO THESE USES.

STATION 873+00
 TO 910+00 AND
 AHEAD

CATALOG NUMBER:
 115-32-10250-2060
 STREAM NAME: EIGHTEEN MILE
 SLOUGH. SEE SHEET 24



LEGEND

● S&HI CULVERT LOCATION

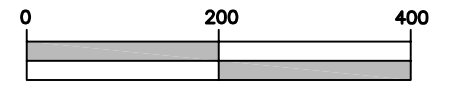

SCALE IN FEET

TRIB STATION 917+00

CATALOG NUMBER: 115-32-10250-2060-3001
 STREAM NAME: HORSE FARM CREEK
 FISH USE: REARING COHO AND DOLLY VARDEN. SPAWNING PINK AND COHO
 DESCRIPTION: UPSTREAM OF THE CULVERTS THE STREAM IS A FAST 4-6% CONTINUOUS RIFFLE WITH A ROCKY SUBSTRATE. THE STREAM IS 4-6' WIDE AND MEANDERS THROUGH A YOUNG FOREST. DOWNSTREAM OF THE CULVERTS THE STREAM MEANDERS ALONG THE EXISTING ROAD, INTERSECTING THE NEW ALIGNMENT CENTERLINE AT STATION 908+50. THE ROUGHLY 1300' OF STREAM BETWEEN THE CULVERT OUTLET AND THE CONFLUENCE WITH EIGHTEEN MILE SLOUGH CAN BE APPROXIMATELY DIVIDED BY HABITAT TYPE INTO THREE REACHES. THE FIRST 400' SECTION, MEASURED FROM THE CULVERT OUTLET DOWNSTREAM, IS A 4-6' WIDE E-CHANNEL COMPOSED PRIMARILY OF RIFFLES, WITH A SUBSTRATE OF GRAVEL. ALTHOUGH IT IS OF SIMILAR WIDTH, THE SECOND 400' SECTION IS FLATTER IN GRADIENT AND MORE COMPLEX, COMPOSED OF RIFFLES COMBINED WITH NUMEROUS DEEP POOLS ASSOCIATED WITH THE ROOT STRUCTURES OF WELL ESTABLISHED VEGETATION. THE SUBSTRATE OF THIS REACH IS MORE SILT/ORGANIC, ALTHOUGH THE 11/06 FLOOD DID DEPOSIT A GOOD DEAL OF GRAVEL. THE DOWNSTREAM REACH CONNECTING TO THE SLOUGH WIDENS TO A MAXIMUM WIDTH OF 15' AND IS SUBJECT TO BACKWATERING WHEN THE CHILKAT RIVER IS HIGH. THE STREAM SUBSTRATE IS SILT, AND THE BANKS ARE STEEP AND WELL VEGETATED. TWO SMALL STREAMS DRAINING THE WETLANDS ENTER HORSE FARM CREEK FROM THE WEST.

HAINES_BASE_SET.dwg

NO.	BY	DATE	REVISION	DESCRIPTION

RP	DM,GK,MS	DM,GK,MS
DRAWN	DESIGNED	CHECKED
DM,GK,MS	06/30/06	
APPROVED	DATE	PROJECT

State of Alaska Department of Transportation
 and Public Facilities - Haines, Alaska
 Haines Highway - MP 3.5 to 25.3

Prepared By:
 Inter-Fluve, Inc.

1020 Wasco Street, Suite 1
 Hood River, OR 97031
 541.386.9003
 www.interfluve.com

Stream and Habitat Inventory
 Plan View: 905+00 to 937+00

SHEET
 25 of 36



GENERAL NOTES:
 THE INITIAL STREAM SURVEY WAS CONDUCTED BETWEEN 10/4/05 AND 10/9/05, AND WAS UPDATED IN MAY AND JUNE 2006. THE STREAMS ARE ORGANIZED BY THE STATIONING OF THE HIGHWAY CROSSING CULVERT. WHERE POSSIBLE, THE STREAM HAS BEEN IDENTIFIED BY ITS ALASKA DEPARTMENT OF FISH AND GAME ANADROMOUS WATERS CATALOG (AWC) NUMBER. LISTED FISH USE INCORPORATES FIELD OBSERVATION, MAY 2006 TRAPPING RESULTS BY OHMP, AND AWC NOTES.

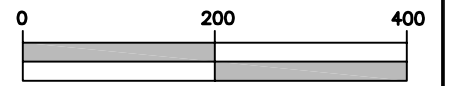

SCALE IN FEET

HAINES_BASE_SET.dwg

NO.	BY	DATE	REVISION	DESCRIPTION

RP	DM,GK,MS	DM,GK,MS
DRAWN	DESIGNED	CHECKED
DM,GK,MS	06/30/06	
APPROVED	DATE	PROJECT

State of Alaska Department of Transportation
 and Public Facilities – Haines, Alaska
 Haines Highway – MP 3.5 to 25.3

Prepared By:
 Inter-Fluve, Inc.

1020 Wasco Street, Suite 1
 Hood River, OR 97031
 541.386.9003
 www.interfluve.com

Stream and Habitat Inventory
 Plan View: 937+00 to 970+00

SHEET
 26 of 36

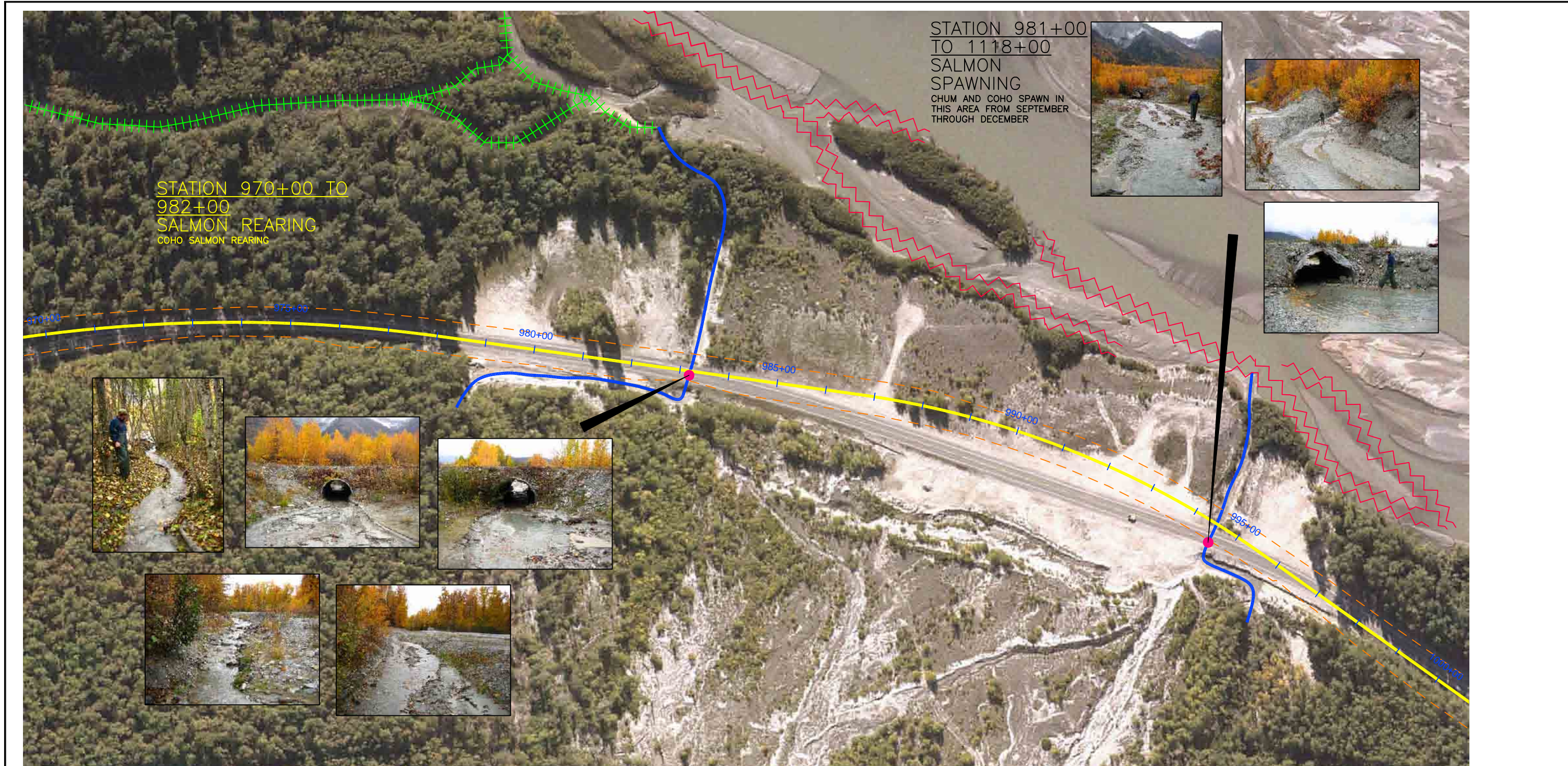

STATION 981+00
TO 1118+00
SALMON
SPAWNING
CHUM AND COHO SPAWN IN
THIS AREA FROM SEPTEMBER
THROUGH DECEMBER

STATION 970+00 TO
982+00
SALMON REARING
COHO SALMON REARING

TRIB STATION 983+25

FISH USE: REARING COHO AND DOLLY VARDEN
DESCRIPTION: THIS STREAM IS PART OF THE 19 MILE SLIDE AREA AND IS SUBJECT TO ALTERATION BY THE PERIODIC INFLUX AND MECHANICAL REMOVAL OF LARGE QUANTITIES OF SLIDE MATERIAL. THIS MATERIAL CONSISTS OF FINE DECOMPOSED ROCK AND GRAVELS MIXED WITH COBBLES. THE STREAM ABOVE THE CULVERT RUNS IN AN OPEN DITCH ALONG THE ROAD BACK TO STATION 979+00. NO VEGETATION IS PRESENT YET NUMEROUS JUVENILE FISH WERE SEEN IN THE STREAM (OCTOBER 2005). THE STREAM TURNS AWAY FROM THE ROAD AND RUNS TOWARD THE MOUNTAIN FOR ABOUT 75' BEFORE ANY UPSTREAM MOVEMENT OF FISH IS PREVENTED BY A BARRIER FALLS. DOWNSTREAM OF THE CULVERT THE STREAM IS BRAIDED AND OPEN UNTIL IT INTERSECTS THE WOODS SEVERAL HUNDRED FEET BELOW THE PIPE. THE SUBSTRATE IS SLIDE MATERIAL AND INITIALLY THERE IS LITTLE VEGETATION. ONCE THE STREAM ENTERS THE WOODS IT IS A 2-3' WIDE FAST RIFFLE UNTIL IT EMPTIES INTO A SERIES OF RIVERSIDE POOLS FED BY UPWELLING WATER.

TRIB STATION 994+50

FISH USE: UNKNOWN
DESCRIPTION: THE STREAM ABOVE THE CULVERT OF THIS 19 MILE SLIDE STREAM IS VERY UNSTABLE AND OFTEN EXCAVATED BY HEAVY EQUIPMENT. SUBSTRATE IS MOBILE SLIDE MATERIAL. SOME VEGETATION IS BEGINNING TO BE ESTABLISHED ON THE BANKS. FISH PASSAGE ABOVE THE CULVERT IS BLOCKED BY A HEADCUT UPSTREAM 200'. DOWNSTREAM OF THE CULVERT THE STREAM IS INITIALLY A BRAIDED RIFFLE WITH LITTLE SIGN OF VIABLE FISH HABITAT. TWO HUNDRED FEET DOWNSTREAM OF THE CULVERT OUTLET THE STREAM BECOMES A STEEP CASCADE THROUGH BOULDERS UNTIL IT ENTERS THE RIVER.

LEGEND

- S&HI CULVERT LOCATION
- ~ SPAWNING AREA
- - - - - REARING

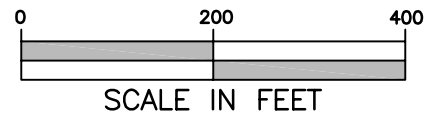

GENERAL NOTES:
THE INITIAL STREAM SURVEY WAS CONDUCTED BETWEEN 10/4/05 AND 10/9/05, AND WAS UPDATED IN MAY AND JUNE 2006. THE STREAMS ARE ORGANIZED BY THE STATIONING OF THE HIGHWAY CROSSING CULVERT. WHERE POSSIBLE, THE STREAM HAS BEEN IDENTIFIED BY ITS ALASKA DEPARTMENT OF FISH AND GAME ANADROMOUS WATERS CATALOG (AWC) NUMBER. LISTED FISH USE INCORPORATES FIELD OBSERVATION, MAY 2006 TRAPPING RESULTS BY OHMP, AND AWC NOTES.

ALL AREAS OF THE CHILKAT RIVER ADJACENT TO THE HIGHWAY LIKELY SERVE AS MIGRATION AND REARING HABITAT FOR ALL FIVE SPECIES OF PACIFIC SALMON AS WELL AS DOLLY VARDEN, CUTTHROAT AND STEELHEAD. SOME SPECIFIC REARING LOCATIONS HAVE BEEN IDENTIFIED. OTHER HABITAT FUNCTIONS NOTED ON THIS SHEET ARE IN ADDITION TO THESE USES.

HAINES_BASE_SET.dwg

NO.	BY	DATE	REVISION	DESCRIPTION

RP	DM,GK,MS	DM,GK,MS
DRAWN	DESIGNED	CHECKED
DM,GK,MS	06/30/06	PROJECT
APPROVED	DATE	

State of Alaska Department of Transportation
and Public Facilities – Haines, Alaska
Haines Highway – MP 3.5 to 25.3

Prepared By:
Inter-Fluve, Inc.
1020 Wasco Street, Suite 1
Hood River, OR 97031
541.386.9003
www.interfluve.com

Stream and Habitat Inventory
Plan View: 970+00 to 1000+00
SHEET
27 of 36

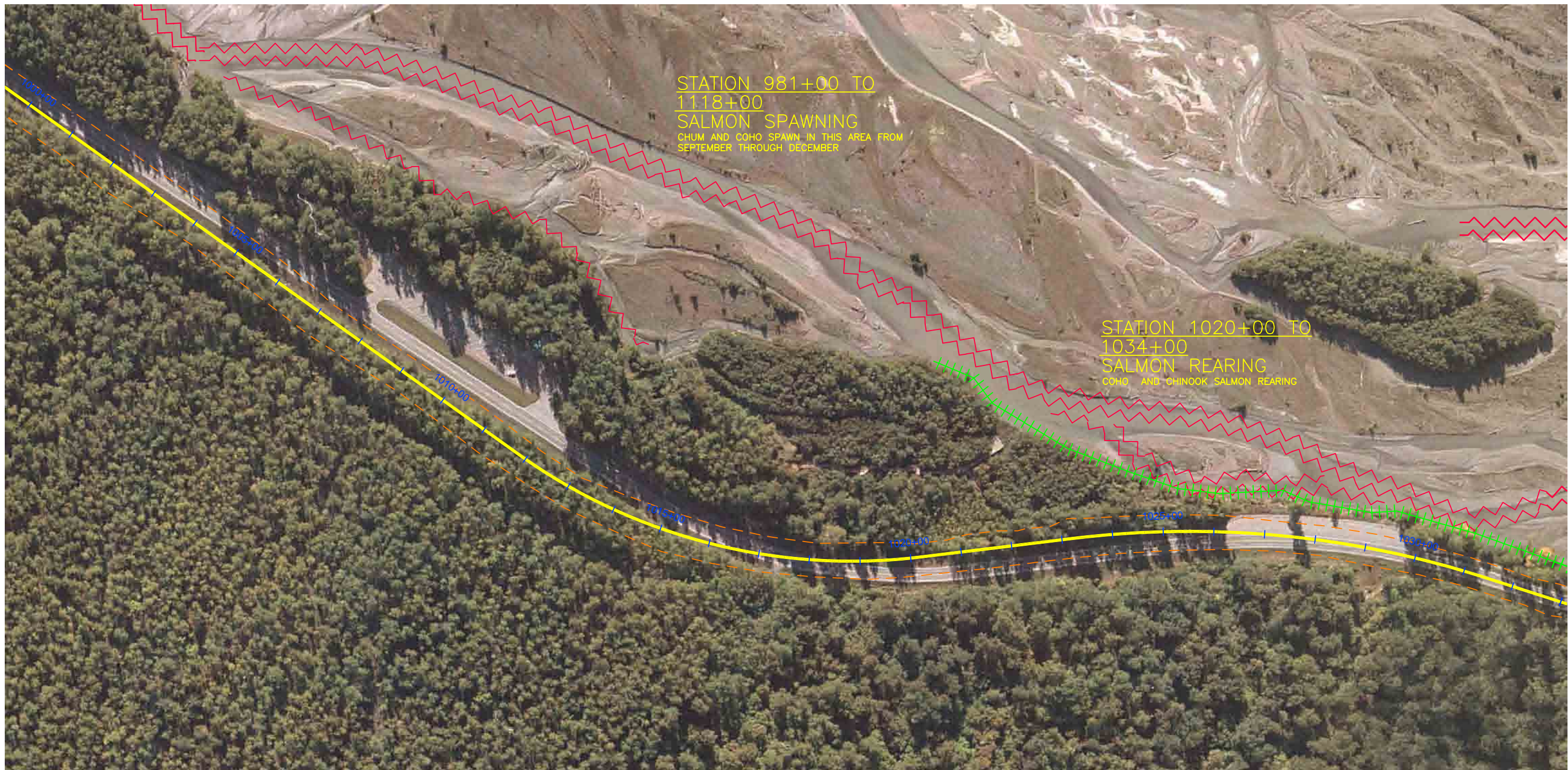

STATION 981+00 TO
1118+00
SALMON SPAWNING
CHUM AND COHO SPAWN IN THIS AREA FROM
SEPTEMBER THROUGH DECEMBER

STATION 1020+00 TO
1034+00
SALMON REARING
COHO AND CHINOOK SALMON REARING

GENERAL NOTES:
THE INITIAL STREAM SURVEY WAS CONDUCTED BETWEEN 10/4/05 AND 10/9/05, AND WAS UPDATED IN MAY AND JUNE 2006. THE STREAMS ARE ORGANIZED BY THE STATIONING OF THE HIGHWAY CROSSING CULVERT. WHERE POSSIBLE, THE STREAM HAS BEEN IDENTIFIED BY ITS ALASKA DEPARTMENT OF FISH AND GAME ANADROMOUS WATERS CATALOG (AWC) NUMBER. LISTED FISH USE INCORPORATES FIELD OBSERVATION, MAY 2006 TRAPPING RESULTS BY OHMP, AND AWC NOTES.

ALL AREAS OF THE CHILKAT RIVER ADJACENT TO THE HIGHWAY LIKELY SERVE AS MIGRATION AND REARING HABITAT FOR ALL FIVE SPECIES OF PACIFIC SALMON AS WELL AS DOLLY VARDEN, CUTTHROAT AND STEELHEAD. SOME SPECIFIC REARING LOCATIONS HAVE BEEN IDENTIFIED. OTHER HABITAT FUNCTIONS NOTED ON THIS SHEET ARE IN ADDITION TO THESE USES.



LEGEND

- SPAWNING AREA
- REARING

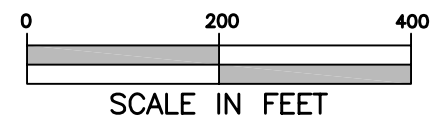

HAINES_BASE_SET.dwg

NO.	BY	DATE	REVISION DESCRIPTION

RP	DM,GK,MS	DM,GK,MS
DRAWN	DESIGNED	CHECKED
DM,GK,MS	06/30/06	
APPROVED	DATE	PROJECT

State of Alaska Department of Transportation
and Public Facilities – Haines, Alaska
Haines Highway – MP 3.5 to 25.3

Prepared By:
Inter-Fluve, Inc.
1020 Wasco Street, Suite 1
Hood River, OR 97031
541.386.9003
www.interfluve.com

Stream and Habitat Inventory
Plan View: 1000+00 to 1033+00

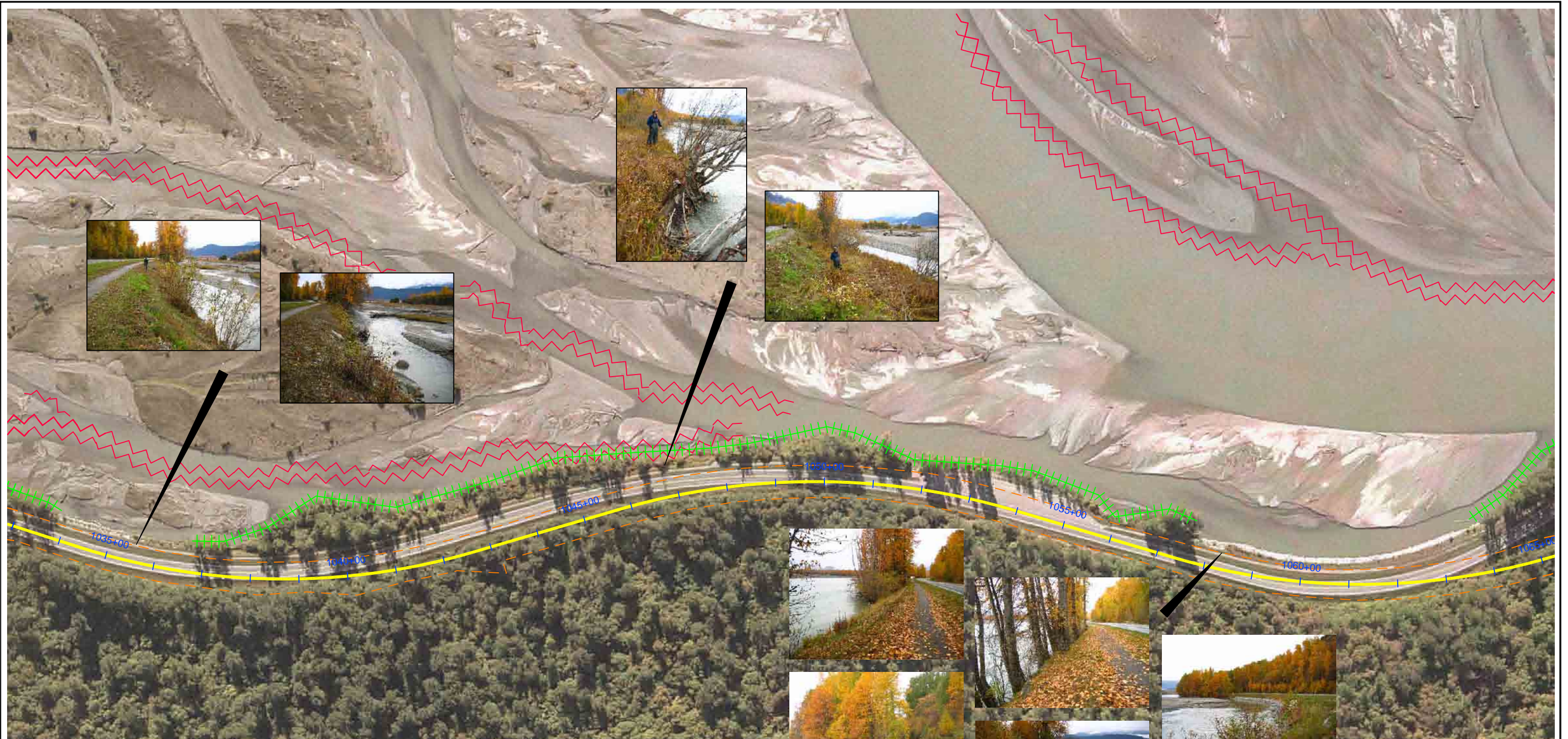

STATION 1020+00 TO 1034+00
SALMON REARING
COHO AND CHINOOK SALMON REARING

STATION 981+00 TO 1118+00
SALMON SPAWNING
CHUM AND COHO SPAWN IN THIS AREA FROM SEPTEMBER THROUGH DECEMBER

STATION 1037+00 TO 1058+00
SALMON REARING
COHO AND CHINOOK SALMON REARING

STATION 1064+00 TO 1125+00
SALMON REARING
COHO AND CHINOOK SALMON REARING

GENERAL NOTES:
THE INITIAL STREAM SURVEY WAS CONDUCTED BETWEEN 10/4/05 AND 10/9/05, AND WAS UPDATED IN MAY AND JUNE 2006. THE STREAMS ARE ORGANIZED BY THE STATIONING OF THE HIGHWAY CROSSING CULVERT. WHERE POSSIBLE, THE STREAM HAS BEEN IDENTIFIED BY ITS ALASKA DEPARTMENT OF FISH AND GAME ANADROMOUS WATERS CATALOG (AWC) NUMBER. LISTED FISH USE INCORPORATES FIELD OBSERVATION, MAY 2006 TRAPPING RESULTS BY OHMP, AND AWC NOTES.

ALL AREAS OF THE CHILKAT RIVER ADJACENT TO THE HIGHWAY LIKELY SERVE AS MIGRATION AND REARING HABITAT FOR ALL FIVE SPECIES OF PACIFIC SALMON AS WELL AS DOLLY VARDEN, CUTTHROAT AND STEELHEAD. SOME SPECIFIC REARING LOCATIONS HAVE BEEN IDENTIFIED. OTHER HABITAT FUNCTIONS NOTED ON THIS SHEET ARE IN ADDITION TO THESE USES.

LEGEND

- SPAWNING AREA
- REARING



SCALE IN FEET



HAINES_BASE_SET.dwg

NO.	BY	DATE	REVISION DESCRIPTION

RP	DM,GK,MS	DM,GK,MS
DRAWN	DESIGNED	CHECKED
DM,GK,MS	06/30/06	
APPROVED	DATE	PROJECT

State of Alaska Department of Transportation
and Public Facilities – Haines, Alaska
Haines Highway – MP 3.5 to 25.3

Prepared By
Inter-Fluve, Inc.
1020 Wasco Street, Suite 1
Hood River, OR 97031
541.386.9003
www.interfluve.com

Stream and Habitat Inventory
Plan View: 1033+00 to 1065+00
SHEET 29 OF 36

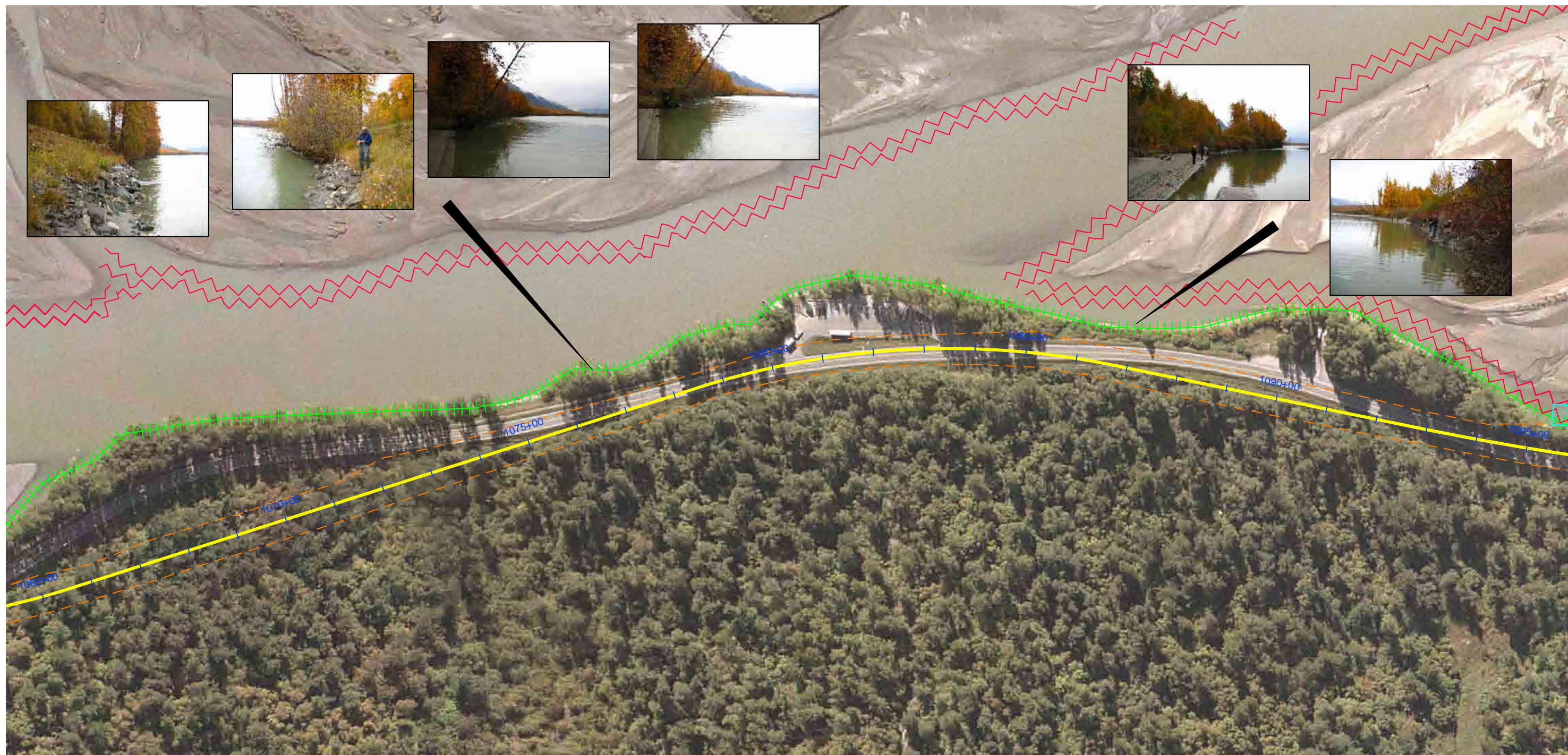

GENERAL NOTES:
 THE INITIAL STREAM SURVEY WAS CONDUCTED BETWEEN 10/4/05 AND 10/9/05, AND WAS UPDATED IN MAY AND JUNE 2006. THE STREAMS ARE ORGANIZED BY THE STATIONING OF THE HIGHWAY CROSSING CULVERT. WHERE POSSIBLE, THE STREAM HAS BEEN IDENTIFIED BY ITS ALASKA DEPARTMENT OF FISH AND GAME ANADROMOUS WATERS CATALOG (AWC) NUMBER. LISTED FISH USE INCORPORATES FIELD OBSERVATION, MAY 2006 TRAPPING RESULTS BY OHMP, AND AWC NOTES.

ALL AREAS OF THE CHILKAT RIVER ADJACENT TO THE HIGHWAY LIKELY SERVE AS MIGRATION AND REARING HABITAT FOR ALL FIVE SPECIES OF PACIFIC SALMON AS WELL AS DOLLY VARDEN, CUTTHROAT AND STEELHEAD. SOME SPECIFIC REARING LOCATIONS HAVE BEEN IDENTIFIED. OTHER HABITAT FUNCTIONS NOTED ON THIS SHEET ARE IN ADDITION TO THESE USES.

STATION 981+00 TO 1118+00
SALMON SPAWNING
 CHUM AND COHO SPAWN IN THIS AREA FROM SEPTEMBER THROUGH DECEMBER

STATION 1064+00 TO 1125+00
SALMON REARING
 COHO AND CHINOOK SALMON REARING

LEGEND

-  SPAWNING AREA
-  REARING

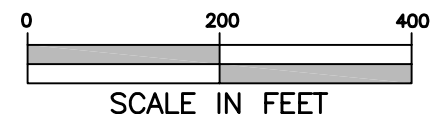

HAINES_BASE_SET.dwg

NO.	BY	DATE	REVISION	DESCRIPTION

RP	DM,GK,MS	DM,GK,MS
DRAWN	DESIGNED	CHECKED
DM,GK,MS	06/30/06	
APPROVED	DATE	PROJECT

State of Alaska Department of Transportation
 and Public Facilities – Haines, Alaska
 Haines Highway – MP 3.5 to 25.3

Prepared By:
 Inter-Fluve, Inc.

1020 Wasco Street, Suite 1
 Hood River, OR 97031
 541.386.9003
 www.interfluve.com

Stream and Habitat Inventory
 Plan View: 1065+00 to 1095+00

SHEET
 30 OF 36

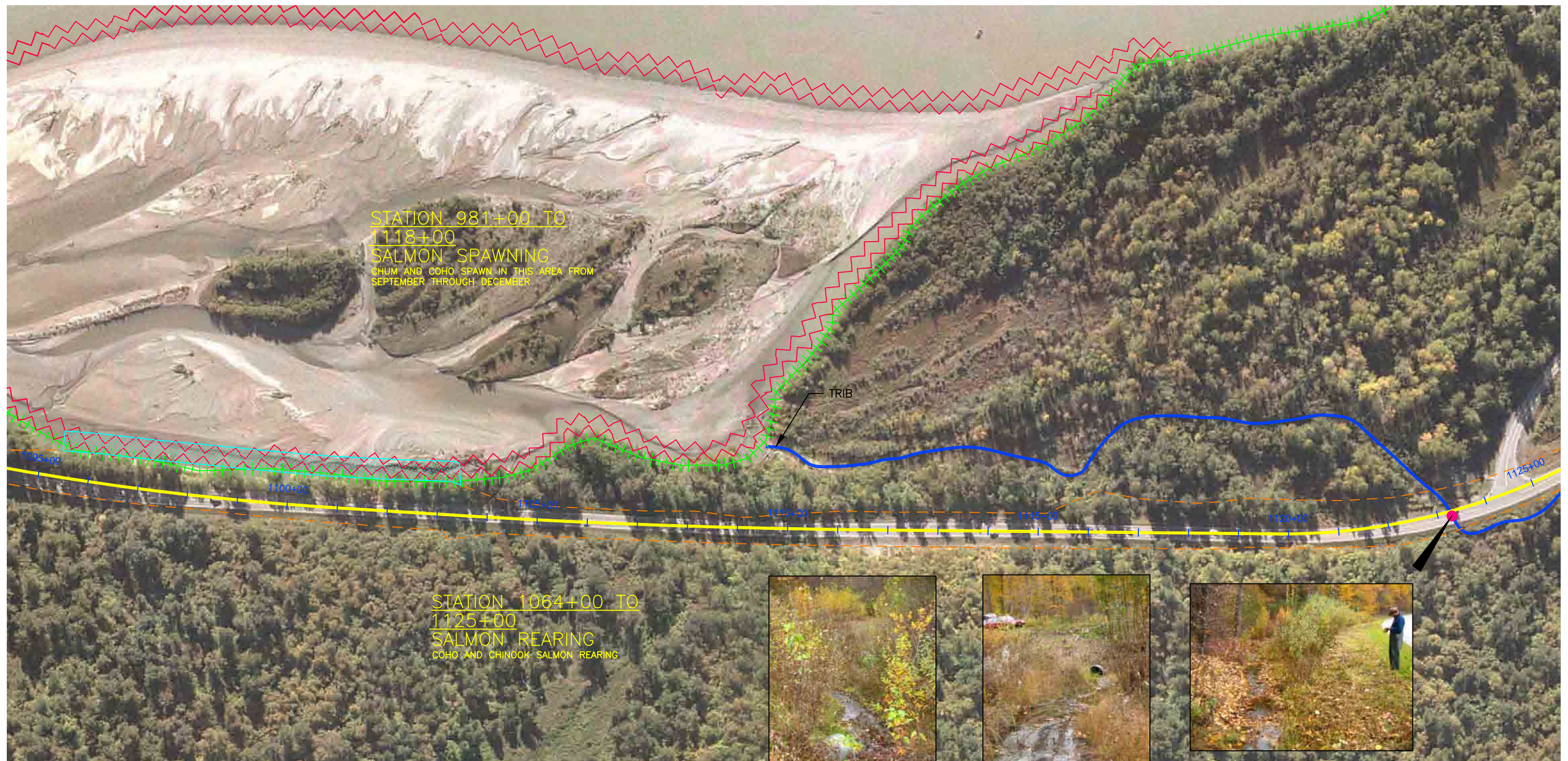

STATION 981+00 TO
1118+00
SALMON SPAWNING
CHUM AND COHO SPAWN IN THIS AREA FROM
SEPTEMBER THROUGH DECEMBER

STATION 1064+00 TO
1125+00
SALMON REARING
COHO AND CHINOOK SALMON REARING



GENERAL NOTES:
THE INITIAL STREAM SURVEY WAS CONDUCTED BETWEEN 10/4/05 AND 10/9/05, AND WAS UPDATED IN MAY AND JUNE 2006. THE STREAMS ARE ORGANIZED BY THE STATIONING OF THE HIGHWAY CROSSING CULVERT. WHERE POSSIBLE, THE STREAM HAS BEEN IDENTIFIED BY ITS ALASKA DEPARTMENT OF FISH AND GAME ANADROMOUS WATERS CATALOG (AWC) NUMBER. LISTED FISH USE INCORPORATES FIELD OBSERVATION, MAY 2006 TRAPPING RESULTS BY OHMP, AND AWC NOTES.

ALL AREAS OF THE CHILKAT RIVER ADJACENT TO THE HIGHWAY LIKELY SERVE AS MIGRATION AND REARING HABITAT FOR ALL FIVE SPECIES OF PACIFIC SALMON AS WELL AS DOLLY VARDEN, CUTTHROAT AND STEELHEAD. SOME SPECIFIC REARING LOCATIONS HAVE BEEN IDENTIFIED. OTHER HABITAT FUNCTIONS NOTED ON THIS SHEET ARE IN ADDITION TO THESE USES.

BANK STATION 1095+25
TO 1103+50

TRIB STATION 1123+25

CATALOG NUMBER: 115-32-10250-2070
STREAM NAME: 2 1/2 MILE CREEK
FISH USE: REARING COHO AND DOLLY VARDEN. SPAWNING CHUM AND COHO
DESCRIPTION: UPSTREAM OF THE CULVERTS THE STREAM IS 1-2' WIDE AND COMPOSED OF RIFFLE HABITAT. THE STREAM RUNS ALONGSIDE THE ROAD UP TO STATION 1128+25 BEFORE THE CHANNEL TURNS AWAY FROM THE ROAD. FOR THE FIRST 150' ABOVE THE CULVERT THE STREAM LIES AWAY FROM THE TOE OF THE ROAD FILL SLOPE AND COVER IS PROVIDED BY ADJACENT WILLOW AND ALDER. THE STREAM THEN RUNS TIGHT ALONG THE TOE AND THE BANKS ARE VEGETATED WITH GRASSES. DOWNSTREAM OF THE CULVERT THE STREAM FLOWS THROUGH A MANIPULATED HABITAT WITH PATCHES OF WILLOW AND GRASSES BEGINNING TO BE ESTABLISHED. FOR BOTH PORTIONS OF THE STREAM THE SUBSTRATE IS SMALL GRAVEL.

LEGEND

- S&HI CULVERT LOCATION
- MATURE - FORESTED
- ~ SPAWNING AREA
- - - - REARING

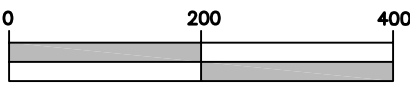
SCALE IN FEET

HAINES_BASE_SET.dwg

NO.	BY	DATE	REVISION	DESCRIPTION

RP	DM,GK,MS	DM,GK,MS
DRAWN	DESIGNED	CHECKED
DM,GK,MS	06/30/06	
APPROVED	DATE	PROJECT

State of Alaska Department of Transportation
and Public Facilities - Haines, Alaska
Haines Highway - MP 3.5 to 25.3

Prepared By:
Inter-Fluve, Inc.
1020 Wasco Street, Suite 1
Hood River, OR 97031
541.386.9003
www.interfluve.com

Stream and Habitat Inventory
Plan View: 1095+00 to 1125+00
SHEET
31 of 36



GENERAL NOTES:
 THE INITIAL STREAM SURVEY WAS CONDUCTED BETWEEN 10/4/05 AND 10/9/05, AND WAS UPDATED IN MAY AND JUNE 2006. THE STREAMS ARE ORGANIZED BY THE STATIONING OF THE HIGHWAY CROSSING CULVERT. WHERE POSSIBLE, THE STREAM HAS BEEN IDENTIFIED BY ITS ALASKA DEPARTMENT OF FISH AND GAME ANADROMOUS WATERS CATALOG (AWC) NUMBER. LISTED FISH USE INCORPORATES FIELD OBSERVATION, MAY 2006 TRAPPING RESULTS BY OHMP, AND AWC NOTES.

ALL AREAS OF THE CHILKAT RIVER ADJACENT TO THE HIGHWAY LIKELY SERVE AS MIGRATION AND REARING HABITAT FOR ALL FIVE SPECIES OF PACIFIC SALMON AS WELL AS DOLLY VARDEN, CUTTHROAT AND STEELHEAD. HABITAT FUNCTIONS NOTED ON THIS SHEET ARE IN ADDITION TO THESE USES.

TRIB STATION 1123+25
 SEE SHEET 31

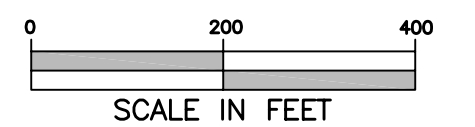

HAINES_BASE_SET.dwg

NO.	BY	DATE	REVISION	DESCRIPTION

RP	DM,GK,MS	DM,GK,MS
DRAWN	DESIGNED	CHECKED
DM,GK,MS	06/30/06	
APPROVED	DATE	PROJECT

State of Alaska Department of Transportation
 and Public Facilities – Haines, Alaska
 Haines Highway – MP 3.5 to 25.3

Prepared By
 Inter-Fluve, Inc.

1020 Wasco Street, Suite 1
 Hood River, OR 97031
 541.386.9003
 www.interfluve.com

Stream and Habitat Inventory
 Plan View: 1125+00 to 1155+00

SHEET
 32 of 36



GENERAL NOTES:
 THE INITIAL STREAM SURVEY WAS CONDUCTED BETWEEN 10/4/05 AND 10/9/05, AND WAS UPDATED IN MAY AND JUNE 2006. THE STREAMS ARE ORGANIZED BY THE STATIONING OF THE HIGHWAY CROSSING CULVERT. WHERE POSSIBLE, THE STREAM HAS BEEN IDENTIFIED BY ITS ALASKA DEPARTMENT OF FISH AND GAME ANADROMOUS WATERS CATALOG (AWC) NUMBER. LISTED FISH USE INCORPORATES FIELD OBSERVATION, MAY 2006 TRAPPING RESULTS BY OHMP, AND AWC NOTES.

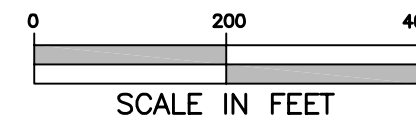

HAINES_BASE_SET.dwg

NO.	BY	DATE	REVISION	DESCRIPTION

RP	DM,GK,MS	DM,GK,MS
DRAWN	DESIGNED	CHECKED
DM,GK,MS	06/30/06	
APPROVED	DATE	PROJECT

State of Alaska Department of Transportation
 and Public Facilities – Haines, Alaska
 Haines Highway – MP 3.5 to 25.3

Prepared By:
 Inter-Fluve, Inc.
 1020 Wasco Street, Suite 1
 Hood River, OR 97031
 541.386.9003
 www.interfluve.com

Stream and Habitat Inventory
 Plan View: 1155+00 to 1185+00

SHEET
 33 OF 36



PROPOSED ACTION ALIGNMENT

OPTION B ALIGNMENT

GENERAL NOTES:
 THE INITIAL STREAM SURVEY WAS CONDUCTED BETWEEN 10/4/05 AND 10/9/05, AND WAS UPDATED IN MAY AND JUNE 2006. THE STREAMS ARE ORGANIZED BY THE STATIONING OF THE HIGHWAY CROSSING CULVERT. WHERE POSSIBLE, THE STREAM HAS BEEN IDENTIFIED BY ITS ALASKA DEPARTMENT OF FISH AND GAME ANADROMOUS WATERS CATALOG (AWC) NUMBER. LISTED FISH USE INCORPORATES FIELD OBSERVATION, MAY 2006 TRAPPING RESULTS BY OHMP, AND AWC NOTES.

ALL AREAS OF THE CHILKAT RIVER ADJACENT TO THE HIGHWAY LIKELY SERVE AS MIGRATION AND REARING HABITAT FOR ALL FIVE SPECIES OF PACIFIC SALMON AS WELL AS DOLLY VARDEN, CUTTHROAT AND STEELHEAD. HABITAT FUNCTIONS NOTED ON THIS SHEET ARE IN ADDITION TO THESE USES.

TRIB STATION 1200+60

FISH USE: UNKNOWN
 DESCRIPTION: DUE TO THE FREQUENT INFLUX OF SLIDE OR HEADCUT MATERIAL, ANY PRODUCTIVE HABITAT ABOVE THIS CULVERT WOULD BE EPHEMERAL IN NATURE. THERE IS NO ESTABLISHED VEGETATION AND THE 5-10' WIDE STREAM LACKS ANY STABILITY OF FORM. ADDITIONALLY, THE SHEET FLOW DOWN THE CONCRETE LINED CULVERT LIKELY PREVENTS ANY UPSTREAM PASSAGE OF FISH, SHOULD THEY EVER MAKE IT UP TO THE CULVERT OUTLET. DOWNSTREAM OF THE CULVERT THE STREAM IS A FAST RIFFLE FLOWING THROUGH BOULDERS. THERE IS LITTLE VEGETATION FOR SEVERAL HUNDRED FEET.

LEGEND

● S&HI CULVERT LOCATION

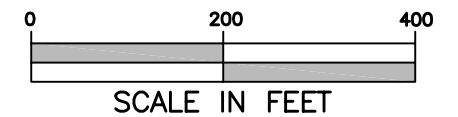

HAINES_BASE_SET.dwg

NO.	BY	DATE	REVISION	DESCRIPTION

RP	DM,GK,MS	DM,GK,MS
DRAWN	DESIGNED	CHECKED
DM,GK,MS	06/30/06	
APPROVED	DATE	PROJECT

State of Alaska Department of Transportation
 and Public Facilities – Haines, Alaska
 Haines Highway – MP 3.5 to 25.3

Prepared By:
 Inter-Fluve, Inc.

1020 Wasco Street, Suite 1
 Hood River, OR 97031
 541.386.9003
 www.interfluve.com

Stream and Habitat Inventory
 Plan View: 1185+00 to 1212+00

SHEET
 34 OF 36

HAINES_BASE_SET.dwg

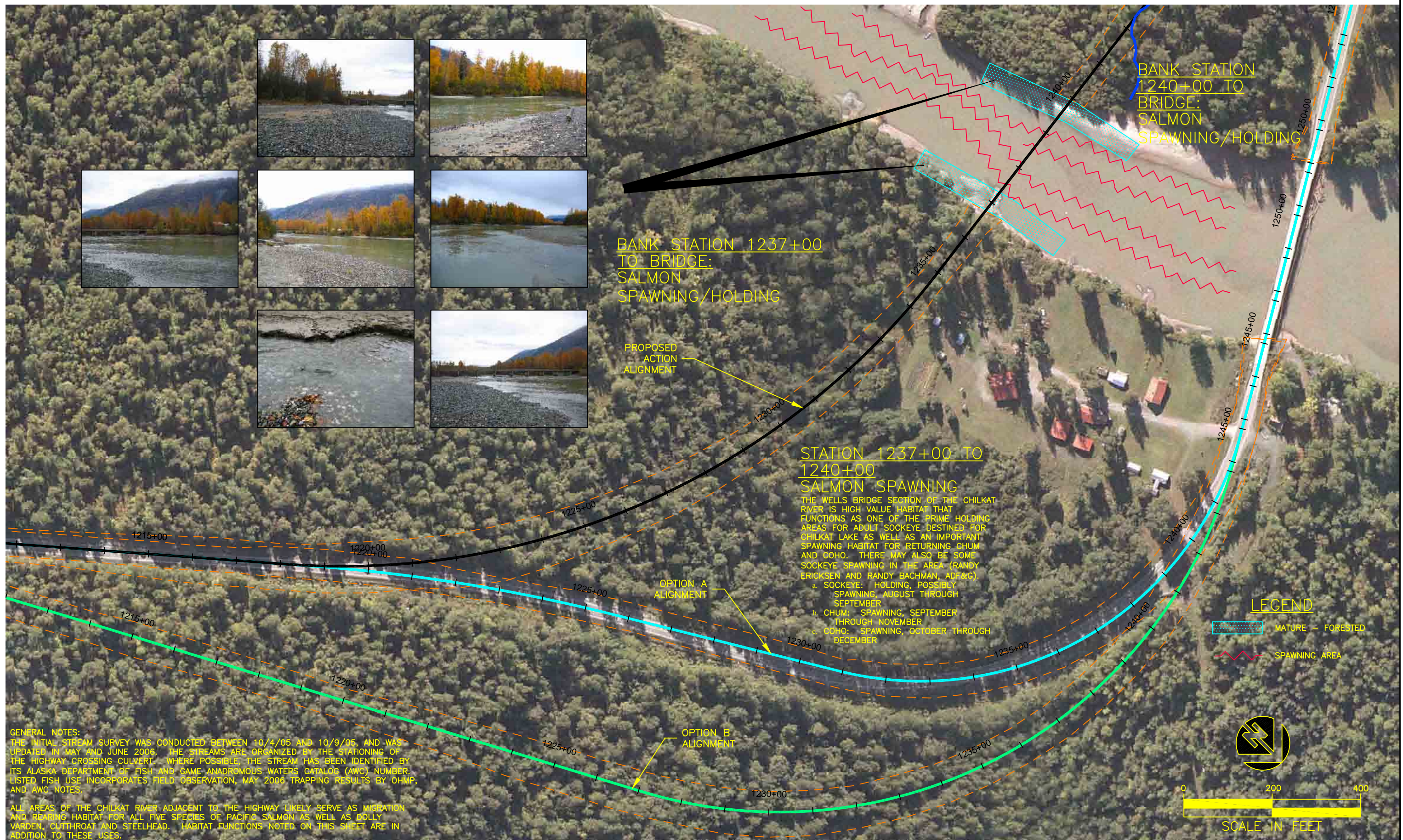

GENERAL NOTES:
 THE INITIAL STREAM SURVEY WAS CONDUCTED BETWEEN 10/4/05 AND 10/9/05, AND WAS UPDATED IN MAY AND JUNE 2006. THE STREAMS ARE ORGANIZED BY THE STATIONING OF THE HIGHWAY CROSSING CULVERT. WHERE POSSIBLE, THE STREAM HAS BEEN IDENTIFIED BY ITS ALASKA DEPARTMENT OF FISH AND GAME ANADROMOUS WATERS CATALOG (AWC) NUMBER. LISTED FISH USE INCORPORATES FIELD OBSERVATION, MAY 2006 TRAPPING RESULTS BY OHMP, AND AWC NOTES.

ALL AREAS OF THE CHILKAT RIVER ADJACENT TO THE HIGHWAY LIKELY SERVE AS MIGRATION AND REARING HABITAT FOR ALL FIVE SPECIES OF PACIFIC SALMON AS WELL AS DOLLY VARDEN, CUTTHROAT AND STEELHEAD. HABITAT FUNCTIONS NOTED ON THIS SHEET ARE IN ADDITION TO THESE USES.

BANK STATION 1237+00 TO BRIDGE: SALMON SPAWNING/HOLDING

BANK STATION 1240+00 TO BRIDGE: SALMON SPAWNING/HOLDING

STATION 1237+00 TO 1240+00 SALMON SPAWNING

THE WELLS BRIDGE SECTION OF THE CHILKAT RIVER IS HIGH VALUE HABITAT THAT FUNCTIONS AS ONE OF THE PRIME HOLDING AREAS FOR ADULT SOCKEYE DESTINED FOR CHILKAT LAKE AS WELL AS AN IMPORTANT SPAWNING HABITAT FOR RETURNING CHUM AND COHO. THERE MAY ALSO BE SOME SOCKEYE SPAWNING IN THE AREA (RANDY ERICKSEN AND RANDY BACHMAN, ADF&G).

- a. SOCKEYE: HOLDING, POSSIBLY SPAWNING, AUGUST THROUGH SEPTEMBER
- b. CHUM: SPAWNING, SEPTEMBER THROUGH NOVEMBER
- c. COHO: SPAWNING, OCTOBER THROUGH DECEMBER

LEGEND

- MATURE - FORESTED
- SPAWNING AREA



NO.	BY	DATE	REVISION	DESCRIPTION

RP	DM,GK,MS	DM,GK,MS
DRAWN	DESIGNED	CHECKED
DM,GK,MS	06/30/06	
APPROVED	DATE	PROJECT

State of Alaska Department of Transportation
 and Public Facilities - Haines, Alaska
 Haines Highway - MP 3.5 to 25.3

Prepared By:
 Inter-Fluve, Inc.
 1020 Wasco Street, Suite 1
 Hood River, OR 97031
 541.386.9003
 www.interfluve.com

Stream and Habitat Inventory
 Plan View: 1212+00 to 1242+00

SHEET
 35 of 36

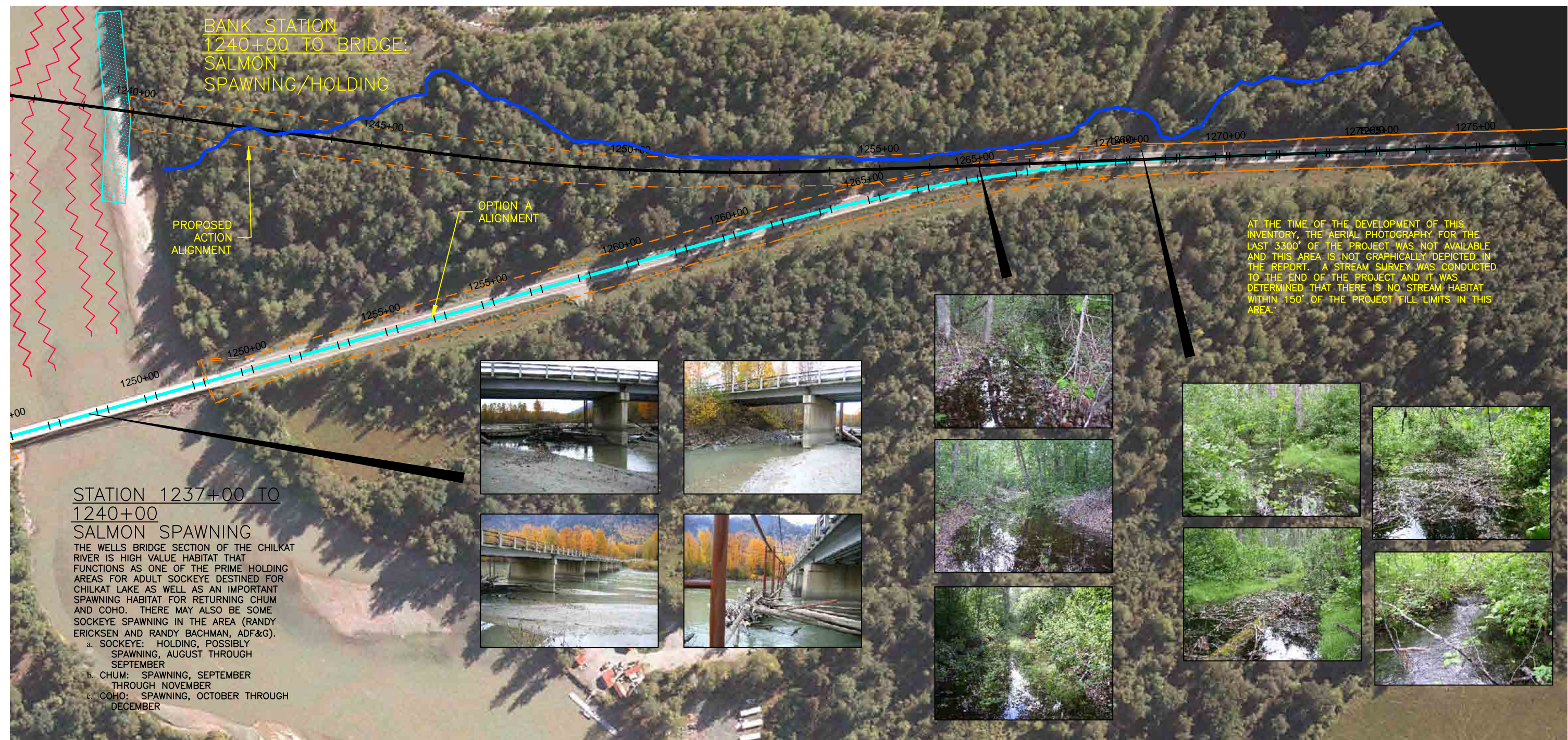

**BANK STATION
1240+00 TO BRIDGE:
SALMON
SPAWNING/HOLDING**

**PROPOSED
ACTION
ALIGNMENT**

**OPTION A
ALIGNMENT**

AT THE TIME OF THE DEVELOPMENT OF THIS INVENTORY, THE AERIAL PHOTOGRAPHY FOR THE LAST 3300' OF THE PROJECT WAS NOT AVAILABLE AND THIS AREA IS NOT GRAPHICALLY DEPICTED IN THE REPORT. A STREAM SURVEY WAS CONDUCTED TO THE END OF THE PROJECT AND IT WAS DETERMINED THAT THERE IS NO STREAM HABITAT WITHIN 150' OF THE PROJECT FILL LIMITS IN THIS AREA.

**STATION 1237+00 TO
1240+00
SALMON SPAWNING**

THE WELLS BRIDGE SECTION OF THE CHILKAT RIVER IS HIGH VALUE HABITAT THAT FUNCTIONS AS ONE OF THE PRIME HOLDING AREAS FOR ADULT SOCKEYE DESTINED FOR CHILKAT LAKE AS WELL AS AN IMPORTANT SPAWNING HABITAT FOR RETURNING CHUM AND COHO. THERE MAY ALSO BE SOME SOCKEYE SPAWNING IN THE AREA (RANDY ERICKSEN AND RANDY BACHMAN, ADF&G).

- a. SOCKEYE: HOLDING, POSSIBLY SPAWNING, AUGUST THROUGH SEPTEMBER
- b. CHUM: SPAWNING, SEPTEMBER THROUGH NOVEMBER
- c. COHO: SPAWNING, OCTOBER THROUGH DECEMBER



GENERAL NOTES:
THE INITIAL STREAM SURVEY WAS CONDUCTED BETWEEN 10/4/05 AND 10/9/05, AND WAS UPDATED IN MAY AND JUNE 2006. THE STREAMS ARE ORGANIZED BY THE STATIONING OF THE HIGHWAY CROSSING CULVERT. WHERE POSSIBLE, THE STREAM HAS BEEN IDENTIFIED BY ITS ALASKA DEPARTMENT OF FISH AND GAME ANADROMOUS WATERS CATALOG (AWC) NUMBER. LISTED FISH USE INCORPORATES FIELD OBSERVATION, MAY 2006 TRAPPING RESULTS BY OHMP, AND AWC NOTES.

ALL AREAS OF THE CHILKAT RIVER ADJACENT TO THE HIGHWAY LIKELY SERVE AS MIGRATION AND REARING HABITAT FOR ALL FIVE SPECIES OF PACIFIC SALMON AS WELL AS DOLLY VARDEN, CUTTHROAT AND STEELHEAD. HABITAT FUNCTIONS NOTED ON THIS SHEET ARE IN ADDITION TO THESE USES.

TRIB STATION 1240+75 TO 1271+00 (PROPOSED ACTION ALIGNMENT STATIONING)

CATALOG NUMBER: 115-32-10250-2079
STREAM NAME: 25 MILE CREEK
FISH USE: REARING AND SPAWNING COHO AND DOLLY VARDEN
DESCRIPTION: THIS IS AN OLD FLOOD CHANNEL OF THE KLEHINI RIVER. DURING TIMES OF HIGH GROUNDWATER LEVELS THIS CHANNEL FILLS, FED PRIMARILY BY THE 25 MILE POND, BUT ALSO BY GROUNDWATER UPWELLING. AT LOW WATER LEVELS THE STREAM IS DRY. NEAR STATION 1271+00 THE STREAM IS ABOUT 500' FROM THE CURRENT HIGHWAY AND TURNS FURTHER TO THE SOUTH. ON JUNE 16, 2006, THE 10-15' WIDE CHANNEL BETWEEN STATIONS 1261+00 AND 1271+00 WAS FLOODED TO A DEPTH OF 2-3'. THE STREAM BANKS ARE HEAVILY VEGETATED AND THE STREAM SUBSTRATE IS LEAF LITTER OVER GRAVEL. NEAR STATION 1260+00 THE STREAM WAS FLOWING OVER AN ACCESS ROAD AND DISSIPATING INTO THE GROUND, APPEARING ONLY AS ISOLATED POOLS FOR THE NEXT 350'. NEAR STATION 1257+00 THERE IS ONCE MORE A DEFINED FLOOD CHANNEL, WIDENING FROM 4' TO 8' BY STATION 1253+00. THERE WAS NO FLOW VISIBLE IN THIS SECTION, AND THE WATER DEPTH WAS 0.5-1.5'. THE CHANNEL NARROWS TO 3-4' WIDE AT STATION 1245+00. AT THE TIME OF THIS FIELD VISIT, THE CHILKAT RIVER WAS FLOODING THROUGH THE TREES ALONG THE RIVER'S EDGE AND THE STREAM OUTLET (IF ANY) WAS FLOODED.

LEGEND

- MATURE - FORESTED
- SPAWNING AREA

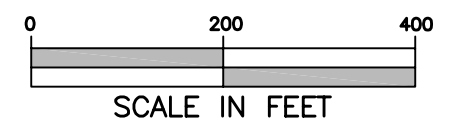

HAINES_BASE_SET.dwg

NO.	BY	DATE	REVISION DESCRIPTION

RP	DM,GK,MS	DM,GK,MS
DRAWN	DESIGNED	CHECKED
DM,GK,MS	06/30/06	
APPROVED	DATE	PROJECT

State of Alaska Department of Transportation
and Public Facilities - Haines, Alaska
Haines Highway - MP 3.5 to 25.3

Prepared By:
Inter-Fluve, Inc.
1020 Wasco Street, Suite 1
Hood River, OR 97031
541.386.9003
www.interfluve.com

Stream and Habitat Inventory
Plan View: 1238+00 to 1276+00
SHEET
36 OF 36

APPENDIX C

**Hydrology and Hydraulics Report
(available on attached CD)**

**Location Hydraulic Study
and
Preliminary Hydrology and Hydraulics Report
Haines Highway Milepost 3.5 to 25.3**

ADOT&PF Project No. 68606 / SHAK-095-6(28)



Prepared for:
DOWL HKM
4040 B Street
Anchorage, AK 99503

Prepared by:
Inter-Fluve, Inc.
1020 Wasco Street, Suite I
Hood River, OR 97031
541.386.9003
www.interfluve.com

DRAFT

October 30, 2009

(Intentionally blank)

1. Table of Contents

1.	Table of Contents.....	ii
2.	Executive summary.....	1
3.	Introduction.....	3
4.	Chilkat River.....	11
5.	Culvert Replacement at Station 222+51	29
6.	Culvert Replacement at Station 319+13	34
7.	Culvert Replacement at Station 324+79	38
8.	Culvert Replacement at Station 483+18	43
9.	Culvert Replacement at Station 512+24	47
10.	Culvert Replacement at Station 589+12	52
11.	Culvert Replacement at Station 647+20	56
12.	Culvert Installation at Station 652+70.....	61
13.	Culvert Replacement at Station 710+75	62
14.	Culvert Replacement at Station 865+88	67
15.	Culvert Replacement at Station 887+60	72
16.	Culvert Replacement at Station 962+06	78
17.	Culvert Replacement at Station 973+30	80
18.	Culvert Replacement at Station 1102+19	82
19.	Culvert Replacement at Station 1179+75	86
20.	Culvert Replacement at Station 1187+25	87
21.	Small Fish Culverts.....	89
22.	References:.....	99
23.	Appendices:.....	101

1.1 Table of Tables

Table 3-1. USGS Regional Regression equations for estimating flood magnitude for various recurrence intervals. Equations are applicable to southeast Alaska (Curran et al. 2003).....	8
Table 3-2. Flow estimates for tributary basins using USGS Regional Regression Equations (Curran et al. 2003).	9
Table 4-1. Results of flow calculations for the Upper Chilkat Gage location using Log Pearson Type III Analysis and USGS regional regression equations.	20
Table 4-2. Final flow estimates for locations along the lower mainstem Chilkat River. Values in cubic feet per second.....	21
Table 5-1. 222+51 Hydrologic and Hydraulic Summary	31
Table 6-1. 319+13 Hydrologic and Hydraulic Summary	36
Table 7-1. 324+79 Hydrologic and Hydraulic Summary	40
Table 8-1. 483+18 Hydrologic and Hydraulic Summary	45
Table 9-1. 512+24 Hydrologic and Hydraulic Summary	49
Table 10-1. 589+12 Hydrologic and Hydraulic Summary	54
Table 11-1. 647+20 Hydrologic and Hydraulic Summary	59
Table 12-1. 973+30 Hydrologic and Hydraulic Summary	61
Table 13-1. 710+75 Hydrologic and Hydraulic Summary	64
Table 14-1. 865+88 Hydrologic and Hydraulic Summary	69
Table 15-1. 887+60 Hydrologic and Hydraulic Summary	74
Table 16-1. 962+06 Hydrologic and Hydraulic Summary	78
Table 17-1. 973+30 Hydrologic and Hydraulic Summary	80
Table 18-1. 1102+19 Hydrologic and Hydraulic Summary	84
Table 19-1. 1179+75 Hydrologic and Hydraulic Summary	86
Table 20-1. 1187+25 Hydrologic and Hydraulic Summary	87

1.2 Table of Figures

Figure 1. Map of Tributary Basins.....	7
Figure 2. Map of the Chilkat Basin.....	12
Figure 3. ADF&G staff gage readings near Sta 395+00.....	16

2. Executive summary

This report presents design concepts for roadway embankment erosion protection along the Chilkat River; and, flood conveyance and fish passage at a number of culverts along tributary streams. Design features are in support of the Preliminary Engineering Report (PER) and are based on the 2009 design alignment provided by DOWL HKM. There is a companion Stream and Habitat Inventory (S&HI) prepared by Inter-Fluve, Inc. (Inter-Fluve, July, 2006) based on a 2006 version of the design alignment which provides a graphical overview of the project.

The proposed Haines Highway realignment project between mileposts 3.5 and 25.3 follows the Chilkat River and crosses 106 culvert locations. The highway embankment along the Chilkat River was conceptually designed for erosion and depth of scour protection. The analysis and design follow methods in the Highway Preconstruction Manual and Highway Drainage Manual and are presented in Section 4.

All culverts located in the field were evaluated in the field by rapid assessment methods and are summarized in tabular format in the appendices. A total of 28 culverts are discussed in greater detail in this report. Of these culvert crossings, eleven are either 48-inch diameter or larger, or of approximately equivalent size, along fish bearing streams with desirable upstream habitats. An additional four large culverts are located on the two active debris flows at MP 19 and 23. Geotechnical recommendations by DOWL HKM to accommodate debris flows consist of large box culverts to enable equipment access to clean out the occasional debris flow deposits. Details of the design are scheduled for the Draft DSR phase. Thirteen smaller pipes were identified that had fish presence and will require fish passage for the replacement culverts. Analysis and design of large culverts and culverts along fish bearing streams follow methods in the Highway Preconstruction Manual and Highway Drainage Manual and are presented in Sections 5 through 20. Analysis and design of the smaller fish pipes are discussed in Section 21.

A summary table of culverts considered in this report is presented on the following page.

Culvert Summary.

2009 Station	Proposed fish passage design method (MOA, 2001)	Proposed Culvert	
		size	type
Large culverts			
222+51	tier 1	6'-9"x4'-11"	pipe arch
319+13	tier 1	6'-9"x4'-11"	pipe arch
324+79	tier 1	7'-3"x5'-3"	pipe arch
483+18	tier 1	7'-3"x5'-3"	pipe arch
512+24	tier 1	14'-1"x6'-2"	alum box
589+12	tier 1	7'-3"x5'-3"	pipe arch
647+20	tier 1	8'-10"x6'-1"	pipe arch
652+70	tier 1	pending	pending
710+75	tier 1	12'-7"x8'-4"	pipe arch
865+88	tier 1	11'-7"x7'-5"	pipe arch
887+60	tier 1	9'-4"x6'-3"	pipe arch
962+06	Debris flow	pending	pending
973+30	Debris flow	pending	pending
1102+19	tier 1	7'-3"x5'-3"	pipe arch
1179+75	Debris flow	pending	pending
1187+25	Debris flow	pending	pending
Smaller Culverts			
228+95	tier 2 - no baffles	2'	cmp
240+38	tier 2 - no baffles	2'	cmp
245+19	tier 1	4'	cmp
248+45	tier 1	3'	cmp
292+90	tier 2 - baffled pipe	4'	cmp
314+72	tier 2 - no baffles	3'	cmp
366+36	tier 1	3'-6"x2'-5"	pipe arch
382+07	tier 2	3'	cmp
419+95	tier 2 - baffled pipe	3.5'	cmp
530+70	tier 1	3'	cmp
606+68	tier 2	2'	cmp
736+83 – option 1	tier 1	7'-4"x5'-4"	pipe arch
option 2	tier 2 - baffled pipe	3'	cmp
767+14	tier 2 - baffled pipe	3.5'	cmp

3. Introduction

The Haines Highway realignment study involves the Resurfacing, Rehabilitation and Restoration (3R) reconstruction of the highway between mileposts 3.5 and 25.3. This work is necessary to improve safety by bringing the highway into compliance with current design standards. Completion of this stretch will connect with previously constructed improvements for an improved highway between Haines and the border with Canada.

This study is a preliminary level hydrologic and hydraulic evaluation of the Chilkat River and tributary drainages that cross the Haines Highway between mileposts 3.5 and 25.3. Conceptual level designs and drawings for erosion protection along the highway embankment and preliminary design of fish passage and flood conveyance at larger culverts are included in this study. This report is submitted in support of the Preliminary Engineering Report (PER). This report was prepared in accordance with the Highway Preconstruction Manual (HPM) 1120.5 and the Alaska Highway Drainage Manual (HDM). Final designs will require detailed survey for each stream crossing and will be prepared and documented in a final design report to be submitted with Plans-in-Hand. This report provides information for preliminary design and environmental/permitting actions.

A companion Stream and Habitat Inventory Study (S&HI) was prepared by Inter-Fluve, Inc. (July 2006) which is included herein by reference for a graphical overview of the project.

3.1 Objective

The objective of this report is to characterize hydrologic and hydraulic conditions of the Chilkat River and tributary crossings of the highway. Further, conceptual level designs for typical erosion protection and passage of flood flows and fish through larger culverts were prepared for environmental/permitting actions. Full designs will be prepared at a later phase for submittal with the Plans-in-Hand.

3.1.1 Objective - Chilkat River

The Chilkat River is a large, dynamic, glacially fed river. There is a complex network of side channels between mileposts 10 and 19. Further, the Chilkat River discharges to the Lynn Canal which experiences 16.5-ft tidal fluctuations. No Federal Emergency Management Agency (FEMA) Flood Insurance Study for the project reach was identified. The Haines Highway follows the northeast bank of the river, with river flows along the embankment toe for long stretches of highway. In a number of locations, side channels impinge directly into the highway embankment then turn downstream at sharp angles.

The objective of this study along the Chilkat River and its side channels was to estimate the erosive forces acting on the proposed road embankment for conceptual design of bank revetments. Depths and locations of scour were investigated in the field and conceptually

analyzed to aid in estimating depth of scour along the toe of the proposed embankment. The impacts on flood water surface elevations by the proposed project are approximately evaluated.

These objectives were approached through field investigations; interviews with Alaska Department of Transportation and Public Facilities (ADOT&PF) maintenance personnel and long time residents; and, conceptual level analysis and design. Design level analysis and modeling will be completed and documented at a later phase for the Plans-in-Hand submittal.

3.1.2 Objective - Tributaries

Between mileposts 3.5 and 25.3, 106 existing culvert crossings were located in the field. Eight culverts listed in the as-built drawings were not found in the field. An inventory of pipe size and general site conditions was made through a rapid assessment and tabulated (see Appendix Section 23.1).

Of the culverts found, fifteen crossings were identified for this Summary Hydraulic Report. Eleven of the existing crossings are comprised of either 48-inch or larger diameter pipes, or fish bearing streams with ample upstream habitats. An additional four large culverts are located along debris fans - flood runoff and fish passage design will be coordinated with geotechnical design in progress by DOWL HKM for passage of debris torrent sediments. In addition, thirteen smaller pipes are either included in the anadromous waters catalog (AWC) or were identified by Inter-Fluve or Alaska Department of Natural Resources, Office of Habitat Management and Permitting (OHMP) staff to have fish present. A brief narrative of each of these smaller pipes is included in this report. The associated analysis, designs and drawings were prepared to a conceptual level for inclusion in the Preliminary Engineering Report for environmental/permitting actions. Final designs and hydraulic reports will be prepared for submittal with the Plans-in-Hand.

3.2 Field Investigations

On October 5 through 10, 2005, Inter-Fluve conducted field investigations of the hydrologic and hydraulic conditions of the Chilkat River and tributary crossings. The field investigation included: 1) investigation of Chilkat River main stem and side channel scour and bank erosion conditions; 2) inventory and rapid assessment of existing culverts; 3) identification of culverts requiring more detailed study; and 4) cursory total station survey for conceptual design of a number of larger/fish bearing culverts. Conditions immediately following the flood of November 2005 were observed by Inter-Fluve staff and incorporated into the S&HI and this study. In response to design refinements and adjustments of the highway alignment, additional survey was collected in November 2008, May 2009 and October 2009 near Station 888+00 (S&HI station 908+00) and a number of proposed mitigation sites .

Details of the field investigation along the Chilkat River are provided in Section 4.2.

All culverts shown on the 1980 as-built drawings were searched for. A total of 109 crossings, including six with twin pipes, were located. Of the crossings shown on the as-built drawings, eight were not found. A rapid assessment of all found culverts was conducted. The rapid assessment included: size and condition of culvert, inlet/outlet conditions, height to stain line, degree of sedimentation/debris, and photo documentation of inlet/outlet conditions. An inventory of the culverts found in the field with a summary of rapid assessment results is included in a table in Appendix Section 23.1, along with those culverts listed on the as-built drawings that were not found. Based on height to stain line, the majority of the surveyed pipes appeared to be adequately sized. Further, interviews with ADOT&PF maintenance personnel indicated that except for flooding caused by hillside debris flows blocking culvert inlets, to date there has been satisfactory conveyance through the existing pipes. A large magnitude flood occurred during November 2005 and was reported to be as large a flood as recalled. Observations by Mark Sogge (Inter-Fluve, Haines) and Roger Ingledue (ADOT&PF Haines maintenance supervisor) indicate that all occurrences of road overtopping were the result of culverts plugged with sediment and debris (personal communication, March 8, 2006). No evidence of unobstructed pipes having insufficient conveyance capacity was reported.

In preparation for environmental and permitting actions, preliminary designs for flood conveyance and fish passage were prepared for eleven of the larger crossings and thirteen smaller fish bearing pipes identified for more intensive analysis. As noted above, study and design efforts at the four large culverts located along the two debris flows at MP 19 and 23 will be coordinated with geotechnical design during the design phase by DOWL HKM for passage of debris torrent sediments. Detailed site topographic survey, design and final Summary Hydraulic Report for each pipe will be prepared during a later phase and submitted with Plans-in-Hand.

Basic site survey data were collected at the fifteen large culverts identified for more detailed study. As survey coverage was unknown at the time and results of ongoing survey efforts would not be available within the timeframe of the preliminary phase of this study (October-November, 2005), Inter-Fluve used a total station survey gun and rod with prism to collect cursory relative location and elevation survey data including stream profile, typical cross section, culvert invert and crown elevations at the inlet and outlet and typical roadway elevations. The purpose of this survey data collection was to provide the essential site topographic data required to develop conceptual designs. Final design will require site-specific detailed topographic, cross section and profile survey data. The thirteen smaller fish pipes were identified after the field investigations and subsequently added to this study. Survey data from the additional thirteen smaller fish pipes were obtained from the ground based survey of the road embankment by ADOT&PF or Toner-Nordling surveyors (now DOWL HKM) or from the project LIDAR.

3.3 Hydrology - General Methods

3.3.1 Chilkat River

Hydrologic analysis methods for the Chilkat River are presented in Section 4.4.

3.3.2 Tributary Basins

Hydrologic analysis methods conducted in common for the tributary basins are included here, with tributary-specific information included in the individual tributary summaries.

3.3.2.1 Hydrology

Hydrologic analyses were performed for eleven streams with major crossings of the Haines Highway between mileposts 3.5 and 25.3. All streams flow through culverts under the Haines Highway shortly before entering the main stem of the Chilkat River or major Chilkat side channels. These streams have culverts at least 48 inches in diameter and/or contain significant fish habitat. Peak flow estimates for various return periods were estimated in order to analyze flood conveyance and fish passage conditions. As stated in the 2001 *Memorandum of Agreement between the Alaska Department of Fish and Game and the Alaska Department of Transportation and Public Facilities for the Design Permitting and Construction of Culverts for Fish Passage (MOA)*, fish passage design flow is 40 percent of the 2-year peak flow. At this time, hydrologic analysis was not performed for the four streams that are located on debris fans. For these streams, flood runoff and fish passage design will be coordinated with geotechnical recommendations for conveyance of debris flow sediments.

The thirteen smaller fish pipes all drain areas ranging from 0.05- to 0.49-sq. mi. All are smaller than the 0.72-sq mi lower limit for the USGS regional regression estimates for flood runoff flows. Estimates of flows along the additional thirteen smaller fish pipe streams were extrapolated based on area weighting from neighboring larger basins. However, the high degree of variance in hydrologic predictions was suspected to incur unacceptable error. Therefore, an alternate approach was taken: while providing fish passage to meet MOA criteria, the flood conveyance of the proposed structures was verified to be either equal or greater to existing conditions. Details of this analysis are presented in Section 21 – Small Fish Culverts.

The eleven streams for which hydrologic analyses were performed originate in the Takshanuk Mountains northwest of Haines, AK. A map of the basin locations can be found in Figure 1. Basin sizes range from 0.47 mi² to 2.26 mi². Basin elevations range from sea level to over 5,000 feet. The watersheds are steep, with average watershed slopes ranging between 44 and 64 percent. Spruce-dominated forests with poorly-drained soils reach up to approximately 3,000 feet. Unforested alpine slopes characterize the higher elevations. Annual precipitation is approximately 60 inches, with most of the precipitation falling as snow in the winter months (Western Regional Climate Center). Seasonal hydrographs are unavailable for these basins; however, based on elevation and precipitation regimes, peak stream flows would be expected to result from spring and summer snowmelt with occasional peaks generated by rain and rain-on-snow events.

Debris flows dominate channel and valley morphology for some streams in this area; however, the eleven streams addressed in this section do not exhibit frequent debris flows.

Peak flows for various return periods were estimated for each of the eleven basins using USGS regional regression equations (Curran et al. 2003), the SCS Unit Hydrograph Method (SCS 1984), and the Rational Method. For the reasons discussed below, peak flow estimates generated from the regional regression equations are believed to be the most appropriate for stream crossing design purposes.

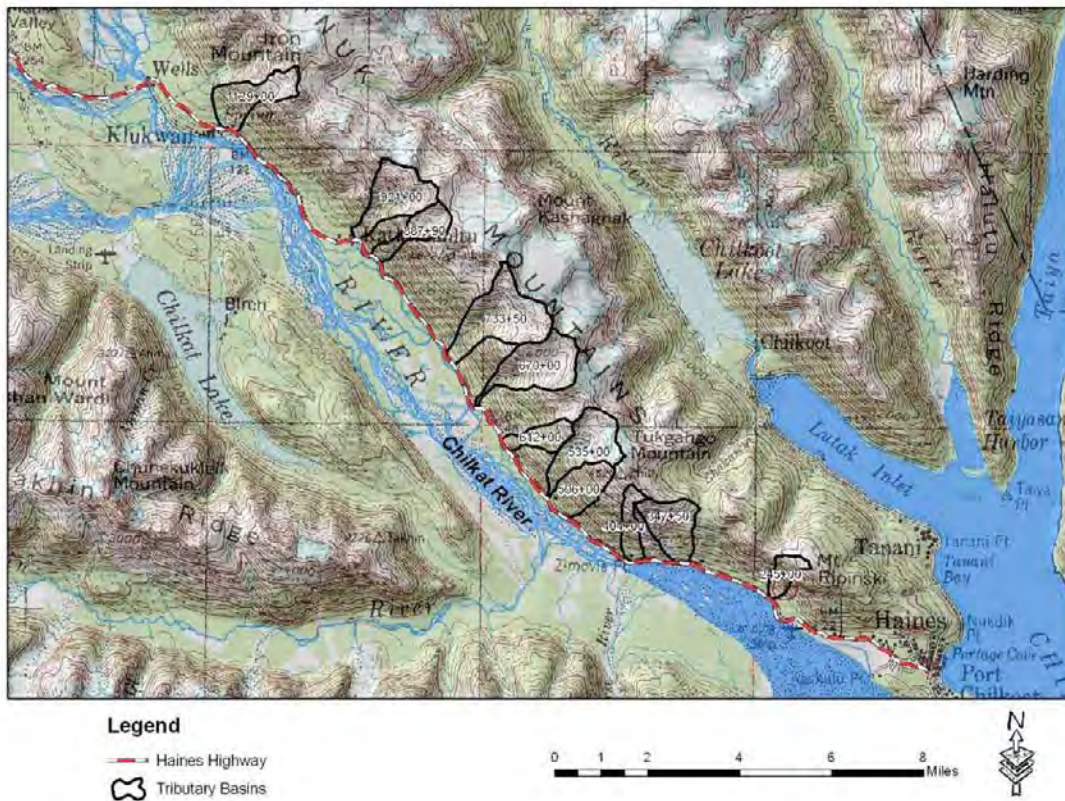

Figure 1. Map of Tributary Basins.

3.3.2.2 Regional Regression Analysis

The regression equations for southeast Alaska utilize drainage area (A), storage (ST), mean annual precipitation (P), and mean minimum January temperature (J) as predictor variables. Curran et al. (2003) used stream flow data from a total of 93 gaging stations to develop the regression equations. The equations and accuracy information are displayed in Table 3-1. Drainage area for each tributary basin was obtained by manually digitizing watershed boundaries on USGS 1:24,000 (7.5 minute) topographic maps in a Geographic Information System (GIS). Percent storage for each basin was obtained in GIS by digitizing surface water areas on the topographic maps. Mean minimum January temperature was obtained from values mapped by Jones and Fahl (1994). Values for basins located between isothermal lines were estimated through visual interpolation.

Mean annual precipitation values were obtained in GIS using a digitized version of the Jones and Fahl (1994) annual precipitation map - all of the basins fall within the 60 inch annual precipitation zone. **It should be noted, however, that this precipitation value is higher than actual annual precipitation measurements at Haines of 47.77 inches based on a period of record from June 1973 through December 2005 (Western Regional Climate Center).**

Table 3-1. USGS Regional Regression equations for estimating flood magnitude for various recurrence intervals. Equations are applicable to southeast Alaska (Curran et al. 2003).

Regression Equation for Specified Recurrence Interval (93 gaging stations)	Average standard error of prediction (percent)	Average equivalent years of record*
$Q_2 = 0.004119 A^{0.8361} (ST+1)^{-0.3590} P^{0.9110} (J+32)^{1.635}$	38	0.88
$Q_5 = 0.009024 A^{0.8322} (ST+1)^{-0.3670} P^{0.8128} (J+32)^{1.640}$	37	1.3
$Q_{10} = 0.01450 A^{0.8306} (ST+1)^{-0.3691} P^{0.7655} (J+32)^{1.622}$	37	1.8
$Q_{25} = 0.02522 A^{0.8292} (ST+1)^{-0.3697} P^{0.7165} (J+32)^{1.588}$	38	2.4
$Q_{50} = 0.03711 A^{0.8286} (ST+1)^{-0.3693} P^{0.6847} (J+32)^{1.559}$	40	2.8
$Q_{100} = 0.05364 A^{0.8281} (ST+1)^{-0.3683} P^{0.6556} (J+32)^{1.527}$	41	3.1
$Q_{200} = 0.07658 A^{0.8276} (ST+1)^{-0.3669} P^{0.6284} (J+32)^{1.495}$	43	3.4
$Q_{500} = 0.1209 A^{0.8272} (ST+1)^{-0.3646} P^{0.5948} (J+32)^{1.449}$	45	3.6

A=drainage area, in square miles; ST= area of lakes and ponds (storage), in percent; P=mean annual precipitation, in inches; J=mean minimum January temperature, in degrees Fahrenheit

Applicable range of variables: A: 0.720-571; ST: 0-26; P: 70-300; J: 0-32

**The number of years of systematic stream flow data that would have to be collected for a given site to estimate the stream flow statistic with accuracy equivalent to the estimate from the regression equation*

Basin characteristics for the eleven basins were within the range of values used to develop the regression equations with a number of exceptions. Three of the basins had drainage areas below the range; the smallest of which has a drainage area of 0.466 mi² compared to the range of 0.720 – 571 mi². According to the Jones and Fahl (1994) precipitation map, all of the basins have a mean annual precipitation of 60 inches, compared to the range of 70 – 300 inches. The violation of these criteria will affect the accuracy of the flow predictions. In general, the 11 tributary basins are smaller, lower elevation, drier, and warmer than the basins used to generate the regression equations. The study basins may exhibit proportionally larger peak flows than the basins used to generate the regression equations because of quicker times of concentration (less attenuation) due to high gradient and small size. Actual peak flow volumes could also be lower than those reported if precipitation levels are closer to the 47.77 inches measured at Haines, compared to the 60 inches reported by Jones and Fahl (1994).

Compared to the SCS Unit Hydrograph Method and the Rational Method, the regional regression equations are believed to represent the most appropriate flow estimates for

design purposes. The regression estimates are included in Table 3-2. Estimates from the SCS and Rational Method are presented in Appendix, Section 23.2.

Table 3-2. Flow estimates for tributary basins using USGS Regional Regression Equations (Curran et al. 2003).

Station ID	Drainage Area (mi ²)	40% of 2-year flood ¹	Flow Estimate for Indicated Return Period (ft ³ /second)							
			2	5	10	25	50	100	200	500
222+51	0.47	17	42	64	79	99	114	130	147	171
319+13	0.60	20	50	75	93	117	135	154	175	202
324+79	1.23	37	92	137	169	212	246	280	317	368
483+18	1.07	30	76	113	139	175	203	232	263	305
512+30	1.46	29	73	107	130	166	193	220	250	290
589+20	0.65	21	52	78	96	121	140	160	181	210
647+20	1.75	38	96	142	174	220	255	291	331	384
710+70	2.26	50	125	186	228	288	334	381	432	502
865+88	0.80	22	55	82	101	127	148	169	192	224
887+60	1.55	38	95	141	175	219	255	291	331	385
1102+19	1.26	29	73	109	135	170	198	227	258	301

¹Interim fish passage design flow (ADFG/ADOT&PF Memorandum of Agreement 2001)

3.3.2.3 SCS Unit Hydrograph Method

The SCS (now NRCS-Natural Resources Conservation Service) Unit Hydrograph Method (SCS 1984) was also applied to these 11 basins. The SCS Method calculates the volume of runoff per area of the basin according to soil and land use conditions. Information on time of concentration of stream flow and initial abstraction of storm precipitation are then used to calculate a unit hydrograph, which is applied to the runoff volume to calculate peak flow rates (SCS 1984). The hydrologic soil group was obtained in GIS using the NRCS State Soil Geographic (STATSGO) layer (NRCS 1979). The hydrologic soil group and land use conditions were then used to determine runoff curve numbers, which for all the basins were estimated at a value of 79. Time of concentration was obtained using flow length and average watershed slope, according to the procedures described for the method. Flow lengths were obtained in GIS by measuring the flow path from the stream outlet to the watershed divide using digitized versions of the USGS 7.5 minute topographic maps. Average watershed slopes were obtained by performing map calculations on the 30-meter Digital Elevation Models (DEMs) for the basins.

Basin characteristics yielded values outside the range for the initial abstraction to precipitation ratio that is used in the model. This is due to high intensity storms and low permeability soils. These results suggest that conditions in the study basins are outside the range of basin characteristics used to develop the SCS Method, which is primarily geared towards lowland agricultural basins. Final runoff volumes were substantially higher than those predicted with the regional regression equations. For these reasons, the SCS Method values were considered unreasonable estimates and were not incorporated into the final estimates for design flow. SCS Method flow estimates can be found in Appendix, Section 23.2.

3.3.2.4 *Rational Method*

The Rational Method was also applied to the study basins. The rational method simply uses rainfall intensity, watershed area, and a runoff coefficient to predict peak flow levels. Rainfall intensities for the 1-hour storm were used due to the short times of concentration of the basins. A runoff coefficient of 0.25 was selected based on watershed slopes and hydrologic soil groups. The Rational Method is best suited for small urban catchments and results for larger, rural basins should be viewed with caution. Nevertheless, the peak flow estimates are similar to the regional regression estimates, though slightly lower on average. These values are not used as recommended design flows because of the violation of basin size criteria specified in the Alaska Highway Drainage Manual (ADOT&PF, 1995), but they do increase confidence in the regional regression estimates because of their similar magnitude. Rational Method flow estimates can be found in Appendix, Section 23.2.

4. Chilkat River

4.1 Introduction

The project reach extends from highway milepost 3.5 to 25.3. The highway runs roughly parallel with the Chilkat River, crossing at the Wells Bridge near milepost 25.

The Chilkat River is a large, glacial fed river. Drainage area at the Wells Bridge is 791-square miles. Near the Haines airport the drainage area increases to 1,602-square miles. The Chilkat River varies in width from about 1,000-ft up to 1.1-miles near the airport. Bed materials range from silt/sand at the mouth to gravel/cobble near the upstream end of the study area. The active river channels shift dramatically over a short time period. From the mouth to milepost 10 the main stem parallels and fronts much of the highway. From milepost 10 to 19 there are a number of side channels and back water sloughs near the highway. A map of the Chilkat River watershed is included in Figure 2.

This study addresses, at a conceptual level, erosion protection of the highway embankment adjacent to the Chilkat River or its side channels. Included are estimates of depths of scour through field investigations and analysis. Further, incorporation of habitat while providing engineered stability to the highway is addressed.

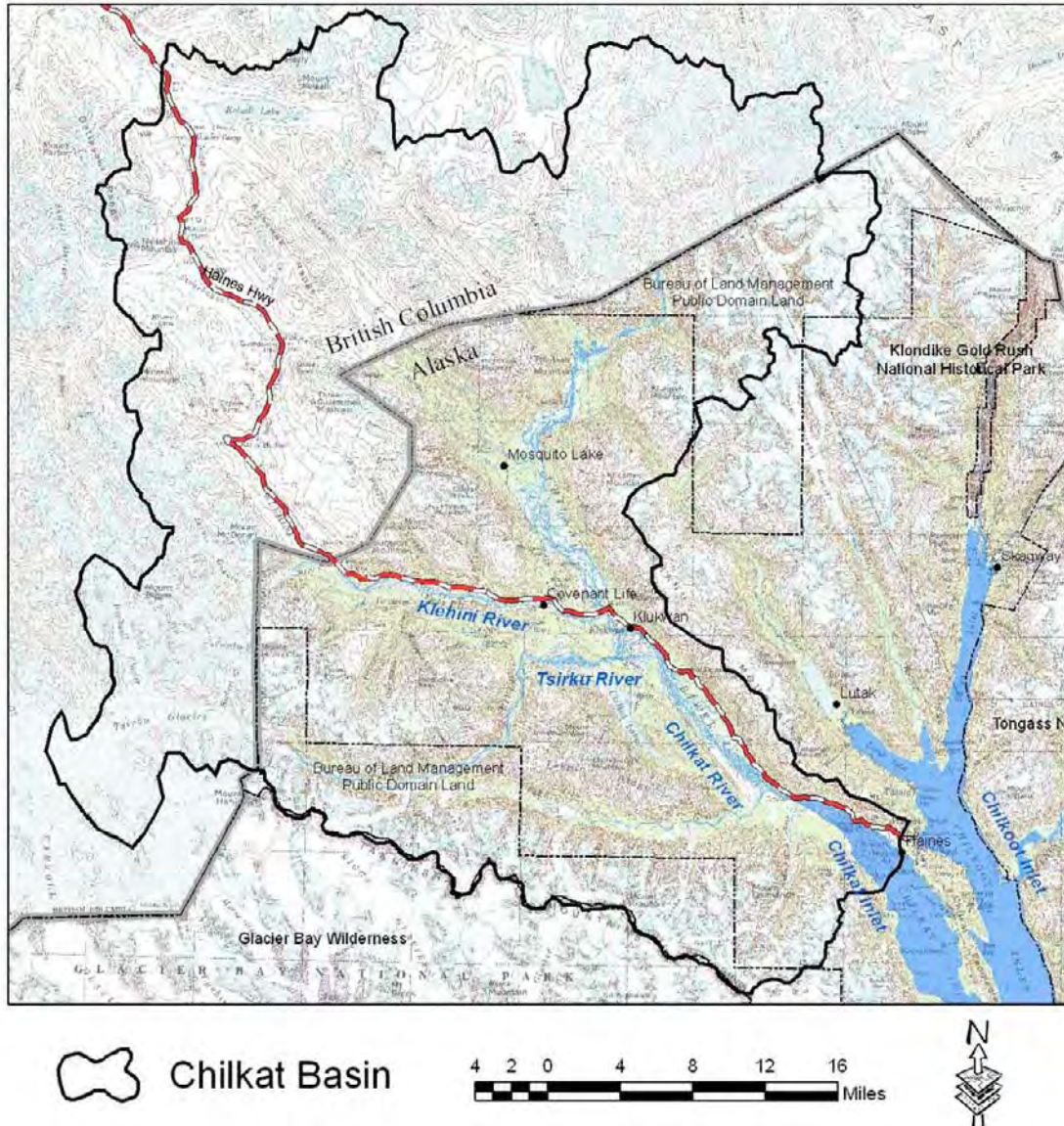

Figure 2. Map of the Chilkat Basin.

4.2 Chilkat River Field Investigations

Field investigations of the Chilkat River included visual inspection of existing roadway embankments, revetment and vegetation conditions, and estimates of existing scour depth conditions. Main areas of concern along the Chilkat River included reaches where the Chilkat River makes moderate to sharp bends, where points of land jut into the river and side channels of the Chilkat River impinge directly on the highway embankment.

4.2.1 Chilkat River Main Stem

Scour investigations were based on depth sounder measurements of scour holes along the main stem and side channels: An 18.5-ft jet boat was used to access portions of the main

stem of the Chilkat River. An Eagle, SuperPro ID portable depth sounder was attached to the boat to estimate depths to bottom. The depth sounder readings were periodically compared against depths manually probed with a rod to develop a correction factor. Typical areas where river scour were expected to occur were investigated by slowly ferrying across the river, depth sounder readings were called out and noted on site aerial photos. These depth readings are likely accurate to no better than 1- to 2-ft. Reading distance from shore was visually estimated and likely accurate to no better than 5- to 10-ft. The objective was to gain an understanding of relative magnitude of scour at different river conditions.

ADF&G maintains a staff gage near highway Station 395+00 (S&HI station 418+00) as noted in Section 4.3.1. At the time of the boat based investigations, the staff gage read approximately 29.03-ft elevation. No river flow information is associated with elevation readings.

Depths measured on October 7, 2005 ranged from 2- to 3-ft along straight wide sections to as deep as 15.5-ft in areas of bends and obstructions. Specific areas noted to have deep scour holes include:

- Off a point of land near Station 315+00 (S&HI station 338+00) scour depths range from 9- to 15.5-ft approximately 25-ft from shore.
- Near Station 394+00 (S&HI station 417+00), scour depths range from 8- to 14-ft with maximum depth about 30-ft from shore.
- Near Station 454+00 (S&HI station 477+00) above the lower ADF&G fish wheel flow depths are between 4.5 and 6.0-ft deep, evidence of little scouring along this locally straight reach.
- Near Station 462+00 (S&HI station 485+00) above the upper ADF&G fish wheel flow depths range from 6.0- to 9.5-ft. Flows impinge on the road embankment at the outside of a bend.

Scour conditions appeared to be localized at predictable locations, yet extend for several hundred feet in an upstream-downstream direction. It is anticipated that the location of scour holes will change dramatically in response to flood conditions and changes in channel plan form. It must be noted that scour holes typically reach their greatest depth at or shortly before a flood peak. As the flood recedes, bed load begins to deposit in the scour hole, reducing the depth observed following the flood. Thus, the maximum depth of scour during floods is typically greater than those observed following the flood. Maximum depths of scour during flooding vary dependent on a number of factors including magnitude of flood, rate of flow increase/decrease, debris, sediment and water temperature.

During the boat based investigations, visual observations were made of the existing riprap revetment and adjacent vegetative condition. In general, the existing rock along the main stem of the Chilkat River appeared to be performing satisfactorily for erosion protection. Woody vegetation growth was typically vigorous above a well-defined elevation on the bank and sporadic or absent below this elevation.

4.2.2 Chilkat River Side Channel

Side channels impinge directly on the highway and turn away at sharp angles; notably near stations: 640+00, 703+00, 751+00, 816+00 and 830+00 (S&HI stations 663+00, 724+00, 772+00, 837+00 and 851+00, respectively). Depth of scour at sharp bends along side channels impinging on the highway were also investigated by jet boat, where accessible, using the portable depth sounder. Areas inaccessible to the jet boat were investigated with the portable depth sounder and floating boom. The transducer was taped to a crab pot buoy which was attached to the end of a 14-ft long aluminum pruning saw handle. The 15-ft long depth sounder cable allowed readings to be taken from a wadeable depth along shore to a distance of about 15-ft into the channel. A guy line attached to the buoy was held from an upstream location to maintain the boom in position in areas of higher flow velocities. The boom was manually extended out from the bank and depth soundings read off and recorded. These depth readings are likely accurate to no better than 1- to 2-ft. Distance from shore was estimated in relation to reference marks along the pole and likely accurate to 1- to 3-ft. The objective was to gain an understanding of relative magnitude of scour at sharp bends.

Depths measured along the side channels on October 7 and 8, 2005 ranged from 4-ft along straight sections to as deep as 12-ft at sharp bends. Specific areas noted to have deep scour holes include:

- At a bend in the side channel near Station 623+00 (S&HI station 646+00) depths range from 4- to 9.5-ft.
- At a sharp bend in the side channel near Station 640+00 (S&HI station 663+00) depths range from 6- to 11-ft.
- Along a straight reach of the side channel from Station 672+00 to 699+00 (S&HI stations 693+00 and 720+00, respectively) depths range from 4- to 9.5-ft. Average depths appear to range from 5- to 6-ft.
- At a bend in the side channel near Station 703+00 (S&HI station 724+00) depths range from 6.5- to 11-ft. Deepest scour appears to occur approximately 10- to 15-ft off shore.
- At a bend in the side channel near Station 751+00 (S&HI station 772+00) depths range from 6- to 9-ft.
- At bends in a minor side channel near Stations 816+00 and 830+00 (S&HI stations 837+00 and 851+00, respectively) scour depths range from 6- to 11-ft deep.

Scour conditions appeared to be localized at predictable locations yet extend for a few hundred feet in the upstream-downstream direction. Commonly, vegetated banks opposite the highway dropped vertically 7- to 8-ft below water level to the stream bottom. Trees toppled into the channel are not uncommon along these locations. As noted earlier, scour holes typically reach their greatest depth at or shortly before a flood peak. As the flood recedes, bed load begins to deposit in the scour hole, reducing the depth observed following the flood. Depths of scour during floods are expected to be greater than those observed following the flood event.

Visual observations of riprap conditions along the side channels indicated that the majority of the existing rock was in satisfactory condition. Some erosion was noted along the bank where the rock was small, banks were steep, and flow impingement most likely. These areas were located at: 700+50-704+00, 750+00-752+00, and 777+00-779+00 (S&HI stations 721+50-725+00, 771+00-771+00, and 798+00-800+00, respectively). Areas of vegetated riprap generally appeared to be in satisfactory condition for erosion protection. Typically there is a distinct elevation of persistent vegetation with vigorous plant growth above and little to no plant growth below. These observable conditions provide useful guidelines for what is feasible for bioengineering solutions.

4.3 Hydraulic History

4.3.1 Tidal and Non-Tidal

Tidal range of the Lynn Canal at the Chilkat Inlet gage (6.9-miles southeast (true) of the Haines airport) is 16.5-ft between mean lower low water (MLLW) and mean higher high water (MHHW) (<http://www.co-ops.nos.noaa.gov/benchmarks/9452421.html>).

An inquiry was submitted to ADOT&PF surveyors regarding conversion from the tidal datum to land based elevation datum. The following response was provided (T. Reed, personal communication May 22, 2006):

“ADOT&PF has benchmark ties to the NAVD 88 datum in the Haines area for the subject project. Based on other ADOT&PF survey work (specifically GPS ties to tidal benchmarks at Taiyasanka Harbor, AK station 9452434) in the area a conversion from tidal to NAVD 88 datum was determined to be NAVD 88 + 7.4-ft = MLLW tidal datum. MHHW tide elevation along the Chilkat Inlet is 16.76-ft (MLLW). This elevation converted to NAVD 88 is approximately 9.4-ft (NAVD 88). Based on existing conditions LIDAR topographic mapping, elevation 14.7-ft (NAVD 88) occurs along the Chilkat River sand flats at the downstream end of the Haines Airport, downstream of the project beginning. The lowest LIDAR elevation observed at the upper end of the runway is 17.3-ft NAVD88.”

The extent of tidal influence along the Chilkat River was approximately estimated by extrapolating the HEC-RAS model developed for the scour hole at station 394+00 (S&HI station 417+00) to downstream from the airport. The most downstream cross section synthesized for the Station 394+00 (S&HI station 417+00) outcropping was copied downstream to the airport and also copied to 14,045-ft downstream of the airport to the end of the flats indicated on the USGS topographic map. The elevations of these cross sections were adjusted based on the LIDAR contour elevation (14-ft) at the airport and at the downstream end of the flats based on extrapolation of the lower LIDAR coverage. Though extremely approximate in nature, this provided a rough comparison of water surface elevations generated along the river with the one-dimensional HEC-RAS model and MHHW. From this modeling it was seen that the elevation of MHHW is lower than the flood water surface elevation for the 2- through 100-year events that were considered in the model. Therefore, high tide will not have a hydraulic affect on river

during the 2-year or higher flows. Results of the approximate HEC-RAS model are shown in Appendix 23.5.1.

Fluctuations in the Chilkat River discharge and associated water surface elevations will affect the project and backwater many of the tributary crossings of the highway. Typical summer water level fluctuations are observed at a staff gage maintained and monitored by ADF&G near station 395+00 (S&HI station 418+00). The gage has been read for a period of record from 1994 through 2005 from June through September or October. The gage readings include only water surface elevation. The top of the piling elevation, 36.185-ft, was surveyed by ADOT&PF in 2005 with the associated staff gage elevations subsequently tied to that temporary bench mark elevation (M. Sogge, personal communication, Sept 2006). River water surface levels range from about 31.0- to 33.0-ft for June through July. Levels begin to decrease starting in August. In September the river levels range from an average low of about 29.0- to 31.5-ft. September minimum water levels are about 28.5-ft while maximum values are about 33.5-ft. These levels reflect the impact of fall rains. No river discharge measurements or calculations are associated with these stage data. A chart of these data are provided in Figure 3

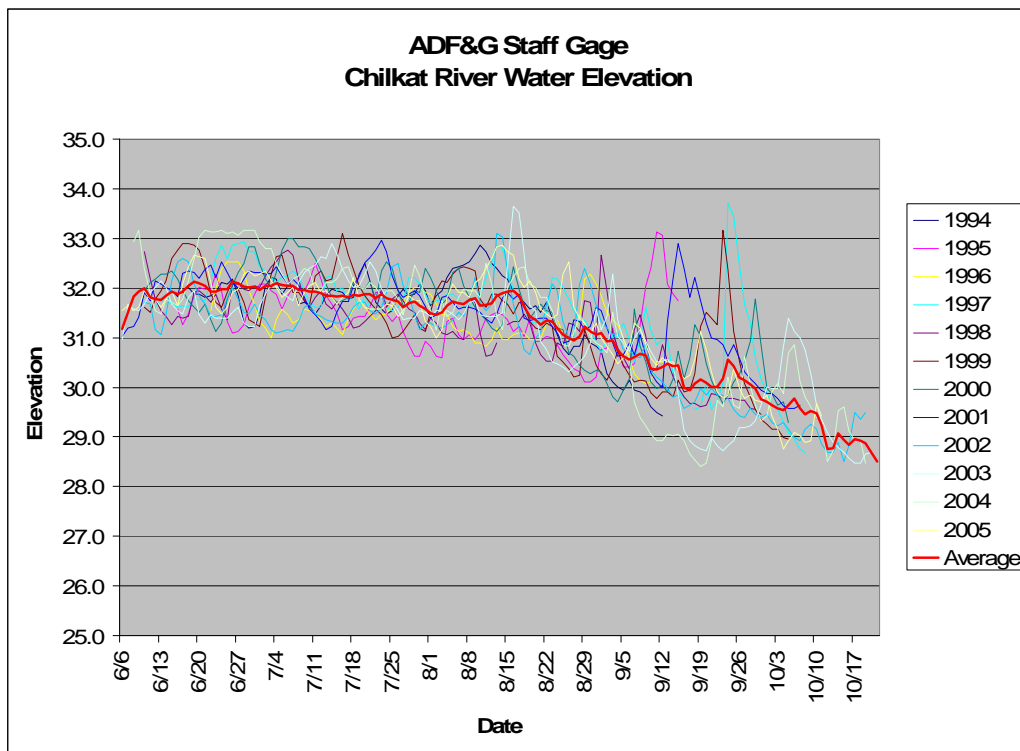

Figure 3. ADF&G staff gage readings near Sta 395+00

4.3.2 Navigation

Navigation is limited to recreational, commercial tour and ADF&G research jet boat use along the length of the project. In addition, commercial raft float trips are conducted from the Tsirku River through the Chilkat Bald Eagle Preserve to about milepost 15.

Recreational canoes, kayaks and rafts are also used along the river. The Chilkat River dynamically shifts its course with extensive gravel bars, shallow flow depths over riffles and extensive sand and silt flats. Other than tourism and sport and subsistence fishing, little commercial activity presently occurs along the Chilkat River. Therefore, no other navigational use is anticipated.

4.3.3 Confluence

The Chilkat River discharges to the Chilkat Inlet of Lynn Canal. Within the project reach, the Chilkat River has confluences with the Kicking Horse River, the Tahkin River, the Tsirku River and the Klehini River. All these rivers discharge into the Chilkat River from the southwest side, opposite the highway. No impact is foreseen to these confluences by the proposed action.

4.3.4 Mining

Approximately 500,000-cy of gravel was mined from the river near the Haines airport runway during the winter of 1990-91 for construction of the Haines airport. Otherwise, mining activity within the Chilkat River has not been identified to exist. No in stream mining of gravel material is reportedly planned for this project.

Iron, gold, copper, platinum and palladium deposits exist within the Chilkat River watershed along the project length. However, economics have not justified mining these deposits. No plans for mining these deposits are publicly available. (M. Sogge, personal communication)

4.3.5 Debris and Icing Problems

Debris load along the Chilkat River consists of large woody debris load typical of this scale of southeast Alaskan glacial rivers. This debris forms occasional logjams but has not been observed to have a significant impact on the Haines Highway.

The timing of ice-up of the Chilkat River depends on the severity of the winter. In general, there is a section of the river near the Tsirku River alluvial fan that remains open at least through November, but more often December. There have been many times around Christmas when the river has been observed to be open between 19 mile and the Wells Bridge. It is not uncommon for most of the river to freeze over in January and February. Channels of the river can open up in March, but the main breakup does not typically occur until the beginning of April. (M. Sogge, personal communication)

Glaciers occupy approximately 20 percent of the upper watershed (based on the 1:250,000 USGS map). Glaciers do not directly encroach into the project area. No glacial outburst flooding was recalled in the anecdotal record. USGS Atlas HA-455 (Post and Mayo, 1971) indicates no significant glacial outburst floods in the Chilkat River Basin. Glacial outburst flooding from the headwaters of the Tsirku River is implied by hatch pattern on Sheet 1 in the Post and Mayo report. However, there is no discussion of

the Tsirku River in the report. The Tsirku River discharges into the Chilkat River opposite the village of Klukwan. Based on the anecdotal record and cursory reference in the Post and Mayo report, it is assumed that glacial outburst flooding has insignificant influence on flows along the Chilkat River.

4.3.6 Geomorphology

Geomorphology of the Chilkat River can be characterized as a large dynamic glacially fed river. The river is braided throughout the project length and the active flow path shifts significantly and dramatically over short time periods; typically in response to higher magnitude and longer duration flows. As an anecdotal example, along a side channel adjacent to the road near milepost 14, an exposed sand bar observed in 1999 by Inter-Fluve was absent and found to be replaced by a 12-ft deep scour hole during the October 2005 field investigation. The braided main stem is adjacent to the road or separated by a narrow band of forest from the Haines airport to milepost 10. From milepost 10 to 19, there is a complex system of side channels close to the road with the main river further from the road. Along the project length, the Klehini, Tsirku, Takhin and Kicking Horse Rivers are tributary to the Chilkat River entering from the southwest side opposite the highway.

4.3.7 Bed Load

Based on ocular investigation, bed load varies in size from sands and silts near the downstream end, transitioning to gravels and cobbles at the Wells Bridge near milepost 25. Above the Wells Bridge, the Chilkat River widens with extensive sand bars noted.

4.3.8 Environmental

Environmental considerations along the Chilkat River include the presence of Chinook, coho, pink, chum and sockeye salmon, eulachon and bald eagles. Proposed bank revetments strive to maximize the use of habitat elements while maintaining engineered stability.

4.4 Hydrology

The Chilkat River originates in the Datlasaka and Kusawak Mountains of northwest coastal British Columbia, flows into northern southeast Alaska, and empties into the Chilkat Inlet branch of the Lynn Canal near Haines, AK. Total basin size is approximately 1,600 square miles; just over half (54 percent) lying within the United States. Major tributaries include the Kellsall River, the Klehini River, the Tsirku River, and the Takhin River. Elevations in the basin range from sea level at the mouth to approximately 9,000 feet in the headwaters of the Tsirku Basin. Precipitation is snow-dominated with summer rains common in the lower elevations. The higher elevations are covered with expansive glaciers. The main stem and major tributaries exhibit a glacial melt water hydrologic regime, with peak flows typically occurring in the early summer

(snowmelt) or in late summer/early fall (rain plus snowmelt). Low flows typically occur during winter months. Occasional large peak flows result from rain-on-snow events.

Flood frequency analysis was conducted for five locations along the main stem Chilkat River. Flow estimates were made for various return periods in support of channel hydraulic assessments at various locations where the main stem Chilkat or major side channels flow adjacent to the Haines Highway. Flow estimates are for the entire Chilkat River and do not account for flow separation into branching channels.

Peak flow estimates for various return periods were estimated using a combination of USGS regional regression equations (Curran et al. 2003) and watershed expansion of nearby available gage data. Nearby gages used in the watershed expansion include the Klehini Gage (USGS Station #15056560) and the Upper Chilkat Gage (USGS #15056400).

4.4.1 Regional Regression Analysis

The regression equations for southeast Alaska utilize drainage area (A), storage (ST), mean annual precipitation (P), and mean minimum January temperature (J) as predictor variables. Curran et al. (2003) used stream flow data from a total of 93 gaging stations to develop the equations. The equations and accuracy information are displayed in Table 3-1. Basin delineations were performed manually in a Geographic Information System (GIS) using the USGS 1:250,000 topographical map (Skagway) and shaded relief images derived from 30-meter Digital Elevation Models (DEMs). Percent storage for each basin was obtained in GIS by digitizing surface water areas on topographic maps. Mean annual precipitation values were obtained in GIS using a digitized version of the Jones and Fahl (1994) annual precipitation map. Average precipitation values for each basin were weighted by the amount of area in each precipitation zone. Precipitation zones were not available for the Canadian portions of the basins; US data was therefore proportionally expanded into the Canadian portion. Mean minimum January temperature was obtained by geo-referencing and digitizing the temperature isothermal map in Jones and Fahl (1994). Average temperature values for each basin were weighted by the amount of area in each temperature zone. The regression estimates for the main stem Chilkat are included in Table 4-2.

4.4.2 Watershed Expansion Using Gage Data

Flow records are available for several years at two locations in the Chilkat Basin. These include the Upper Chilkat Gage (1962-1968) and the Klehini Gage (1982-1993). Curran et al. (2003) recommend a procedure for estimating peak flows where gage data is available. The method involves conducting Log Pearson III analysis on the gage data and weighting these results with those obtained using regional regression equations. Weighting is conducted according to the number of years of record of gage data and the Equivalent Years of Record (EYR) of the regression equation. This analysis was conducted by Curran et al. (2003) for many streams in Alaska, including the Klehini. The values for the Klehini included in Table 4-2 were obtained by expanding the reported Klehini values to the basins of interest.

Curran et al. (2003) performed stream flow analysis for stations with at least eight years of record and therefore did not perform analysis for the Upper Chilkat Gage, which has seven years of peak flow records. The procedure they describe, however, is suitable for stations with as few as five years of record due to the weighting with regression equations. Their procedure was therefore performed for the Upper Chilkat Gage location in order to obtain additional data points for final peak flow estimates.

A Log Pearson Type III analysis was first performed on the gage data following the methods described in Bulletin 17B of the IACW (1982). Instantaneous peaks were used for all years except one, where only the average daily peak was available. A weighted skew coefficient was obtained by weighting the derived station skew with the generalized skew for southeast Alaska using the procedures described in Curran et al. (2003). The values obtained through Log Pearson III analysis are included in Table 4-1. Regional regression analysis was then performed for the station location. The Log Pearson III values and the regression values were weighted using the following equation from Curran et al. (2003):

$$\log Q_{T_{wtd}} = \frac{\log Q_{T_{sta}}N + \log Q_{T_{reg}}EYR}{N + EYR}$$

where $Q_{T_{wtd}}$ is the weighted peak flow estimate, $Q_{T_{sta}}$ is the value obtained from the Log Pearson III analysis with weighted skew, $Q_{T_{reg}}$ is the value obtained using the regional regression equation, N is the number of years of record of station data, and EYR is the Equivalent Years of Record for the regional regression equation. The weighted flow estimates for the Chilkat Gage location are included in Table 4-1.

Table 4-1. Results of flow calculations for the Upper Chilkat Gage location using Log Pearson Type III Analysis and USGS regional regression equations.

Return Period	Log Pearson III		Regional Regression		Weighted Q (ft ³ /second)
	Q (ft ³ /second)	Years of Record (Gage)	Q (ft ³ /second)	Equivalent Years of Record ¹	
2	8,985	7	6,521	0.88	8,669
5	12,712	7	8,880	1.30	12,017
10	15,649	7	10,485	1.80	14,418
25	19,949	7	12,922	2.40	17,856
50	23,610	7	14,766	2.80	20,647
100	27,697	7	16,633	3.10	23,684
200	32,269	7	18,678	3.40	26,987

¹ From Curran et al. (2003)

4.4.3 Final Flow Estimates

In order to obtain final flood flow estimates, values from the following analyses were averaged: 1) regional regression, 2) watershed expansion using Klehini Gage, and 3) watershed expansion using Upper Chilkat Gage. All of these results are included in Table 4-2.

Table 4-2. Final flow estimates for locations along the lower mainstem Chilkat River. Values in cubic feet per second.

Return Period	Chilkat at Mouth (1,602 mi²)	Chilkat below Tahkin River (1,526 mi²)	Chilkat below Tsirku River (1,364 mi²)	Chilkat below Klehini River (1,080 mi²)	Chilkat above Klehini River (791 mi²)
2-Year					
Regional Regression	32,837	30,932	25,465	18,327	12,375
Klehini Expansion	40,106	38,204	34,148	27,038	19,803
Upper Chilkat Expansion	57,869	55,123	49,272	39,013	28,573
Average	43,604	41,420	36,295	28,126	20,250
5-Year					
Regional Regression	45,167	42,552	35,173	25,506	17,260
Klehini Expansion	47,327	45,081	40,296	31,906	23,368
Upper Chilkat Expansion	80,213	76,408	68,297	54,076	39,606
Average	57,569	54,681	47,922	37,163	26,745
10-Year					
Regional Regression	53,375	50,300	41,637	30,368	20,523
Klehini Expansion	51,839	49,380	44,138	34,948	25,596
Upper Chilkat Expansion	96,242	91,677	81,944	64,882	47,520
Average	67,152	63,786	55,906	43,399	31,213
25-Year					
Regional Regression	66,004	62,231	51,731	37,896	25,763
Klehini Expansion	57,537	54,807	48,989	38,789	28,409
Upper Chilkat Expansion	119,186	113,532	101,479	80,350	58,849
Average	80,909	76,856	67,399	52,345	37,674
50-Year					
Regional Regression	75,469	71,180	59,301	43,610	29,708
Klehini Expansion	61,485	58,568	52,351	41,451	30,359
Upper Chilkat Expansion	137,818	131,280	117,343	92,911	68,049
Average	91,591	87,010	76,332	59,324	42,705
100-Year					
Regional Regression	85,007	80,209	66,969	49,436	33,748
Klehini Expansion	65,434	62,330	55,713	44,113	32,308
Upper Chilkat Expansion	158,093	150,593	134,606	106,579	78,060
Average	102,845	97,710	85,763	66,710	48,039
200-Year					
Regional Regression	95,425	90,074	75,366	55,839	38,200
Klehini Expansion	69,382	66,091	59,075	46,775	34,258
Upper Chilkat Expansion	180,138	171,592	153,376	121,441	88,944
Average	114,982	109,252	95,939	74,685	53,801

4.5 Local input

The Haines area ADOT&PF maintenance supervisor, Roger Ingledue, was interviewed about existing conditions, past performance and areas of concern. In general, the existing Chilkat River and Haines Highway system was reported to be functioning satisfactorily. No flood overtopping of the road either by the Chilkat River main stem or side channels or tributary crossings along the project reach was reported. Overtopping of the road by some tributaries during the November 2005 flood was reported in cases where the culverts were blocked by debris or sediment. No problems with icing were recalled. And no problem areas of revetment erosion were noted.

A flood occurred in November, 2005 that caused sediment and debris accumulations in some tributaries that blocked culverts. Mr. Ingledue reported that flows overtopping the road during the November 2005 flood were a result of debris and sediment plugging the culvert. No overtopping was reported at culverts that were not obstructed. (Personal communication to Mark Sogge, Inter-Fluve, March 8, 2006)

4.6 Backwater

4.6.1 Main stem

No FEMA Flood Insurance Studies were located for the Chilkat River. Anecdotal information indicates that this stretch of highway has not been overtopped during the period of record, since about 1980. Reports of overtopping of the highway during the November 2005 flood were determined to be mountainside flows blocked by sediment and debris accumulations at culvert inlets and subsequently overtopping the road.

The hydraulic and geomorphic conditions of this river and system of side channels are extremely dynamic and complex. The Chilkat River is a braided sand, gravel and cobble bed river with rapidly changing active channels. An extensive sand flats area is located at the mouth where the sediment load deposits as the Chilkat River enters the tidal Lynn Canal. Existing data consists of LIDAR coverage along the highway corridor extending up to approximately one-third, but no more than 1,000-ft, across the active river. The LIDAR does not capture below water topography (bathymetry). The active river ranges from 1,000-ft to over a mile in width. USGS maps have a contour interval of 100-ft and are inadequate to extend the topographic coverage for the hydraulic analysis. Further, the USGS 1:63,360 topographic maps were created in 1954 and revised/inspected in 1977. In addition to the coarse resolution of the topography, it is impacted by isostatic rebound anecdotally reported to be approximately 0.9-inches/year as noted in Section 4.9. There is extremely limited availability of river flow-water surface elevation data for calibration of a hydraulic model.

Given the dynamic nature and complexity of the Chilkat River system and scale of the several miles of river paralleling the road; determination of a jurisdictional 100-year water surface elevation along the length of the project is beyond the scope of this study.

Therefore, an alternate approach was adopted for this conceptual level evaluation. This approximate approach is site specific to enable a semi-quantitative modeling approach for design values. In addition, the relative impact of the proposed action on water surface elevations can be approximated. For preliminary design of bank erosion protection and depth of scour, areas of greatest concern were considered. The area selected for this simplified approach was near Station 394+00 (S&HI station 417+00). A scour hole with depths to 15.5-ft is located at the outside of a bend in the river off a point of land. ADF&G maintains a seasonal staff gage near this location.

Model cross sections were approximately synthesized from the dearth of available data. The LIDAR surface topographic information was used in conjunction with depth sounder readings to approximate bathymetry. Active river width was approximated from the USGS topographic map with a southwest flood plain elevation assumed. Distance between sections was measured from the respective location of the sections superimposed on the LIDAR topography. Downstream boundary conditions were determined by normal depth calculations using a slope of 0.00066-ft/ft determined from the portion of LIDAR topography for the river. For this conceptual phase, values of Manning's n roughness coefficient were estimated based on engineering judgment. Values for the channel and overbank areas were 0.038 and 0.055, respectively.

To model proposed conditions, the existing conditions model was copied and modified to reflect a 2H:1V bank. Comparison of the existing and proposed conditions models indicates 0.02-ft of increase in elevation. However, it must be noted that the Chilkat River is dynamically changing location and bed form with corresponding changes in water surface elevations. Further, the model did not account for changes in cross sectional shape as silts/sands/gravels will transport and deposit in response to river flows.

As noted in Section 4.3.1, this model was used to approximately estimate the upstream limit of tidal influence. The downstream most cross section near station 394+00 (S&HI station 417+00) was copied to near the airport and the limit of the sand flats indicated on the USGS topographic map. Cross section elevations were adjusted based on LIDAR elevations at the airport and extrapolation to the edge of the sand flats. Low tide conditions were modeled using a normal depth as a downstream boundary condition. High tide conditions were modeled using MHHW converted to NAVD 88 project datum as a constant downstream water surface elevation boundary condition. The results of this approximate model indicated that high tide elevations are lower than river water surface elevations generated from the model using normal depth boundary conditions. Thus MHHW do not create a back water condition (hydraulic M1 curve) on river flows at the downstream end of the model below the Haines airport and do not impact the river hydraulics through the project reach.

Summary results from the modeling effort are included in Appendix 23.5.1.

4.6.2 Side Channels

A modeling approach similar to the main stem was taken for the side channels. Representative sites near Stations 640+00, 672+00 to 709+00, 749+00 and 792+00 (S&HI stations 663+00, 693+00, 730+00, 770+00, 813+00, respectively) were selected for evaluation. The LIDAR topographic data included the full side channel width at these locations. Boat and wading based depth sounding readings were used to synthesize below water portions of the cross section. Wading based depth soundings extended only partially across the side channel. Depths across the un-sounded width were extrapolated by assumption.

A range of flows were included in the model in an effort to determine the worst case condition for design of revetment and scour depth protection. As described in the preceding section, the river system is extremely dynamic and complex. The percent of flow diverting from the main Chilkat River along the side channel and flood plains is not known. Therefore, it is not possible to determine a return period event for the various flows.

Summary results from the modeling effort are included in Appendix 23.5.1.

4.7 Scour

As described in Section 4.2, areas where scour would be expected to occur were investigated using a portable depth sounder. These areas were accessed with a jet boat or by wading. These readings provide the scour conditions at the time of the field investigation; October 7 and 8, 2005. Floods typically form the deepest scour at or near the peak of the flood hydrograph. As the flood recedes, the scour hole begins to fill in with bed load. Therefore, maximum scour depth would be expected to be deeper than that measured in October.

4.7.1 Main Stem

Scour depths were observed using the jet boat and depth sounder. Locations of depth readings from the bank were noted by landmarks and visual estimates of distance from the bank. Readings and location were noted onto the project air photo. Main stem depths ranged from 2- to 3- feet in shallow straight riffles to scour holes with depths of 14- to 15.5-ft. Scour holes typically occurred at bends or points of land extending into the active flow path. Scour holes extended for several hundred feet in the upstream-downstream direction.

The Chilkat River system is highly dynamic with flow paths and channel geometry changing quickly and dramatically. As a result, the location, depth and mechanism of scour should be expected to change with scour depths in excess of observed values potentially occurring at nearly any location along the embankment.

4.7.2 Side Channels

Locations of scour holes along the side channels are likely to be more static in their location than those occurring within the main river channel. The scour holes were typically located at bends or local scour at obstructions. Observed scour depths ranged from 8- to 12-ft or more.

4.8 Hydraulic Design

4.8.1 Main Stem

Field observations and the results of the hydraulic modeling were used for conceptual design of road embankment protection. In the field it was noted that there was a distinct elevation on the bank of persistent woody vegetation. Woody vegetation was generally robust above this elevation. Below this elevation, the vegetation was either altogether absent or sporadic. This very obvious field indicator provides a guideline about the applicability of bioengineering techniques for erosion protection. Below this elevation rock is the most suitable material to provide the level of erosion protection required for the highway. Above this elevation, vegetation may provide a satisfactory measure for erosion protection. Non-living vegetation may be incorporated into the lower bank if properly designed for scour and stability of the road, road embankment, and materials. Concepts are shown in the drawings. Final design of these features will be completed at a later stage for submittal with Plans-in-Hand.

Rock to protect the lower bank was sized for flows up to the 100-year event based on bed tractive force, adjusted for increases if along a bend, using the moment stability method (Julien, 1995). The moment stability method accounts for the angularity and specific gravity of rock and provides results that compare well against conditions observed in the field. For relatively straight reaches an average rock size of 18-inches (sound and angular rock with a minimum specific gravity equal to 2.65) laid at a 2H:1V slope will be required. A layer of filter gravel (or fabric) will be required between the rock and the bank slope.

Scour depth is most accurately estimated from field observations. As noted in the preceding section, scour at bends and points of land jutting into the channel were observed in early October, 2005 to have depths to 15.5-ft. These depths will be greater during flood peaks. The observed scour holes occur in predictable isolated locations and tend to extend for several hundred feet in the upstream – downstream direction. Areas at higher risk of erosion include places where the river impinges the road embankment with flows turning at an angle or where land juts into the flow. Straight flow paths were observed to have flow depths of 3- to 6-ft deep with a relatively flat bed surface. However, the river is dynamic and continually changing flow path. Any portion of the road embankment may become subject to aggressive scour from river flows. Following project completion, monitoring and adaptive management of the road embankment is highly recommended.

From the hydraulic analysis, bed shears appear low enough that vegetation may perform satisfactorily for bank erosion protection above the field observed elevation of persistent woody vegetation. Basic concepts are included in the concept drawings. Details will be prepared at final design.

4.8.2 Side Channels

Similar to the main stem, field observations and the results of the hydraulic modeling were used for conceptual design of road embankment protection along the side channels of the Chilkat River. A distinct elevation of persistent woody vegetation was noted for side channels as well.

The side channels represent a complex network of flow paths. It was not possible without extensive topographic data and modeling efforts to determine the percentage of flow for each return period flood event that is conveyed along the side channels or flood plains. Therefore, a worst case condition, corresponding to bank full flow, was used as the design condition along the side channels. Flows greater than bank full are expected to spill onto the flood plain and dissipate the energy associated with the additional flow. Rock to protect the lower bank was sized for flows up to the worst case condition based on bed tractive force, and the moment stability method (Julien, 1995). A bend coefficient was used to account for greater shear forces along bends (FHWA, 1988). For sharp bends (e.g. Station 640+00 - S&HI station 663+00) the coefficient doubles the bed tractive force. The moment stability method accounts for the angularity of rock and provides results that compare well against conditions observed in the field. Average rock size of about 18-inch diameter will be required along straight reaches, below the tangent of bends. At moderate bends average rock size will need to be between 21- and 27-inches. At sharp bends with high tractive forces and turbulence, average rock size may need to be 30-inches and laid at 2.5H:1V or flatter. All rock is to be sound and angular with sizes based on a minimum specific gravity equal to 2.65. A layer of filter gravel (or fabric) will be required between the rock and the bank slope.

Scour depth is based on observations in the field. As noted in the preceding section, scour at bends and points of land jutting into the Chilkat side channels were observed in early October, 2005 to have depths to 11.5-ft. These depths will be greater during flood peaks. The scour holes occur in predictable isolated locations and tend to extend for a few hundred feet in the upstream – downstream direction. Areas at higher risk of erosion include outsides of bends. The severity of scour increases with tighter bends. Straight flow paths were observed to have flow depths of 4- to 6-ft deep with a relatively flat bed surface. Locations of scour are not expected to change from current locations. Fallen trees or debris accumulations will also initiate local scour. Following project completion, ongoing monitoring and adaptive management of the road embankment is highly recommended.

From the hydraulic analysis, bed shears appear low enough that vegetation may perform satisfactorily for bank erosion protection above the field observed elevation of persistent

woody vegetation. Basic concepts are included in the concept drawings. Details will be prepared at final design.

4.9 23 CFR

An internet search turned up no indication that a FEMA Flood Insurance Study exists for the Chilkat River. Communication with Haines Borough Planner Scott Hansen indicated that no FEMA Flood Insurance Study (FIS) is known to exist for the Chilkat River system. An FIS for the immediate Haines area dating back to the 1970's is available but is likely obsolete as isostatic rebound is anecdotally reported to be approximately 0.9-inches/year (S. Hansen, email communication).

As described in Section 4.6, representative conditions at Station 394+00 (S&HI station 417+00) were modeled to compare estimated water surface elevations associated with existing and with project conditions. The existing conditions run was copied and modified to represent bank conditions. There is 0.02-ft of increase in water surface elevation for the with-project condition. However, it must be noted that the river changes dynamically with shifting bed forms. Changes in cross section and flow roughness by these natural processes are anticipated to cause greater changes in water surface elevations. Further, the dynamic shifting of the river bed and bar forms will likely adjust in response to roadway encroachment. A detailed analysis of this bed shifting and corresponding adjustments to water surface elevations is beyond the scope of this study.

Risks associated with the proposed action are considered to be similar in scale to those of the existing roadway. The road embankment is subject to forces of the Chilkat River and changes in channel form, such as scour depths and locations. The existing road is subject to much the same forces. Through field observations and design calculations similar or greater levels of protection are an objective. Following project implementation monitoring and maintenance are recommended.

4.10 Conclusion

The hydraulic features of the proposed action have been developed to a conceptual level in support of permitting and environmental activities. The design features will be revised as appropriate and final designs and report will be prepared for the Plans-in-Hand submittal.

Conceptual designs of revetments follow industry standard methods. Bioengineering has no nationally established engineering design methods. Design of vegetative erosion protection is based on current knowledge in the industry and Inter-Fluve's experience from 1983 to the present in this field. Further, reference reach conditions are used as a design template.

4.11 Riprap

Existing riprap was observed to be mostly stable and reported to be performing satisfactorily. Hydraulic analysis was used to preliminarily size rock for road embankment erosion protection as described in Section 4.8.

4.12 Flood Hazard Area

The project is not located within a defined flood hazard area.

5. Culvert Replacement at Station 222+51

5.1 Introduction

The unnamed tributary crossing the highway at station 222+51 (S&HI station 245+50) is comprised of an existing circular 48-inch corrugated metal pipe (CMP). The bottom of the pipe is rusted and the pipe should be replaced. At this Preliminary Engineering Report phase, the pipe was preliminarily designed based on Tier 1 stream simulation fish passage design¹ methods outlined in the MOA. Tier 1 methods were selected based on the high quality of upstream habitats. This project will replace the existing pipe with a larger 6'-9" by 4'-11" pipe arch to convey flood flows and provide fish passage.

5.2 Hydraulic History

This unnamed tributary crosses the Haines Highway at about elevation 21-ft. As described in Section 4.3.1, MHHW is at elevation 9.4-ft (NAVD 88) and based on approximate modeling, tidal backwater will not extend to this location.

Field indicators of Chilkat River backwater (i.e. deposition of fine sediments) were not seen to extend upstream along the tributary to the location of the existing culvert. Therefore, it is not likely that the culvert is impacted by backwater effects from frequently occurring Chilkat River flows. Large Chilkat River floods would be expected to have a backwater influence extending to the culvert.

No historical flood data are available for this tributary. Magnitude and water surface elevations for the flood of record are not known. High water marks for large flood events were not evident. No Flood Insurance Studies were identified for the Chilkat River or its tributaries, including this one.

A site visit was conducted on October 7, 2005. A rapid assessment and cursory site survey were conducted for this phase as described in Section 3.2. The existing culvert is a 48-inch CMP with no stream substrate material in the bottom of the pipe. The bottom of the pipe is rusted. The pipe should be replaced for longevity. From the site survey, the existing pipe is approximately 66-ft long at approximately 0.0215-ft/ft slope. A small amount of flow was observed. No flooding problems with the existing culvert were reported in the anecdotal record or indicators observed in the field.

The creek is too small for navigation. This project will not impact navigation. The confluence with the Chilkat River is approximately 1,000-ft downstream. No upstream

¹ As stated in the MOA - **Tier 1 stream simulation** fish passage design attempts to replicate natural stream channel conditions within the culvert. Culvert width at the ordinary high water (OHW) stage is 90-percent or greater than the channel width at OHW. Slope varies by no more than 1-percent from adjacent stream reaches. Substrate is placed within the culvert and designed to remain dynamically stable for flows up to the 50-year event and contain a sufficient volume of fines to limit subsurface flow. Culvert inverts are buried to 40-percent of the diameter for circular culverts or 20-percent of the rise for arch pipes. (ADFG and ADOT&PF, 2001)

confluences were observed in the vicinity. Therefore, no impacts to confluences are expected. This stream runs through a portion of the Southeast Road builder gravel pit upstream of the highway.

Reach scale geomorphic conditions were summarized in the Stream and Habitat Inventory (S&HI) from observations and simple tape measurements by hand. On the reach scale, the upstream channel is a 3-6' wide, E type channel with a substrate of mixed sand and organics. There is a small pool at the culvert inlet. Downstream of the culvert the stream winds along the toe of the road fill slope back to station 234+50. The upstream half of this reach is also an E type channel 3-6' wide with a sandy/organic substrate. Stream banks are grassy, woody debris is present and alder often overhangs the stream. The lower half of this reach is influenced by the river backwater, wider (6-10'), more open and 6-18" deep. Substrate is silt, sand, fine gravels and organic matter. Aquatic weeds shape the stream meander and banks are grassy or vegetated with alder and willow.

The S&HI indicates that this stream is used by coho as spawning and rearing habitat. Dolly Varden use this stream for rearing. The stream is listed in the Anadromous Waters Catalog as catalog number: 115-32-10250-2004.

5.3 Hydrology

The contributing basin has a drainage area of approximately 0.47 square miles and extends up to near the summit of Mount Ripinski (3,679 feet). The watershed is steep, with an average watershed slope of 63 percent. There is no perennial channel depicted on the USGS 7.5 minute topographical map. The perennial flow present on the valley floor may be largely contributed by seeps at the toe of the hill slope. There is very little storage in the basin and there are no glaciers. The watershed is largely undeveloped, with slight industrial use in the lower portion of the basin.

There is no known gage information for this stream. Peak flow estimates using regional regression equations ranged from 42 cfs for the 2-year event to 130 cfs for the 100-year flood. The fish passage design flow, which is 40 percent of the 2-year event, is 17 cfs. There is no local input to report for this basin.

5.4 Hydraulic Design

At this phase, preliminary design was completed in support of the Preliminary Engineering Report. Final designs will require detailed stream cross section and profile survey. Final culvert designs will be prepared and documented for submittal with the Plans-in-Hand.

A 6'-9" by 4'-11" pipe arch is recommended as the replacement at this crossing. This size pipe will satisfy requirements of the Tier 1 stream simulation design method for fish passage as stated in the MOA. This culvert will provide sufficient span to accommodate the 6.7-ft wide reference stream channel width averaged from cross sections 53 feet upstream and 45 feet downstream of the existing pipe measured by the Inter-Fluve survey

(October, 2005) and representative of stream conditions locally at the culvert. The culvert would be set at a slope to match the existing stream system. Stream substrate will be placed in the bottom of the pipe to fill a minimum of 20 percent of the rise. Concepts are shown in Section 23.3.

Existing and proposed conditions were modeled with HEC-RAS. Results of modeling indicate that the proposed culvert will pass the 50-year flood with headwater elevation to culvert rise ratio equal to 1.02.

Table 5-1. 222+51 Hydrologic and Hydraulic Summary

Drainage Area = 0.47-square miles

Exceedance probability	10%	2%	1%
Return period	10-year (Q10)	50-year (Q50)	100-year (Q100)
Design discharge (cfs)	79	114	130
Flow depth at inlet (ft)	2.82	3.98	4.59
Hw/D	0.72	1.02	1.17

Note: Design was completed to preliminary level in support of the Preliminary Engineering Report based on cursory survey data collected by Inter-Fluve based on a relative horizontal and vertical datum. Final design will include site topographic survey.

5.5 23 CFR

There is no known FEMA Flood Insurance Study for the existing culvert. The proposed action includes a culvert larger in size and more hydraulically efficient than the existing culvert. Hydraulic analysis indicates that the upstream water surface elevations will be lower with the proposed culvert than currently exist. Risks of the proposed culvert are considered minimal. There is a reduction in upstream backwater effects and more efficient conveyance of flows through the pipe. There is less likelihood of debris blocking the culvert. The proposed culvert will improve stream process and provide more natural flood plain connectivity.

5.6 Conclusion

The hydraulic features of the proposed action are developed to a preliminary level at this phase in support of the Preliminary Engineering Report. Design will be completed for submittal with Plans-in-Hand. The proposed culvert is not expected to impact the flood plain or environment. The proposed culvert meets ADOT&PF’s requirements for conveyance of the 50-year event. The proposed culvert was designed for fish passage using the Tier 1 method to simulate adjacent stream conditions. This provides favorable continuity of stream processes and passage of fish through the culvert from adjacent stream reaches.

The hydrologic and hydraulic summary for the proposed culvert are presented in Table 5-1.

5.7 Riprap

The culvert was designed to provide fish passage using Tier 1 stream simulation to maintain continuity of flow of water and sediment. No riprap is proposed at this time.

5.8 Station 222+51 – Existing conditions photos

Existing Culvert: 48-inch cmp

Catalog Number: 115-32-10250-2004

Fish Use: Rearing coho and Dolly Varden. Spawning coho

Description: This location was referenced as Station 245+50 in the S&HI. Based on hand measurements, upstream of the culvert the stream is a 3-6' wide, E type channel with a substrate of mixed sand and organics. There is a small pool at the culvert inlet. Downstream of the culvert the stream winds along the toe of the road fill slope back to (S&HI) station 234+50. The upstream half of this reach is also an E type channel 3-6' wide with a sandy/organic substrate. Stream banks are grassy, woody debris is present and alder often overhangs the stream. The lower half of this reach is influenced by the river backwater, wider (6-10'), more open and 6-18" deep. Substrate is silt, sand, fine gravels and organic matter. Aquatic weeds shape the stream meander and banks are grassy or vegetated with alder and willow.



6. Culvert Replacement at Station 319+13

6.1 Introduction

The unnamed tributary crossing the highway at station 319+13 (S&HI Station 342+00) is comprised of an existing circular 36-inch corrugated metal pipe (CMP). The bottom of the pipe is rusted with the outlet unraveled. It is recommended that the pipe be replaced. At this Preliminary Engineering Report phase, the pipe was preliminarily designed based on Tier 1 stream simulation methods outlined in the MOA. Tier 1 methods were selected based on the high quality of upstream habitats. This project will replace the existing pipe with a larger 6'-9" by 4'-11" pipe arch to convey flood flows and provide fish passage.

6.2 Hydraulic History

This unnamed tributary crosses the Haines Highway at about elevation 26.5-ft. As described in Section 4.3.1, MHHW is at elevation 9.4-ft (NAVD 88) and based on approximate modeling tidal backwater will not extend to this location.

Field indicators of Chilkat River backwater (i.e. deposition of fine sediments) extend upstream along the tributary to the location of the existing culvert. Therefore, the culvert is impacted by frequently occurring Chilkat River backwater effects.

No historical flood data are available for this tributary. Magnitude and water surface elevations for the flood of record are not known. High water marks for large flood events were not evident. No Flood Insurance Studies were identified for the Chilkat River or its tributaries, including this one.

A site visit was conducted on October 7, 2005. A rapid assessment and cursory site survey were conducted for this phase as described in Section 3.2. The existing culvert is a 36-inch CMP with no sediment in the bottom of the pipe. The bottom of the pipe is rusted with a section of the outlet unraveled. The pipe should be replaced for longevity. From the site survey, the existing pipe is approximately 53-ft long at approximately 0.0137-ft/ft slope. The outlet is perched approximately 0.25- to 0.6-ft above the scour pool water surface. The pool is about 1.1-ft deep. A small amount of flow was observed.

The creek is too small for navigation. This project will not impact navigation. The confluence with the Chilkat River is approximately 290-ft downstream. No upstream confluences were observed in the vicinity. No impacts to confluences are expected. No mining occurs on this stream.

Reach scale geomorphic conditions were summarized in the Stream and Habitat Inventory (S&HI) based on observations and simple tape measurements by hand. Upstream of the culvert the complex channel of the stream meanders among alder roots and downfall. On the reach scale, the upstream channel is 1-3' wide with a substrate of gravel and organics. Depth is 6-8" and overhanging cover is dense. Periodically, hillside

processes deliver sediments to this site. No problems with conveyance through the existing culvert were reported in the anecdotal record or indicators observed in the field. The downstream end of the culvert is perched 3-4" and unraveled. The stream meanders along the road back to station 316+50 before entering the Chilkat River. The river backwaters the stream and deposits silt over the gravel bed. On the reach scale, the downstream channel is 4-6' wide and 3-4" deep. It lies in an old flood channel of the river. Stream banks are grass covered.

The S&HI indicates that this stream is used by coho and Dolly Varden as rearing habitat. The stream is not listed in the Anadromous Waters Catalog.

6.3 Hydrology

The contributing basin has a drainage area of approximately 0.6 square miles. The basin extends up to Seven Mile Saddle, which connects into the Shakasevi drainage on the east side of the divide. The high point of the basin is at 3,904 feet at the summit of an unnamed peak. The watershed has an average slope of 42 percent. The USGS 7.5 minute topographical map depicts a perennial stream channel that is believed to be within the contributing area for the culvert. The bulk of the perennial flow present on the valley floor may be largely contributed by seeps at the toe of the hill slope and possibly by hyporheic flow from the main stem Chilkat. There is virtually no storage in the basin and there are no glaciers. The watershed is undeveloped.

There is no known gage information for this stream. Peak flow estimates using regional regression equations ranged from 50 cfs for the 2-year event to 154 cfs for the 100-year flood. The fish passage design flow, which is 40 percent of the 2-year event, is 20 cfs. There is no local input to report for this basin.

6.4 Hydraulic Design

At this phase, preliminary design was completed in support of the Preliminary Engineering Report. Final designs will require detailed stream cross section and profile survey. Final culvert designs will be prepared and documented for submittal with the Plans-in-Hand.

A 6'-9" by 4'-11" pipe arch is recommended as the replacement at this crossing to satisfy requirements of the Tier 1 (stream simulation) design method for fish passage as stated in the MOA. This culvert will provide sufficient span to accommodate the 5.1-ft wide reference stream channel measured 17 feet upstream of the culvert by the Inter-Fluve survey (October, 2005) and representative of stream conditions locally at the culvert. November, 2008 survey measured 4 to 5 ft wide channel widths approximately 100 feet downstream of the culvert. The culvert would be set at a slope to match the existing stream system. Stream substrate will be placed in the bottom of the pipe to fill a minimum of 20-percent of the rise. Concepts are shown in Section 23.3.

Existing and proposed conditions were modeled with HEC-RAS. Results of modeling indicate that the proposed culvert will pass the 50-year flood with headwater elevation to culvert rise ratio equal to 1.16.

Table 6-1. 319+13 Hydrologic and Hydraulic Summary

Drainage Area = 0.60-square miles

Exceedance probability	10%	2%	1%
Return period	10-year (Q10)	50-year (Q50)	100-year (Q100)
Design discharge (cfs)	93	135	154
Flow depth at inlet (ft)	3.36	4.54	5.09
Hw/D	0.86	1.16	1.30

Note: Design was completed to preliminary level in support of the Preliminary Engineering Report based on cursory survey data collected by Inter-Fluve based on a relative horizontal and vertical datum. Final design will include site topographic survey.

6.5 23 CFR

There is no known FEMA Flood Insurance Study for the existing culvert. The proposed action includes a culvert larger in size and more hydraulically efficient than the existing culvert. Hydraulic analysis indicates that the upstream water surface elevations will be lower with the proposed culvert than currently exist. Risks of the proposed culvert are considered minimal. There is a reduction in upstream backwater effects and more efficient conveyance of flows through the pipe. There is less likelihood of debris blocking the culvert. The proposed culvert will improve stream process and provide more natural flood plain connectivity.

6.6 Conclusion

The hydraulic features of the proposed action are developed to a preliminary level at this phase in support of the Preliminary Engineering Report. Design will be completed for submittal with Plans-in-Hand. The proposed culvert is not expected to impact the flood plain or environment. The proposed culvert was designed for fish passage using the Tier 1 method to simulate adjacent stream conditions. This provides favorable continuity of stream processes and passage of fish through the culvert from adjacent stream reaches.

The hydrologic and hydraulic summary for the proposed culvert are presented in Table 6-1.

6.7 Riprap

The culvert was designed using Tier 1 stream simulation to maintain continuity of flow of water and sediment. No riprap is proposed at this time.

6.8 Station 319+13 – Existing conditions photos

Existing Culvert: 36-inch cmp

Fish Use: Rearing coho and Dolly Varden

Description: This location was referenced as Station 342+00 in the S&HI. Based on hand measurements, upstream of the culvert the complex channel of the stream meanders among alder roots and downfall. The stream is 1-3' wide with a substrate of gravel and organics. Depth is 6-8" and overhanging cover is dense. The downstream end of the culvert is perched 3-4" and unraveled. The stream meanders along the road back to station 316+50 before entering the Chilkat River. The river backwaters the stream and deposits silt over the gravel bed. The stream is 4-6' wide and 3-4" deep. It lies in an old flood channel of the river. Stream banks are grass covered.



7. Culvert Replacement at Station 324+79

7.1 Introduction

The unnamed tributary crossing the highway at station 324+79 (S&HI station 347+50) is comprised of an existing circular 48-inch corrugated metal pipe (CMP). The pipe bottom is rusted and the inlet is damaged; the pipe should be replaced. At this Preliminary Engineering Report phase, the pipe was conceptually designed based on Tier 1 stream simulation methods outlined in the MOA. Tier 1 methods were selected based on the high quality of upstream habitats. This project will replace the existing pipe with a larger 7'-3" by 5'-3" pipe arch to convey flood flows without overtopping the road and provide fish passage.

7.2 Hydraulic History

This unnamed tributary crosses the Haines Highway at about elevation 28-ft. As described in Section 4.3.1, MHHW is at elevation 9.4-ft (NAVD 88 and based on approximate modeling tidal backwater will not extend to this location.

Field indicators of Chilkat River backwater (i.e. deposition of fine sediments) extend upstream along the tributary to the location of the existing culvert. Therefore, the culvert is impacted by frequently occurring Chilkat River backwater effects.

No historical flood data are available for this tributary. Water surface elevations for flood of record are not known. High water marks for large flood events were not evident. No Flood Insurance Studies were identified for the Chilkat River or its tributaries, including this one.

A site visit was conducted on October 7, 2005. A rapid assessment and cursory site survey were conducted for this phase as described in Section 3.2. The existing culvert is a 48-inch CMP with no stream substrate material observed in the bottom of the pipe. The pipe bottom is rusted and the inlet is damaged. The pipe should be replaced for longevity. From the site survey, the existing pipe is approximately 60-ft long laid at approximately 0.0194-ft/ft slope. The rim of the downstream scour pool is 1.2-ft higher than the culvert outlet invert and 0.03-ft lower than the culvert inlet effectively backwatering most of the pipe length. No flow was observed. No flooding problems with the existing culvert were reported in the anecdotal record or indicators observed in the field.

The creek is too small for navigation. This project will not impact navigation. The confluence with the Chilkat River is approximately 350-ft downstream. No upstream confluences were observed in the vicinity. No impacts to confluences are expected. No mining occurs on this stream.

Reach scale geomorphic conditions were summarized in the Stream and Habitat Inventory (S&HI) from observations and simple tape measurements by hand. The culvert appears to be fairly recently replaced yet the bottom of the pipe is rusted. , On the reach

scale, the upstream channel is a 1-2' wide E type channel with a fine silt and gravel substrate. The stream drains a swamp fed by numerous springs along the toe of the mountain. The culvert outlet empties into a short section of gravel bottomed stream with a width of 2-3' and grassy banks. The stream then turns into a 3-6' wide backwatered slough with a silt substrate. Springs feed this section of the stream.

The S&HI indicates that this stream is used by coho and Dolly Varden as rearing habitat. The stream is listed in the Anadromous Waters Catalog as catalog number: 115-32-10250-2014.

7.3 Hydrology

The contributing basin has a drainage area of approximately 1.23 square miles. The basin extends up to Seven Mile Saddle, which connects into the Shakasevi drainage on the east side of the divide. The high point of the basin is at 4,088 feet on the ridge leading north to Tukgahgo Mountain. The watershed has an average slope of 55 percent. The USGS 7.5 minute topographical map depicts two perennial stream channels that have their confluence 150 meters upstream of the culvert. Some of the perennial flow present on the valley floor may possibly be from hyporheic flow from the main stem Chilkat. There is virtually no storage in the basin and no glaciers. A pack trail heading to Seven mile Saddle follows the eastern edge of the basin; otherwise, the watershed is undeveloped.

There is no known gage information for this stream. Peak flow estimates using regional regression equations ranged from 92 cfs for the 2-year event to 280 cfs for the 100-year flood. The fish passage design flow, which is 40 percent of the 2-year event, is 37 cfs. Hydraulic analysis for the existing pipe indicates that the 2-year event will over top the road. Given that the anecdotal record of culverts along the Haines Highway has not identified this culvert to be a problem, the flows from the hydrology estimates are suspected to be too large and in error. This is the only tributary with estimated flows being suspiciously high. Therefore, an alternate approach was taken where the hydraulic capacity of the existing culvert was used to back calculate the flow that meets design criteria ($HW/D < 1.5$). In addition, the culvert configuration required to provide fish passage was analyzed to confirm that the flood conveyance was equal to or greater than existing conditions.

For existing conditions the flow corresponding to a $HW/D \sim 1.5$ is approximately 169-cfs (10-year event predicted flow). Prorating the predicted flows to the ADOT&PF criteria of $HW/D < 1.5$ for the 50-year design event would approximate the Q2-yr ~ 63 -cfs, Q10-yr ~ 116 -cfs, Q50-yr ~ 169 -cfs and Q100-yr ~ 192 -cfs. These flows are approximately 70-percent of the estimates using regional regression equations. As noted in Section 3, precipitation values recorded in Haines are 80-percent of regional regression values providing a possible explanation for this reduction in flows. The corresponding fish passage flow is roughly 25-cfs. Based on this hydrology and hydraulic analysis, a 7'-3"x5'-3" pipe arch would be required to prevent overtopping of the road. This is a significantly larger pipe than the existing structure which has not been reported in the

anecdotal record to be a problem. The hydrology remains suspect and will be further scrutinized during final design.

There is no local input to report for this basin.

7.4 Hydraulic Design

At this phase, preliminary design was completed in support of the Preliminary Engineering Report. Final designs will require detailed stream cross section and profile survey. Final culvert designs will be prepared and documented for submittal with the Plans-in-Hand.

A 7'-3" by 5'-3" pipe arch is recommended as the replacement at this crossing to provide sufficient flood conveyance for the estimated stream flows and prevent overtopping of the road by the estimated 50-year flow. This size pipe will satisfy requirements of the Tier 1 stream simulation design method for fish passage as stated in the MOA. This culvert will provide sufficient span to accommodate the average 6.9-ft wide reference stream channel width measured 20 feet upstream and 42 feet downstream of the culvert by the Inter-Fluve survey (October, 2005) and representative of stream conditions locally at the culvert. The culvert would be set at a slope to match the existing stream system. Stream substrate will be placed in the bottom of the pipe to fill a minimum of 20-percent of the rise. Concepts are shown in Section 23.3.

Existing and proposed conditions were modeled with HEC-RAS. Results of modeling indicate that the proposed culvert will provide greater conveyance capacity than currently exists. Results of modeling indicate that the proposed culvert will pass the 50-year flood with headwater elevation to culvert rise ratio equal to 1.08.

Table 7-1. 324+79 Hydrologic and Hydraulic Summary

Drainage Area = 1.23-square miles

Exceedance probability	10%	2%	1%
Return period	10-year (Q10)	50-year (Q50)	100-year (Q100)
Design discharge (cfs)	116	169	192
Flow depth at inlet (ft)	3.34	4.22	5.09
Hw/D	0.85	1.08	1.30

Notes:

1. Design was completed to preliminary level in support of the Preliminary Engineering Report based on cursory survey data collected by Inter-Fluve based on a relative horizontal and vertical datum. Final design will include site topographic survey.
2. Through the hydraulic analysis a 7.25'x5.25' pipe arch is required to prevent the estimated 50-year flood from overtopping the road. This is a significantly larger pipe than the existing structure which has not been reported in the anecdotal record to be a problem. The hydrology remains suspect and will be further scrutinized during final design.

7.5 23 CFR

There is no known FEMA Flood Insurance Study for the existing culvert. The proposed action includes a culvert larger in size and more hydraulically efficient than the existing culvert. Hydraulic analysis indicates that the upstream water surface elevations will be lower with the proposed culvert than currently exist. Risks of the proposed culvert are considered minimal. There is a reduction in upstream backwater effects and more efficient conveyance of flows through the pipe. There is less likelihood of debris blocking the culvert. The proposed culvert will improve stream process and provide more natural flood plain connectivity.

7.6 Conclusion

The hydraulic features of the proposed action are developed to a preliminary level at this phase in support of the Preliminary Engineering Report. Design will be completed for submittal with Plans-in-Hand. The proposed culvert is not expected to impact the flood plain or environment. The proposed culvert meets ADOT&PF's requirements for conveyance of the 50-year event. The proposed culvert was designed for fish passage using the Tier 1 method to simulate adjacent stream conditions. This provides favorable continuity of stream processes and passage of fish through the culvert from adjacent stream reaches.

The hydrologic and hydraulic summary for the proposed culvert are presented in Table 7-1.

7.7 Riprap

The culvert was designed using Tier 1 stream simulation to maintain continuity of flow of water and sediment. No riprap is proposed at this time.

7.8 Station 324+79 – Existing conditions photos

Existing Culvert: 48-inch cmp

Catalog Number: 115-32-10250-2014

Fish Use: Rearing coho and Dolly Varden

Description: This location was referenced as Station 347+50 in the S&HI. The culvert appears to be fairly recently replaced. Based on hand measurements, upstream of the culvert the stream is a 1-2' wide E type channel with a fine silt and gravel substrate. The stream drains a swamp fed by numerous springs along the toe of the mountain. The culvert outlet empties into a short section of gravel bottomed stream with a width of 2-3' and grassy banks. The stream then turns into a 3-6' wide backwatered slough with a silt substrate. Springs feed this section of the stream.



8. Culvert Replacement at Station 483+18

8.1 Introduction

The unnamed tributary crossing the highway at station 483+18 (S&HI station 506+25) is comprised of an existing circular 48-inch corrugated metal pipe (CMP) with a rusted bottom and outlet apron. It is recommended that the pipe be replaced. At this Preliminary Engineering Report phase, the pipe was preliminarily designed based on Tier 1 stream simulation methods outlined in the MOA. Tier 1 methods were selected based on the high quality of upstream habitats. This project will replace the existing pipe with a larger 7'-3" by 5'-3" pipe arch to convey flood flows and provide fish passage.

8.2 Hydraulic History

This unnamed tributary crosses the Haines Highway at about elevation 35-ft. As described in Section 4.3.1, MHHW is at elevation 9.4-ft (NAVD 88) and based on approximate modeling tidal backwater will not extend to this location.

Field indicators of Chilkat River backwater (i.e. deposition of fine sediments) extend upstream along the tributary to the location of the existing culvert. Therefore, the culvert is impacted by frequently occurring Chilkat River backwater effects.

No historical flood data are available for this tributary. Water surface elevations for the flood of record are not known. High water marks for large flood events were not evident. No Flood Insurance Studies were identified for the Chilkat River or its tributaries, including this one.

A site visit was conducted on October 7, 2005. A rapid assessment and cursory site survey were conducted for this phase as described in Section 3.2. The existing culvert is a 48-inch CMP with no stream substrate material observed in the bottom of the pipe. The bottom of the pipe and outlet apron is rusted. The pipe should be replaced for longevity. From the site survey, the existing pipe is approximately 65-ft long laid at approximately 0.0091-ft/ft slope. The outlet of the downstream scour pool is 0.13-ft lower than the culvert outlet invert. Low flows appear able to backwater the culvert outlet invert. No flooding problems with the existing culvert were reported in the anecdotal record or indicators observed in the field.

The creek is too small for navigation. This project will not impact navigation. The confluence with the Chilkat River is approximately 125-ft downstream. No upstream confluences were observed in the vicinity. No impacts to confluences are expected. No mining occurs on this stream.

Reach scale geomorphic conditions were summarized in the Stream and Habitat Inventory (S&HI) from observations and simple tape measurements by hand. On the reach scale, the upstream channel is about 8' wide and flows over a silt/organic substrate. The stream is backwatered by the Chilkat River and had a depth of 6-8" at the time of the

survey. Banks are muddy and grassy, with willow and alder growing close to the water on one side. The culvert empties into a 30' diameter pool with a depth of 3'. Banks are silty up to the level of frequent river backwater and then formed of grass and young willow/alder. Substrate is silt. Downstream of the pool the channel is 10' wide but terminates abruptly at a sandbar about 125' from the road. A small trickle flows over the sandbar and into an isolated pool. Fish access is dependent on the river water level.

The S&HI indicates that this stream is used by coho and Dolly Varden as rearing habitat. The stream is listed in the Anadromous Waters Catalog as catalog number: 115-32-10250-2024.

8.3 Hydrology

The contributing basin has a drainage area of approximately 1.07 square miles. The basin extends up to a ridge leading northeast toward Tukgahgo Mountain. The high point of the basin is at 4,490 feet. The watershed has an average slope of 57 percent. The USGS 7.5 minute topographical map depicts a single perennial stream channel with its headwaters at a small lake. A portion of the perennial flow present on the valley floor may be contributed by seeps at the toe of the hill slope and possibly by hyporheic flow from the main stem Chilkat. There is very little storage in the basin and there are no glaciers. The watershed is undeveloped.

There is no known gage information for this stream. Peak flow estimates using regional regression equations ranged from 76 cfs for the 2-year event to 232 cfs for the 100-year flood. The fish passage design flow, which is 40 percent of the 2-year event, is 30 cfs. There is no local input to report for this basin.

8.4 Hydraulic Design

At this phase, preliminary design was completed in support of the Preliminary Engineering Report. Final designs will require detailed stream cross section and profile survey. Final culvert designs will be prepared and documented for submittal with the Plans-in-Hand.

By Tier 1 methods, a 7'-4" by 5'-4" pipe arch would be required to accommodate stream width at this crossing. This size pipe will satisfy requirements of the Tier 1 stream simulation design method for fish passage as stated in the MOA. This culvert will provide sufficient span to accommodate the 8-ft wide reference stream channel width measured 104 feet upstream of the existing culvert by the Inter-Fluve survey (October, 2005) and representative of stream conditions locally at the culvert. The culvert would be set at a slope to match the existing stream system. Stream substrate will be placed in the bottom of the pipe arch to fill a minimum of 20-percent of the rise. Concepts are shown in Section 23.3.

Existing and proposed conditions were modeled with HEC-RAS. Results of modeling indicate that the proposed culvert will provide greater conveyance capacity than currently

exists. The proposed culvert will pass the 50-year flood with headwater elevation to culvert rise ratio equal to 1.29.

Table 8-1. 483+18 Hydrologic and Hydraulic Summary

Drainage Area = 1.07-square miles

Exceedance probability	10%	2%	1%
Return period	10-year (Q10)	50-year (Q50)	100-year (Q100)
Design discharge (cfs)	139	203	232
Flow depth at inlet (ft)	3.92	5.49	6.41
Hw/D	0.92	1.29	1.51

Note: Design was completed to preliminary level in support of the Preliminary Engineering Report based on cursory survey data collected by Inter-Fluve based on a relative horizontal and vertical datum. Final design will include site topographic survey.

8.5 23 CFR

There is no known FEMA Flood Insurance Study for the existing culvert. The proposed action includes a culvert larger in size and more hydraulically efficient than the existing culvert. Hydraulic analysis indicates that the upstream water surface elevations will be lower with the proposed culvert than currently exist. Risks of the proposed culvert are considered minimal. There is a reduction in upstream backwater effects and more efficient conveyance of flows through the pipe. There is less likelihood of debris blocking the culvert. The proposed culvert will improve stream process and provide more natural flood plain connectivity.

8.6 Conclusion

The hydraulic features of the proposed action are developed to a preliminary level at this phase in support of the Preliminary Engineering Report. Design will be completed for submittal with Plans-in-Hand. The proposed culvert is not expected to impact the flood plain or environment.

The hydrologic and hydraulic summary for the proposed culvert are presented in Table 8-1.

8.7 Riprap

The culvert was designed using Tier 1 stream simulation to maintain continuity of flow of water and sediment. No riprap is proposed at this time.

8.8 Station 483+18– Existing conditions photos

Existing Culvert: 48-inch cmp

Catalog Number: 115-32-10250-2024

Fish Use: Rearing coho and Dolly Varden

Description: This location was referenced as Station 506+25 in the S&HI. Based on hand measurements, upstream of the culvert the stream is about 8' wide and flows over a silt/organic substrate. The stream is backwatered by the Chilkat River and had a depth of 6-8" at the time of the survey. Banks are muddy and grassy, with willow and alder growing close to the water on one side. The culvert empties into a 30' diameter pool with a depth of 3'. Banks are silty up to the level of frequent river backwater and then formed of grass and young willow/alder. Substrate is silt. Downstream of the pool the channel is 10' wide but terminates abruptly at a sandbar about 125' from the road. A small trickle flows over the sandbar and into an isolated pool. Fish access is dependent on the river water level.



9. Culvert Replacement at Station 512+24

9.1 Introduction

This tributary is referred to locally as 10-Mile Creek. The tributary crosses the highway at station 512+24 (S&HI station 535+50) near a hydroelectric plant. The existing crossing is comprised of one 24-inch and one 36-inch circular corrugated metal pipes (CMP). At this Preliminary Engineering Report phase, the replacement pipe was preliminarily designed to meet Tier 1 stream simulation fish passage design methods outlined in the MOA. Tier 1 methods were selected based on the high quality of upstream habitats. This project will replace the existing pipes with one larger 14'-1" by 6'-2" aluminum box culvert to convey flood flows, provide fish passage and meet site cover restrictions.

9.2 Hydraulic History

10-Mile Creek crosses the Haines Highway at about elevation 37-ft. As described in Section 4.3.1, MHHW is at elevation 9.4-ft (NAVD 88) and based on approximate modeling tidal backwater will not extend to this location.

10-Mile Creek discharges into 10-Mile Slough, then enters the main stem of the Chilkat River approximately 800-ft downstream of the culverts. Field indicators of Chilkat River backwater (i.e. deposition of fine sediments) extend upstream along 10-Mile Slough to the confluence with 10-Mile Creek. The culverts appear to be above the Chilkat River backwater. Therefore, it appears that the new culvert will not be impacted by frequently occurring Chilkat River backwater effects.

No historical flood data are available for this tributary. Magnitude and water surface elevations for the flood of record are not known. High water marks for large flood events were not evident. No Flood Insurance Studies were identified for the Chilkat River or its tributaries, including this one.

A site visit was conducted on October 7, 2005. A rapid assessment and cursory site survey were conducted for this phase as described in Section 3.2. The existing culverts are one 24-inch and one-36-inch diameter circular CMP. The majority of the flows pass through the 36-inch pipe. Approximately 0.6-ft of material was measured in the bottom of the 36-inch pipe. No perching of the pipe or formation of a scour pool was observed. From survey measurements on the 36-inch CMP, the length is approximately 73-ft long at approximately 0.0087-ft/ft slope. No flooding problems with the existing culvert were reported in the anecdotal record or indicators observed in the field.

The creek is too small for navigation. This project will not impact navigation. The confluence with the Chilkat River is approximately 800-ft downstream of the culverts. The confluence with 10-Mile Slough is approximately 100-ft downstream. No upstream confluences were observed in the vicinity. No impacts to confluences are expected. No mining occurs on this stream.

Reach scale, geomorphic conditions were summarized in the Stream and Habitat Inventory (S&HI) from observations and simple tape measurements by hand. On the reach scale, the upstream channel is about 15' wide and flows in riffles over ideal spawning gravels. The banks are well vegetated and overhang the stream. A run of the river hydroelectric plant is upstream. Downstream of the culverts, the stream varies in width from 15-20', the bottom is gravel and the stream is heavily utilized by spawning salmon. Stream banks are fully vegetated with grasses. Further downstream the stream meanders through a wide, old river channel that is frequently backwatered by the river.

The S&HI indicates that this stream is used by coho and Dolly Varden as rearing habitat. Pink and chum use this stream for spawning habitat. The stream is listed in the Anadromous Waters Catalog as catalog number: 115-32-10250-2028-3002.

9.3 Hydrology

10-Mile Creek has a drainage area of approximately 1.46 square miles. The high point of the basin is at 4,441 feet at the summit of Tukgahgo Mountain. The watershed has an average slope of 44 percent. The USGS 7.5 minute topographical map depicts a perennial stream channel that is fed by several lakes in the upper basin. This storage comprises just under 2 percent of the basin area. Glaciers on the north side of Tukgahgo Mountain lie within the basin but comprise less than 5 percent of the basin area. The basin is narrow at the outlet, with little more than 500 hundred feet of stream channel between the culvert and the toe of the hill slope. A small hydroelectric operation is located on the stream at the hill slope toe and a small staging area is located on the north side of the stream upstream of the culvert. The hydropower plant is a run-of-the-river facility and does not impact the flow hydrograph (J. Floreski, personal communication to M. Sogge, March 2006). The remainder of the watershed is undeveloped.

There is no known gage information for this stream. Peak flow estimates using regional regression equations ranged from 73 cfs for the 2-year event to 220 cfs for the 100-year flood. The fish passage design flow, which is 40 percent of the 2-year event, is 29 cfs. There is no local input to report for this basin.

9.4 Hydraulic Design

At this phase, preliminary design was completed in support of the Preliminary Engineering Report. Final designs will require detailed stream cross section and profile survey. Final culvert designs will be prepared and documented for submittal with the Plans-in-Hand.

By Tier 1 methods, a 14'-1" by 6'-2" aluminum box culvert would be required to accommodate stream width at this crossing and to meet site cover restrictions. This size pipe will satisfy requirements of the Tier 1 stream simulation design method for fish passage as stated in the MOA. This culvert will provide sufficient span to accommodate the 15.3-ft wide reference stream channel width measured 30 feet upstream of the culvert by the Inter-Fluve survey (October, 2005) and representative of stream conditions locally

at the culvert. The culvert would be set at a slope to match the existing stream system. Stream substrate will be placed in the bottom of the pipe to fill a minimum of 20-percent of the rise. Concepts are shown in Section 23.3.

Existing and proposed conditions were modeled with HEC-RAS. Results of modeling indicate that the proposed culvert will pass the 50-year flood with headwater elevation to culvert rise ratio equal to 0.79.

Table 9-1. 512+24 Hydrologic and Hydraulic Summary

Drainage Area = 1.46-square miles

Exceedance probability	10%	2%	1%
Return period	10-year (Q10)	50-year (Q50)	100-year (Q100)
Design discharge (cfs)	130	193	220
Flow depth at inlet (ft)	2.78	3.51	3.77
Hw/D	0.63	0.79	0.85

Note: Design was completed to preliminary level in support of the Preliminary Engineering Report based on cursory survey data collected by Inter-Fluve based on a relative horizontal and vertical datum. Final design will include site topographic survey.

9.5 23 CFR

There is no known FEMA Flood Insurance Study for the existing culvert. The proposed action includes a culvert larger in size and more hydraulically efficient than the existing culvert. Hydraulic analysis indicates that the upstream water surface elevations will be lower with the proposed culvert than currently exist. Risks of the proposed culvert are considered minimal. There is a reduction in upstream backwater effects and more efficient conveyance of flows through the pipe. There is less likelihood of debris blocking the culvert. The proposed culvert will improve stream process and provide more natural flood plain connectivity.

9.6 Conclusion

The hydraulic features of the proposed action are developed to a preliminary level at this phase in support of the Preliminary Engineering Report. Design will be completed for submittal with Plans-in-Hand. The proposed culvert is not expected to impact the flood plain or environment. The proposed culvert meets ADOT&PF’s requirements for conveyance of the 50-year event. The proposed culvert was designed for fish passage using the Tier 1 method to simulate adjacent stream conditions. This provides favorable continuity of stream processes and passage of fish through the culvert from adjacent stream reaches.

The hydrologic and hydraulic summary for the proposed culvert are presented in Table 9-1.

9.7 Riprap

The culvert was designed using Tier 1 stream simulation to maintain continuity of flow of water and sediment. No riprap is proposed at this time.

9.8 Station 512+24 – Existing conditions photos

Existing Culverts: 30-inch cmp, 24-inch cmp

Catalog Number: 115-32-10250-2028-3002

Fish Use: Rearing coho and Dolly Varden. Spawning pink and chum

Description: This location was referenced as Station 535+50 in the S&HI. Based on hand measurements, upstream of the culverts the stream is about 15' wide and flows in riffles over ideal spawning gravels. The banks are well vegetated and overhang the stream. A hydroelectric plant is upstream. Downstream of the culverts the stream varies in width from 15-20', the bottom is gravel and the stream is heavily utilized by spawning salmon. Stream banks are fully vegetated with grasses. Further downstream the stream meanders through a wide, old river channel that is frequently backwatered by the river.



10. Culvert Replacement at Station 589+12

10.1 Introduction

The unnamed tributary crossing the highway at station 589+12 (S&HI station 612+40) is comprised of two existing circular 24-inch corrugated metal pipes (CMP). The bottoms of the pipes are rusted and the pipes should be replaced. At this Preliminary Engineering Report phase, the replacement pipe was preliminarily designed based on Tier 1 stream simulation methods outlined in the MOA. Tier 1 methods were selected based on the high quality of upstream habitats. This project will replace the existing pipes with a larger 7'-3" by 5'-3" pipe arch to convey flood flows and provide fish passage.

10.2 Hydraulic History

This unnamed tributary crosses the Haines Highway at about elevation 44-ft. As described in Section 4.3.1, MHHW is at elevation 9.4-ft (NAVD 88) and based on approximate modeling tidal backwater will not extend to this location.

This tributary discharges into a major side channel of the Chilkat River approximately 45 feet downstream of the culvert. Field indicators of Chilkat River backwater (i.e. deposition of fine sediments) extend upstream along the tributary to the location of the existing culvert. The culvert is impacted by frequently occurring Chilkat River backwater effects.

No historical flood data are available for this tributary. Magnitude and water surface elevations for the flood of record are not known. High water marks for large flood events were not evident. No Flood Insurance Studies were identified for the Chilkat River or its tributaries, including this one.

A site visit was conducted on October 7, 2005. A rapid assessment and cursory site survey were conducted for this phase as described in Section 3.2. The existing culverts are two 24-inch CMPs with no stream substrate material observed in the bottom of the pipes. The bottoms of the pipes are rusted and the pipes should be replaced for longevity. From the site survey, the two pipes are approximately 63-ft long at an average slope of 0.006-ft/ft. The pipes are higher than the adjacent streambed. No flow was observed. No flooding problems with the existing culvert were reported in the anecdotal record or indicators observed in the field.

The creek is too small for navigation. This project will not impact navigation. The confluence with a side channel of the Chilkat River is 45 feet downstream. No upstream confluences were observed in the vicinity. Therefore, no impacts to confluences are expected. No mining occurs on this stream.

Reach scale geomorphic conditions were summarized in the Stream and Habitat Inventory (S&HI) based on observations and simple tape measurements by hand. On the reach scale the upstream channel averages 2' wide E type channel with a very low

gradient. It is infrequently backwatered by the Chilkat River. The banks are thickly vegetated with grasses and the substrate is a blend of organics and silt. The stream leads into a broad wetland. Downstream of the culvert the stream banks are bare sand and the stream is heavily backwatered by the river. The substrate is silt/gravel and there is no cover.

The S&HI indicates that this stream is used by coho, Dolly Varden and cutthroat as rearing habitat. The stream is listed as catalog number: 115-32-10250-2032.

10.3 Hydrology

The contributing basin has a drainage area of approximately 0.65 square miles. The basin extends up to 4,035 feet. The watershed has an average slope of 49 percent. The USGS 7.5 minute topographical map does not depict a perennial stream channel. The perennial flow present on the valley floor is likely contributed by seeps at the toe of the hillslope as well as by hyporheic flow from a side channel of the mainstem Chilkat. There is virtually no storage in the basin and there are no glaciers. The watershed is undeveloped.

There is no known gage information for this stream. Peak flow estimates using regional regression equations ranged from 52 cfs for the 2-year event to 160 cfs for the 100-year flood. The fish passage design flow, which is 40 percent of the 2-year event, is 21 cfs. There is no local input to report for this basin.

10.4 Hydraulic Design

At this phase, preliminary design was completed in support of the Preliminary Engineering Report. Final designs will require detailed stream cross section and profile survey. Final culvert designs will be prepared and documented for submittal with the Plans-in-Hand.

A 6'-9 by 4'-11" pipe arch is recommended as the replacement at this crossing. This size pipe will satisfy requirements of the Tier 1 stream simulation design method for fish passage as stated in the MOA. This culvert will provide sufficient span to accommodate the 5.9-ft wide reference stream channel width measured 35 feet upstream of the culvert by the Inter-Fluve survey (October, 2005) and representative of stream conditions locally at the culvert. The culvert would be set at a slope to match the existing stream system. Stream substrate will be placed in the bottom of the pipe to fill a minimum of 20-percent of the rise. Concepts are shown in Section 23.3.

Existing and proposed conditions were modeled with HEC-RAS. Results of modeling indicate that the proposed culvert will pass the 50-year flood with headwater elevation to culvert rise ratio equal to 1.05.

Table 10-1. 589+12 Hydrologic and Hydraulic Summary

Drainage Area = 0.65-square miles

Exceedance probability	10%	2%	1%
Return period	10-year (Q10)	50-year (Q50)	100-year (Q100)
Design discharge (cfs)	96	140	160
Flow depth at inlet (ft)	3.36	4.40	4.92
Hw/D	0.80	1.05	1.17

Note: Design was completed to preliminary level in support of the Preliminary Engineering Report based on cursory survey data collected by Inter-Fluve based on a relative horizontal and vertical datum. Final design will include site topographic survey.

10.5 23 CFR

There is no known FEMA Flood Insurance Study for the existing culvert. The proposed action includes a culvert larger in size and more hydraulically efficient than the existing culvert. Hydraulic analysis indicates that the upstream water surface elevations will be lower with the proposed culvert than currently exist. Risks of the proposed culvert are considered minimal. There is a reduction in upstream backwater effects and more efficient conveyance of flows through the pipe. There is less likelihood of debris blocking the culvert. The proposed culvert will improve stream process and provide more natural flood plain connectivity.

10.6 Conclusion

The hydraulic features of the proposed action are developed to a preliminary level at this phase in support of the Preliminary Engineering Report. Design will be completed for submittal with Plans-in-Hand. The proposed culvert is not expected to impact the flood plain or environment. The proposed culvert was designed for fish passage using the Tier 1 method to simulate adjacent stream conditions. This provides favorable continuity of stream processes and passage of fish through the culvert from adjacent stream reaches.

The hydrologic and hydraulic summary for the proposed culvert are presented in Table 10-1.

10.7 Riprap

The culvert was designed using Tier 1 stream simulation to maintain continuity of flow of water and sediment. No riprap is proposed at this time.

10.8 Station 580+12 – Existing conditions photos

Existing Culverts: 2 - 24-inch cmps

Catalog Number: 115-32-10250-2032

Fish Use: Rearing coho, Dolly Varden and cutthroat

Description: This location was referenced as Station 612+40 in the S&HI. Based on hand measurements, upstream of the culverts the stream is a 2' wide E type channel with a very low gradient. It is infrequently backwatered by the Chilkat River. The banks are thickly vegetated with grasses and the substrate is a blend of organics and silt. The stream leads into a broad swamp. Downstream of the culvert the stream banks are bare sand and the stream is heavily backwatered by the river. The substrate is silt/gravel and there is no cover.

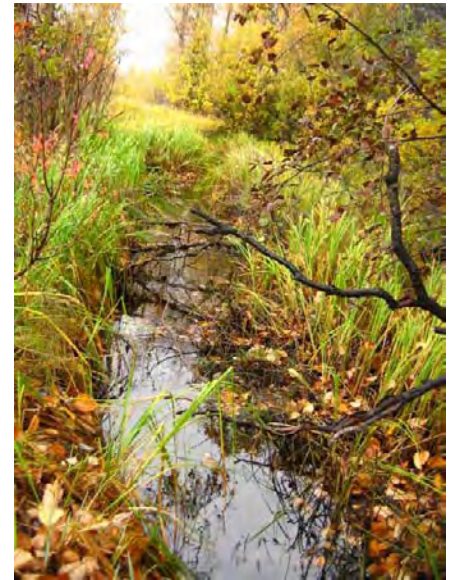

11. Culvert Replacement at Station 647+20

11.1 Introduction

This tributary is referred to locally as 13-Mile Creek. The tributary crossing of the highway at station 647+20 (S&HI station 670+00) is comprised of two existing circular 36-inch corrugated metal pipes (CMP). The bottoms of the pipes are stained. To provide fish passage and accommodate potential flows and debris loads these pipes should be replaced with a larger pipe arch. At this Preliminary Engineering Report phase, the replacement pipe was preliminarily designed based on Tier 1 stream simulation methods outlined in the MOA. Tier 1 methods were selected based on the good quality of upstream habitats. This project will replace the existing pipe with a larger 8'-10" by 6'-1" pipe arch to convey potential flood flows and provide fish passage.

The proposed highway alignment closely follows the existing alignment. Though this culvert is located on a debris flow fan, the volume of sediment observed to have deposited at the road following a flood in November 2005 is anticipated to either pass through a culvert inline with the approach stream alignment or can be managed by periodic maintenance operations. The larger impact of debris flow events at this site appears to be the dynamic history of the stream changing course and the point where the stream meets the road. The replacement culvert is sized to pass anticipated flood flows and provide fish passage.

11.2 Hydraulic History

This unnamed tributary currently crosses the Haines Highway at about elevation 48-ft. As described in Section 4.3.1, MHHW is at elevation 9.4-ft (NAVD) 88 and based on approximate modeling, tidal backwater will not extend to this location.

This tributary discharges into a major side channel of the Chilkat River approximately 700 feet downstream of the culvert. Field indicators of Chilkat River backwater (deposition of fine sediments) extend upstream along the tributary to the location of the existing culvert. The culvert appears to be impacted by frequently occurring Chilkat River backwater effects.

No historical flood data are available for this tributary. Water surface elevations for flood of record are not known. High water marks for large flood events were not evident. No Flood Insurance Studies were identified for the Chilkat River or its tributaries, including this one.

A site visit was conducted on October 7, 2005. A rapid assessment and cursory site survey of the existing culverts were conducted for this phase as described in Section 3.2. Detailed survey of the tributary between the culverts and Chilkat River side channel was conducted in November 2008. The existing culverts are two 36-inch CMP with no material in the bottom of the pipes. Measurements on one pipe, as a typical condition, indicates a length of approximately 59-ft long at approximately 0.016-ft/ft slope. Flow

was observed along the creek. No flooding problems with the existing culverts were reported in the anecdotal record or indicators observed in the field.

Following the November 2005 flood, the stream occupied a new channel uphill of the road. The stream currently encounters the road at Station 652+70 and splits, with the majority of flows going towards Haines to the 647+20 culvert, the remainder of flows go north and pass the highway through a 24-inch CMP at station 655+35. Flood conveyance of 13-Mile Creek past the highway can be improved by adding a culvert at station 652+70, routing the stream along the downhill side of the road and returning to the existing stream approximately 30 feet downstream of the existing culvert. This new culvert will be designed in conjunction with a mitigation concept at a later phase. The existing culvert at 647+20 will be replaced to pass overland flows and accommodate the full tributary flows should debris flows move the stream back into its alignment prior to the November 2005 flood.

The creek is too small for navigation. This project will not impact navigation. The confluence with the side channel of the Chilkat River is approximately 700 feet downstream. No upstream confluences were observed in the vicinity. Therefore, no impacts to confluences are expected. No mining occurs on this stream.

Reach scale geomorphic conditions were summarized in the Stream and Habitat Inventory (S&HI). Upstream of the culverts the stream splits almost immediately. The majority of flows follow a branch which runs in a roadside ditch up to near station 652+70 where it turns up the hill from the road. The section along the road is an E type channel 2' wide and +1' deep. The banks are vegetated with grasses that frequently overhang the full width of the stream. Substrate is gravel. The major branch of the stream is gravel bottomed and meanders away from the road in a stable bed where the stream broadens and winds through established forest with well forested banks. Downstream, the culverts empty into a broad 15' by 20' pool that leads into a reach scale average 4-8' wide E-channel backwatered at times by a beaver dam and the influence of a side channel of the river. The stream empties into the river near station 641+00. The stream banks are predominantly grass, with some willow. At times, the stream flows directly along the toe of the road fill. The lower section of the stream is much less well vegetated than the upper portion.

The S&HI indicates that this stream is used by coho and Dolly Varden as rearing habitat. This stream is used by pink salmon as spawning habitat. The stream is listed as catalog number: 115-32-10250-2040.

11.3 Hydrology

This stream has a drainage area of approximately 1.75 square miles. The high point of the basin is at 5,265 feet at the summit of an unnamed peak. The watershed has an average slope of 53 percent. The USGS 7.5 minute topographical map depicts a perennial stream channel with several branches midway up the basin. The southern branch is fed by lakes in the upper basin. This storage comprises less than 1 percent of the basin area. A small

glacier is depicted on the southeast side of the basin (map data is circa 1991) but the current status of this glacier is unknown. The basin is narrow at the outlet, with only a couple of hundred feet of stream channel between the culvert and the toe of the hill slope. The watershed is undeveloped.

There is no known gage information for this stream. Peak flow estimates using regional regression equations ranged from 96 cfs for the 2-year event to 291 cfs for the 100-year flood. The fish passage design flow, which is 40 percent of the 2-year event, is 38 cfs. There is no local input to report for this basin.

11.4 Hydraulic Design

This stream occasionally experiences debris flows which shift the location of the stream. The flood of November 2005 caused a shift of alignment with the stream currently encountering the road near station 652+70. A new culvert is proposed for Station 652+70 in conjunction with proposed mitigation and to convey the tributary flows. However, the potential for the stream to reoccupy the pre-November 2005 flood alignment - which is tributary to the existing culverts - is anticipated to occur within the service life of the culvert. Therefore, it is recommended that this culvert be sized to convey all flows from this tributary. The moderate volume of sediment observed to have deposited at station 652+70 from the November 2005 flood is anticipated to be conveyed through the proposed pipe arch. If necessary, periodic maintenance may be required to clear deposited sediments. At a minimum, a culvert at this location is required to convey overland flows collected by the roadside ditch.

At this phase, preliminary design was completed in support of the Preliminary Engineering Report. Final culvert designs will be prepared and documented for submittal with the Plans-in-Hand.

A 8'-10 by 6'-1" pipe arch is recommended as the replacement at this crossing. This size pipe will satisfy requirements of the Tier 1 stream simulation design method for fish passage as stated in the MOA. This culvert will provide sufficient span to accommodate the downstream channel which varies in width from 8.5 to 9.3 feet measured by the Inter-Fluve survey (November, 2008) and representative of stream conditions locally at the culvert. The culvert would be set at a slope to match the existing stream system. Stream substrate will be placed in the bottom of the pipe to fill a minimum of 20 percent of the rise. Concepts are shown in Section 23.3.

Existing and proposed conditions were modeled with HEC-RAS. Results of modeling indicate that the proposed culvert will pass the 50-year flood with headwater elevation to culvert rise ratio equal to 1.15.

Table 11-1. 647+20 Hydrologic and Hydraulic Summary

Drainage Area = 1.75-square miles

Exceedance probability	10%	2%	1%
Return period	10-year (Q10)	50-year (Q50)	100-year (Q100)
Design discharge (cfs) full tributary flow	174	255	291
Flow depth at inlet (ft)	4.06	5.58	6.20
Hw/D	0.84	1.15	1.28

Note: Design was completed to preliminary level in support of the Preliminary Engineering Report based on site survey data collected by DOWL HKM and Inter-Fluve based on a project horizontal and vertical datum.

11.5 23 CFR

There is no known FEMA Flood Insurance Study for the existing culvert. The proposed action includes a culvert larger in size and more hydraulically efficient than the existing culverts. The location of the tributary is dynamic therefore it is assumed that during its service life this culvert will once again need to convey full tributary flows. Hydraulic analysis of full tributary flows indicates that the upstream water surface elevations will be lower with the proposed culvert than currently exist. Risks of the proposed culvert are considered minimal. There is a reduction in upstream backwater effects and more efficient conveyance of flows through the pipe. There is less likelihood of debris blocking the culvert. Volumes of sediment deposition near the road are considered to be moderate enough that they will pass through the proposed culvert or can be managed with periodic maintenance. The proposed culvert will improve stream process and provide more natural flood plain connectivity.

11.6 Conclusion

The hydraulic features of the proposed action are developed to a preliminary level at this phase in support of the Preliminary Engineering Report. Design will be completed for submittal with Plans-in-Hand. The proposed culvert is not expected to impact the flood plain or environment. The proposed culvert was designed for fish passage using the Tier 1 method to simulate adjacent stream conditions. This provides favorable continuity of stream processes and passage of fish through the culvert from adjacent stream reaches.

The hydrologic and hydraulic summary for the proposed culvert are presented in Table 11-1.

11.7 Riprap

The culvert was designed using Tier 1 stream simulation to maintain continuity of flow of water and sediment. No riprap is proposed at this time.

11.8 Station 647+20 – Existing conditions photos

Existing Culverts: 2 – 36-inch cmp

Catalog Number: 115-32-10250-2040

Fish Use: Rearing coho and Dolly Varden. Spawning pink salmon

Description: This location was referenced as Station 670+00 in the S&HI. Based on hand measurements, upstream of the culverts the stream splits almost immediately. The minor branch runs in a roadside ditch up to near (S&HI) station 680+30 where it turns away from the road. The section along the road is an E type channel 2' wide and +1' deep. The banks are vegetated with grasses that frequently overhang the full width of the stream. Substrate is gravel. Where it cuts away from the road, this section of the stream broadens and winds through established forest. The major branch of the stream is gravel bottomed and meanders away from the road in a stable bed with well forested banks. Downstream, the culverts empty into a broad 15' by 20' pool that leads into a 4-8' wide E-channel backwatered at times by a beaver dam and the influence of a side channel of the river. The stream joins the river near (S&HI) station 668+40. The stream banks are predominantly grass, with some willow. At times, the stream flows directly along the toe of the road fill. The lower section of the stream is much less well vegetated than the upper portion.



12. Culvert Installation at Station 652+70

The crossing structure at this site is pending design of a mitigation channel that will extend through the culvert to provide fish passage and conveyance of flood and debris along 13-Mile Creek.

12.1 Introduction

This tributary is referred to locally as 13-Mile Creek. The existing culvert crossing of the highway for this tributary is located at station 647+20 (S&HI station 670+00). A flood in November 2005 relocated the creek alignment to impinge the highway at station 652+70. At the highway, flows split to both the north and the south along the roadside ditch. It is proposed to place a culvert at station to convey flow and debris across the highway into a mitigation channel to be constructed and connect to the existing stream exiting the station 647+20 culvert. The mitigation channel is under development and will have an affect on the hydraulics through the proposed culvert. Thus, the details of the proposed culvert crossing are pending. Considering that the proposed 8'-10" by 6'-1" pipe arch culvert at station 647+20 was designed to convey full stream flows and meet Tier 1 stream simulation criteria; it is anticipated a similar structure will be required at this site..

12.2 Hydraulic History

This section will be completed pending finalizing the mitigation channel design.

12.3 Hydrology

This section will be completed pending finalizing the mitigation channel design.

12.4 Hydraulic Design

This section will be completed pending finalizing the mitigation channel design.

Table 12-1. 973+30 Hydrologic and Hydraulic Summary

This section will be completed pending finalizing the mitigation channel design.

12.5 23 CFR

This section will be completed pending resolution of debris flow considerations.

12.6 Conclusion

This section will be completed pending finalizing the mitigation channel design.

12.7 Riprap

This section will be completed pending finalizing the mitigation channel design.

13. Culvert Replacement at Station 710+75

13.1 Introduction

This tributary is referred to locally as 14-Mile Creek. The tributary crosses the highway at station 710+75 (S&HI station 731+00) near a local unimproved boat ramp. The crossing is comprised of two 36-inch circular corrugated metal pipes (CMP). The bottoms of the pipes are rusted and the pipes should be replaced. At this Preliminary Engineering Report phase, the replacement pipe was preliminarily designed to meet Tier 1 stream simulation fish passage methods as outlined in the MOA and site cover restrictions. Tier 1 methods were selected based on the high quality of upstream habitats. This project will replace the existing pipes with a larger 12'-7" by 8'-4" pipe arch to convey flood flows, provide fish passage and meet site cover restrictions.

13.2 Hydraulic History

14-Mile Creek crosses the Haines Highway at about elevation 49.5-ft. As described in Section 4.3.1, MHHW is at elevation 9.4-ft (NAVD 88) and based on approximate modeling tidal backwater will not extend to this location.

14-Mile Creek flows 150-ft from the culvert outlet before entering a side channel of the Chilkat River. The culvert is actively backwatered and frequently submerged by flows along this side channel

No historical flood data are available for this tributary. Magnitude and water surface elevations for the flood of record are not known. High water marks for large flood events were not evident. No Flood Insurance Studies were identified for the Chilkat River or its tributaries, including this one.

A site visit was conducted on October 8, 2005. A rapid assessment and cursory site survey were conducted for this phase as described in Section 3.2. The existing culverts are two 36-inch diameter circular CMP pipes. Both culverts are at similar elevations and at the time of the survey were nearly submerged by backwater from the Chilkat River side channel. The pipes were clear of debris. The bottoms of the pipes are rusted and the pipes should be replaced for longevity. From the site survey, the pipes are approximately 94-ft long, laid at approximately 0.017-ft/ft slope. Though the culverts were observed to be nearly submerged by backwater, no problems of flooding over the road with the existing culverts were reported in the anecdotal record or indicators observed in the field.

The creek at the culverts and upstream is too small for navigation. The culvert replacement will not impact navigation at the culverts and upstream. No upstream confluences were observed in the vicinity. The confluence with a side channel of the Chilkat River is approximately 150-ft downstream of the culverts. An unimproved boat launch ramp is located immediately downstream of the culverts to provide access to the side channel of the Chilkat River. Maintaining the existing launch conditions, removal of the launch and restoration of the stream and relocation or improvement of the launch

facilities are currently under consideration. No other impacts to confluences are expected. No mining occurs on this stream.

Reach scale geomorphic conditions were summarized in the Stream and Habitat Inventory (S&HI) based on observations and simple tape measurements by hand. On the reach scale, the upstream channel is 8-10' wide and leads into a vegetated meadow. Stream banks are stable and vegetated with grasses and willow. The substrate is loose silt and organic matter. There is some backwatering by the river. The outlets of the culverts are nearly submerged even at low river levels and empty into a large, deep pool that acts as both a rearing area for fish and a boat launch site. The pool empties into the river via a short channel. There is some overhanging vegetation on one side of the pool. Substrate is sand and silt.

The S&HI indicates that this stream is used by coho and Dolly Varden as spawning and rearing habitat. Pink and chum use this stream for spawning habitat. The stream is listed in the Anadromous Waters Catalog as catalog number: 115-32-10250-2044.

13.3 Hydrology

14-Mile Creek has a drainage area of approximately 2.26 square miles, the largest of the tributary basins. The high point of the basin is at 5,664 feet at the summit of an unnamed peak. The watershed has an average slope of 51 percent. The USGS 7.5 minute topographical map depicts a perennial stream with two major forks extending to the headwaters. Each branch is fed by lakes in the upper basin. Lake storage comprises less than 1 percent of the basin area. Expansive glaciers cover the east side of the divide, but no glaciers are located on the west side in the basin area. The stream enters the Chilkat side channel further south than depicted on the USGS map. Flow on the valley floor is likely supplemented by hill slope seeps and possibly by hyporheic flow from the Chilkat side channel. The watershed is undeveloped.

There is no known gage information for this stream. Peak flow estimates using regional regression equations ranged from 125 cfs for the 2-year event to 381 cfs for the 100-year flood. The fish passage design flow, which is 40 percent of the 2-year event, is 50 cfs. There is no local input to report for this basin.

13.4 Hydraulic Design

At this phase, preliminary design was completed in support of the Preliminary Engineering Report. Final designs will require detailed stream cross section and profile survey. Final culvert designs will be prepared and documented for submittal with the Plans-in-Hand.

A 12'-7" by 8'-4" pipe arch is recommended as the replacement to accommodate stream width at this crossing and to meet site cover restrictions. This size pipe will satisfy requirements of the Tier 1 stream simulation design method for fish passage as stated in the MOA. This culvert will provide sufficient span to accommodate the 14-ft wide reference stream channel width measured 18 feet upstream of the culvert by the Inter-

Fluve survey (October, 2005)) and representative of stream conditions locally at the culvert. The culvert would be set at a slope to match the existing stream system. Stream substrate will be placed in the bottom of the pipe arch to fill a minimum of 20-percent of the rise. Concepts are shown in Section 23.3.

Existing and proposed conditions were modeled with HEC-RAS. Model boundary conditions assumed normal flow depth based on downstream gradient (slope = 0.002-ft/ft) with no backwater by the Chilkat River. Results of modeling indicate that the proposed culvert will pass the 50-year flood with headwater elevation to culvert rise ratio equal to 0.71.

Table 13-1. 710+75 Hydrologic and Hydraulic Summary

Drainage Area = 2.26-square miles

Exceedance probability	10%	2%	1%
Return period	10-year (Q10)	50-year (Q50)	100-year (Q100)
Design discharge (cfs)	228	334	381
Flow depth at inlet (ft)	3.09	4.76	5.34
Hw/D	0.46	0.71	0.80

Note: Design was completed to preliminary level in support of the Preliminary Engineering Report based on cursory survey data collected by Inter-Fluve based on a relative horizontal and vertical datum. Final design will include site topographic survey.

13.5 23 CFR

There is no known FEMA Flood Insurance Study for the existing culvert. The proposed action includes a culvert larger in size and more hydraulically efficient than the existing culvert. Hydraulic analysis indicates that the upstream water surface elevations will be lower with the proposed culvert than currently exist. Risks of the proposed culvert are considered minimal. There is a reduction in upstream backwater effects and more efficient conveyance of flows through the pipe. There is less likelihood of debris blocking the culvert. The proposed culvert will improve stream process and provide more natural flood plain connectivity.

13.6 Conclusion

The hydraulic features of the proposed action are developed to a preliminary level at this phase in support of the Preliminary Engineering Report. Design will be completed for submittal with Plans-in-Hand. The proposed culvert is not expected to impact the flood plain or environment. The proposed culvert meets ADOT&PF's requirements for conveyance of the 50-year event. The proposed culvert was designed for fish passage using the Tier 1 method to simulate adjacent stream conditions. Tier 1 methods were selected based on the high quality of upstream habitats. This provides favorable continuity of stream processes and passage of fish through the culvert from adjacent stream reaches.

The hydrologic and hydraulic summary for the proposed culvert are presented in Table 13-1.

13.7 Riprap

The culvert was designed using Tier 1 stream simulation to maintain continuity of flow of water and sediment. This stream has a very flat gradient and low energy. No riprap is proposed at this time.

13.8 Station 710+75 – Existing conditions photos

Existing Culverts: 2 – 36-inch cmp

Catalog Number: 115-32-10250-2044

Fish Use: Rearing and spawning coho and Dolly Varden

Description: This location was referenced as Station 731+00 in the S&HI. Based on hand measurements, upstream of the culverts the stream is 8-10' wide and leads into a vegetated meadow. Stream banks are stable and vegetated with grasses and willow. The substrate is loose silt and organic matter. There is some backwatering by the river. The outlets of the culverts are nearly submerged even at low river levels and empty into a large, deep pool that acts as both a rearing area for fish and a boat launch site. The pool empties into the river via a short channel. There is some overhanging vegetation on one side of the pool. Substrate is sand and silt.



14. Culvert Replacement at Station 865+88

14.1 Introduction

This tributary, locally referred to as 17-Mile Creek, crosses the highway at station 865+88 (S&HI station 886+00). The crossing is comprised of an existing 6'-1"x4'7" pipe arch. The bottom of the pipe is stained and rusted and the pipe should be replaced for longevity. At this Preliminary Engineering Report phase, the pipe was preliminarily designed to meet Tier 1 stream simulation fish passage methods and site cover restrictions. Tier 1 methods were selected based on the high quality of upstream habitats and ground water source. The stream immediately above the road is ponded through an excavated area along the road embankment with a free flowing reach immediately upstream that is an average of 12.6-ft wide. This project will replace the existing pipe with a larger 11'-7" by 7'-5" pipe arch to convey flood flows, provide fish passage and site cover restrictions. The location of the culvert will be moved to approximately station 869+00 to accommodate a new stream alignment as one component of project mitigation.

14.2 Hydraulic History

17-Mile Creek crosses the Haines Highway at about elevation 67-ft. As described in Section 4.3.1, MHHW is at elevation 9.4-ft (NAVD 88) and based on approximate modeling tidal backwater will not extend to this location. This tributary flows approximately 60-ft to a minor side channel of the Chilkat River. The culvert experiences some backwater by flows along this side channel

No historical flood data are available for this tributary. Magnitude and water surface elevations for the flood of record are not known. High water marks for large flood events were not evident. No Flood Insurance Studies were identified for the Chilkat River or its tributaries, including this one.

A site visit was conducted on October 8, 2005. A rapid assessment and cursory site survey were conducted for this phase as described in Section 3.2. The existing culvert is a 6'-1"x4'7" pipe arch. The outlet is perched about 0.25-ft above the water surface elevation in the downstream scour pool. The pipe appears to have no accumulated sediment in the bottom. The pipe is approximately 72-ft long laid at approximately 0.015-ft/ft slope. No flooding problems with the existing culvert were reported in the anecdotal record or indicators observed in the field.

The creek is too small for navigation. This project will not impact navigation. The confluence with a minor side channel of the Chilkat River is approximately 60-ft downstream. No upstream confluences were observed in the vicinity. No impacts to confluences are expected. No mining occurs on this stream.

Reach scale geomorphic conditions were summarized in the Stream and Habitat Inventory (S&HI). The stream upstream of the culvert is a man-made complex consisting of two distinct branches. The main branch is a spring fed channel that runs along the toe

of the road embankment up to station 871+75 where it ends in a beaver dam or man-made berm. From observations and simple tape measurements by hand, the lower half of this channel is excavated and consistently 8-10' wide and forms a slow moving pool 1-2' deep. The steep banks are vegetated with overhanging grasses. Several springs feed into the channel from under the bank on the mountain side. The upper half of the channel is a 2-3' wide riffle winding through boulders and thickly vegetated with grasses. The second branch of the complex feeds into the main branch about 100' upstream of the culvert inlet. This branch is fed by a series of springs, as well as a mountain stream, and rises in a series of pools and riffles up to a chum salmon incubation box facility operated by the Northern Southeast Regional Aquaculture Association. The stream substrate is gravel/cobble and the banks are well vegetated. Downstream the culvert outlet empties into a large pool used as a holding area for adult chum salmon. Pool substrate is silt covered gravel. A short channel connects the pool to a minor side channel of the Chilkat River.

The S&HI indicates that this stream is used by coho and Dolly Varden as rearing habitat. Chum and coho use this stream as spawning habitat. The stream is listed in the Anadromous Waters Catalog as catalog number: 115-32-10250-2060-3002.

14.3 Hydrology

This stream has a drainage area of approximately 0.8 square miles. The high point of the basin is at 5,608 feet at the summit of an unnamed peak. The watershed has an average slope of 57 percent. The USGS 7.5 minute topographical map depicts a perennial stream that branches midway up the basin. There is virtually no storage in the basin and there are no glaciers. The man-made channel running along the road is fed by hill slope seeps and possibly by hyporheic flow from the Chilkat side channel. The watershed is undeveloped.

There is no known gage information for this stream. Peak flow estimates using regional regression equations ranged from 55 cfs for the 2-year event to 169 cfs for the 100-year flood. The fish passage design flow, which is 40 percent of the 2-year event, is 22 cfs. There is no local input to report for this basin.

14.4 Hydraulic Design

At this phase, preliminary design was completed in support of the Preliminary Engineering Report. Final designs will require detailed stream cross section and profile survey. Final culvert designs will be prepared and documented for submittal with the Plans-in-Hand.

A 11'-7" by 7'-5" pipe arch would be required to accommodate stream width for Tier 1 stream simulation fish passage per the MOA at this crossing and meet site cover restrictions. This culvert will provide sufficient span to accommodate the 12.6-ft wide reference stream channel width measured along a free flowing reach approximately 105 feet upstream of the existing culvert by the Inter-Fluve survey (October, 2005) and representative of stream conditions locally at the culvert under the relocated mitigation channel conditions. The culvert would be set at a slope to match the existing stream

system. Stream substrate will be placed in the bottom of the pipe to fill a minimum of 20-percent of the rise. Concepts are shown in Section 23.3.

Existing and proposed conditions were modeled with HEC-RAS. Results of modeling indicate that the proposed culvert will pass the 50-year flood with headwater elevation to culvert rise equal to 0.43.

Table 14-1. 865+88 Hydrologic and Hydraulic Summary

Drainage Area = 0.80-square miles

Exceedance probability	10%	2%	1%
Return period	10-year (Q10)	50-year (Q50)	100-year (Q100)
Design discharge (cfs)	101	148	169
Flow depth at inlet (ft)	1.61	2.11	2.33
HW/D	0.33	0.43	0.47

Note: Design was completed to preliminary level in support of the Preliminary Engineering Report based on cursory survey data collected by Inter-Fluve based on a relative horizontal and vertical datum. Final design will include site topographic survey.

14.5 23 CFR

There is no known FEMA Flood Insurance Study for the existing culvert. The proposed action includes a culvert larger in size and more hydraulically efficient than the existing culvert. Hydraulic analysis indicates that the upstream water surface elevations will be lower with the proposed culvert than currently exist. Risks of the proposed culvert are considered minimal. There is a reduction in upstream backwater effects and more efficient conveyance of flows through the pipe. There is less likelihood of debris blocking the culvert. The proposed culvert and proposed channel relocation for mitigation will improve stream process and provide more natural flood plain connectivity.

14.6 Conclusion

The hydraulic features of the proposed action are developed to a preliminary level at this phase in support of the Preliminary Engineering Report. Design will be completed for submittal with Plans-in-Hand. The proposed culvert is not expected to impact the flood plain or environment. The proposed culvert meets ADOT&PF’s requirements for conveyance of the 50-year event. The proposed culvert was designed for fish passage using the Tier 1 method to simulate adjacent stream conditions. This provides favorable continuity of stream processes and passage of fish through the culvert from adjacent stream reaches.

The hydrologic and hydraulic summary for the proposed culvert are presented in Table 14-1.

14.7 Riprap

The culvert was designed to provide fish passage using Tier 1 stream simulation to maintain continuity of flow of water and sediment. No riprap is proposed at this time.

14.8 Station 865+88 – Existing conditions photos

Existing Culvert: 6'-1" x 4'-7" pipe arch

Catalog Number: 115-32-10250-3002

Fish Use: Rearing coho and Dolly Varden. Spawning chum and coho

Description: This location was referenced as Station 886+00 in the S&HI. The stream upstream of the culvert is a man-made complex consisting of two distinct branches. The main branch is a spring fed channel that runs up to 2009 station 871+75 where it ends in a beaver dam or man-made berm. Based on hand measurements, the lower half of this channel is excavated with a consistent 8-10' width and forms a slow moving pool 1-2' deep. The steep banks are vegetated with overhanging grasses. Several springs feed into the channel from under the bank on the mountain side. The upper half of the channel is a 2-3' wide riffle winding through boulders and thickly vegetated with grasses. The second branch of the complex feeds into the main branch about 100' upstream of the culvert inlet. This branch is fed by a series of springs, as well as a mountain stream, and rises in a series of pools and riffles up to a chum salmon incubation box facility operated by the Northern Southeast Regional Aquaculture Association. The stream substrate is gravel/cobble and the banks are well vegetated. Downstream, the culvert outlet empties into a large pool used as a holding area for adult chum salmon. The pipe is perched 4". Pool substrate is silt covered gravel. A short channel connects the pool to a side channel of the Chilkat River.



15. Culvert Replacement at Station 887+60

15.1 Introduction

This tributary, locally known as Horse Farm Creek, crosses the new highway alignment approximately at station 895+75 (S&HI station 917+00) near a private grass airstrip. The existing crossing is comprised of two 36-inch circular corrugated metal pipes (CMP) along a stream averaging 4 to 6 feet wide. The highway will be realigned with the new crossing at (2009) station 887+60 approximately 1,000 feet downstream of the existing crossing. The stream at the new location is approximately 9 feet wide about 125 feet upstream of the confluence with Eighteen Mile Slough, a minor side channel of the Chilkat River. At this Preliminary Engineering Report phase, the replacement pipe was preliminarily designed to meet Tier 1 stream simulation fish passage methods and site cover restrictions. Tier 1 methods were selected based on the heavy utilization of high quality upstream habitats. This project will place a 9'-4" by 6'-3" pipe arch at the stream crossing of the new highway alignment to convey flood flows and provide fish passage. The existing pipes may be removed and the stream day lighted as part of project mitigation.

15.2 Hydraulic History

Horse Farm Creek will cross the new Haines Highway location at about elevation 65-ft. As described in Section 4.3.1, MHHW is at elevation 9.4-ft (NAVD 88) and based on approximate modeling tidal backwater will not extend to this location. The new highway alignment is approximately 70 feet upstream of the confluence of, and is backwatered by, Eighteen Mile Slough, a minor side channel of the Chilkat River.

No historical flood data are available for this tributary. Magnitude and water surface elevations for the flood of record are not known. High water marks for large flood events were not evident. This reach of Horse Farm Creek is directly backwatered by Eighteen Mile Slough. No Flood Insurance Studies were identified for the Chilkat River or its tributaries, including this one.

During a flood in November 2005, a significant volume of sand was deposited at the existing culvert and along the stream. During a site visit in May 2008 the sand was observed to have largely been transported from the system.

A site visit of the existing culverts was conducted on October 8, 2005. A rapid assessment and cursory site survey of the existing culverts were conducted for this phase as described in Section 3.2. The existing culverts are two 36-inch diameter circular CMPs. Both culverts are at similar elevations and at the time of the survey were nearly submerged. Approximately 0.8- to 1.4-ft of material was measured in the bottom of the 36-inch pipes. The bottoms of the pipes are rusted and - should this road be kept in service for access to private property – the pipes should be replaced for longevity. A decision on access and fate of this culvert has not been made at this time. Therefore, a replacement pipe to provide access has not been designed at this time. From the site

survey, the pipes are approximately 58-ft long and average 0.015-ft/ft slope. The culverts were observed to have no scour pool or be perched. No flooding problems with the existing culvert were reported in the anecdotal record or indicators observed in the field. The proposed highway alignment is located downstream approximately 1,000 feet. Additional survey in this area was collected in November 2008 and May 2009. The current design alignment is similar to that shown in the companion 2006 Stream and Habitat Inventory (S&HI).

The creek is too small for navigation. This project will not impact navigation. The confluence with Eighteen Mile Slough, a minor side channel of the Chilkat River, is approximately 70 feet downstream of the proposed highway alignment. No upstream confluences were observed in the vicinity. No impacts to confluences are expected. No mining occurs on this stream.

Reach scale geomorphic conditions were summarized in the Stream and Habitat Inventory (S&HI) from observations and simple tape measurements by hand. The channel upstream of the existing highway crossing is a fast 4-6% continuous riffle with a rocky substrate. The stream is 4-6' wide and meanders through a young forest. Downstream of the culverts the stream meanders along the existing road, intersecting the new alignment centerline at station 887+60. The roughly 1200' of stream between the culvert outlet and the confluence with Eighteen Mile Slough can be approximately divided by habitat type into three reaches. The first 400' section, measured from the culvert outlet downstream, is a 4-6' wide E-channel composed primarily of riffles, with a substrate of gravel. Although it is of similar width, the second 400' section is flatter in gradient and more complex, composed of riffles combined with numerous deep pools associated with the root structures of well established vegetation. The substrate of this reach is more silt/organic, although the November 2005 flood did deposit a good deal of gravel. The downstream reach connecting to the slough widens to a maximum width of 15' and is subject to backwatering when the Chilkat River is high. The stream substrate is silt, and the banks are steep and well vegetated. Two small streams draining adjacent wetlands enter Horse Farm Creek from the west.

The S&HI indicates that this stream is used by coho and Dolly Varden as spawning and rearing habitat. Pink and coho use this stream for spawning habitat. The stream is listed in the Anadromous Waters Catalog as catalog number: 115-32-10250-2060-3001.

15.3 Hydrology

This stream has a drainage area of approximately 1.55 square miles. The high point of the basin is at 5,621 feet at the summit of an unnamed peak. The watershed is steep, with an average slope of 64 percent. The USGS 7.5 minute topographical map depicts a perennial stream with 3 branches midway up the basin. There is virtually no storage and there are no glaciers. The lower 500 meters of stream channel flows along the eastern edge of the large Nineteen-Mile Debris Fan and possibly loses flow to this feature. There is a small airstrip adjacent to the lower portion of the stream downstream of the existing culvert and

upstream of the proposed crossing, but no development within the drainage area contributing to the culvert itself.

There is no known gage information for this stream. Peak flow estimates using regional regression equations ranged from 95 cfs for the 2-year event to 291 cfs for the 100-year flood. The fish passage design flow, which is 40 percent of the 2-year event, is 38 cfs. There is no local input to report for this basin.

15.4 Hydraulic Design

At this phase, preliminary design was completed in support of the Preliminary Engineering Report. Basic topographic data at the new alignment stream crossing was surveyed in November 2008. Final culvert designs will be prepared and documented for submittal with the Plans-in-Hand.

A 9'-4" by 6'-3" pipe arch is recommended for the stream crossing of the proposed highway alignment. This size pipe will satisfy site cover restrictions and requirements of the Tier 1 stream simulation design method for fish passage as stated in the MOA. This culvert will provide sufficient span to accommodate the 8.3-ft wide reference stream channel width measured along a free flowing reach approximately 90 feet upstream of the new highway crossing by the Inter-Fluve survey (November 2008) and is representative of stream conditions locally to the new crossing. The culvert would be set at a slope to match the existing stream system. Stream substrate will be placed in the bottom of the pipe to fill a minimum of 20-percent of the rise. Concepts are shown in Section 23.3.

Existing and proposed conditions were modeled with HEC-RAS. Results of modeling indicate that the proposed culvert will pass the 50-year flood with headwater elevation to culvert rise ratio equal to 1.17.

Table 15-1. 887+60 Hydrologic and Hydraulic Summary

Drainage Area = 1.55-square miles

Exceedance probability	10%	2%	1%
Return period	10-year (Q10)	50-year (Q50)	100-year (Q100)
Design discharge (cfs)	175	255	291
Flow depth at inlet (ft)	4.06	5.86	6.65
Hw/D	0.81	1.17	1.33

Note: Design was completed to preliminary level in support of the Preliminary Engineering Report based on basic topographic survey data collected November 2008 and based on project horizontal and vertical datum. Final design may require additional site topographic survey.

15.5 23 CFR

There is no known FEMA Flood Insurance Study for the existing culvert. The proposed action includes a culvert to be placed where none currently exists. Hydraulic modeling

based on total station topography indicate that water surface elevations for the 50- and 100-year events will increase by nearly 1.62 and 2.26 feet, respectively. The site survey and, LIDAR topography and aerial photography indicate that adjacent land uses is low-lying undeveloped forest and wetland. The 100-year water surface elevation at the inlet of the proposed culvert is 72.2 feet, 4.8 feet lower than the end of the nearby runway. Increases in water surface elevations are not expected to encroach onto the nearby air strip. Risks of the proposed culvert are considered minimal.

15.6 Conclusion

The hydraulic features of the proposed action are developed to a preliminary level at this phase in support of the Preliminary Engineering Report. Design will be completed for submittal with Plans-in-Hand. The proposed culvert is not expected to impact the flood plain or environment.

The hydrologic and hydraulic summary for the proposed culvert are presented in Table 15-1.

15.7 Riprap

No riprap is proposed at this time.

15.8 Station 887+60 – Existing conditions photos

Existing Culverts: 2 – 36-inch cnp

Catalog Number: 115-32-10250-2060-3001

Fish Use: Rearing coho and Dolly Varden. Spawning pink and coho

Description: The existing location of stream crossing of the highway was referenced as Station 917+00 in the S&HI. Upstream of the culverts the stream is a fast 4-6% continuous riffle with a rocky substrate. The stream is 4-6' wide and meanders through a young forest. Downstream of the culverts the stream meanders along the existing road, intersecting the new alignment centerline at (2009) station 887+60. The roughly 1200' of stream between the culvert outlet and the confluence with Eighteen Mile Slough can be approximately divided by habitat type into three reaches. The first 400' section, measured from the culvert outlet downstream, is a 4-6' wide E-channel composed primarily of riffles, with a substrate of gravel. Although it is of similar width, the second 400' section is flatter in gradient and more complex, composed of riffles combined with numerous deep pools associated with the root structures of well established vegetation. The substrate of this reach is more silt/organic, although the November 2005 flood did deposit a good deal of gravel. The downstream reach connecting to the slough widens to a maximum width of 15' and is subject to backwatering when the Chilkat River is high. The stream substrate is silt, and the banks are steep and well vegetated. Two small streams draining adjacent wetlands enter Horse Farm Creek from the west.

Station 917+00 – Existing conditions photos (cont'd)



16. Culvert Replacement at Station 962+06

The crossing structure at this site is pending design during the Draft DSR phase and is anticipated to consist of a large box culvert to facilitate removal of deposited sediment utilizing equipment.

16.1 Introduction

This tributary is located along a debris flow at highway station 962+06 (S&HI station 983+25). The existing crossing is comprised of an 8'-2" by 5'-9" pipe arch. Design will be completed by DOWL HKM during the Draft DSR phase to facilitate equipment access for clearing of debris flow sediments and is anticipated to include a large box culvert. Hydrology and Hydraulic design for flood conveyance and fish passage will be completed accordingly during the Draft DSR phase.

16.2 Hydraulic History

This section will be completed pending resolution of debris flow considerations.

16.3 Hydrology

This section will be completed pending resolution of debris flow considerations.

16.4 Hydraulic Design

This section will be completed pending resolution of debris flow considerations.

Table 16-1. 962+06 Hydrologic and Hydraulic Summary

This section will be completed pending resolution of debris flow considerations.

16.5 23 CFR

This section will be completed pending resolution of debris flow considerations.

16.6 Conclusion

This section will be completed pending resolution of debris flow considerations.

16.7 Riprap

This section will be completed pending resolution of debris flow considerations.

16.8 Station 962+06 – Existing conditions photos

Existing Culvert: 8' – 2" x 5' – 9" pipe arch

Fish Use: Rearing coho and Dolly Varden

Description: This location was referenced as Station 983+25 in the S&HI. This stream is part of the 19 mile slide area and is subject to alteration by the periodic influx and mechanical removal of large quantities of slide material. This material consists of fine decomposed rock and gravels mixed with cobbles. The stream above the culvert runs in an open ditch along the road back to (2009) station 958+00. No vegetation is present yet numerous juvenile fish were seen in the stream. The stream turns away from the road and runs toward the mountain for about 75' before any upstream movement of fish is prevented by a barrier falls. Downstream of the culvert the stream is braided and open until it intersects the woods several hundred feet below the pipe. The substrate is slide material and initially there is little vegetation. Once the stream enters the woods it is a 2-3' wide fast riffle until it empties into a series of riverside pools fed by upwelling water.



17. Culvert Replacement at Station 973+30

The crossing structure at this site is pending design during the Draft DSR phase and is anticipated to consist of a large box culvert to facilitate removal of deposited sediment utilizing equipment.

17.1 Introduction

This tributary is located along a debris flow at highway station 973+30 (S&HI station 994+50). The crossing is comprised of a 9'-9" by 6'-9" pipe arch. Design will be completed by DOWL HKM during the Draft DSR phase to facilitate equipment clearing debris flow sediments and is anticipated to include a large box culvert. Hydrology and Hydraulic design for flood conveyance and fish passage will be completed accordingly during the Draft DSR phase.

17.2 Hydraulic History

This section will be completed pending resolution of debris flow considerations.

17.3 Hydrology

This section will be completed pending resolution of debris flow considerations.

17.4 Hydraulic Design

This section will be completed pending resolution of debris flow considerations.

Table 17-1. 973+30 Hydrologic and Hydraulic Summary

This section will be completed pending resolution of debris flow considerations.

17.5 23 CFR

This section will be completed pending resolution of debris flow considerations.

17.6 Conclusion

This section will be completed pending resolution of debris flow considerations.

17.7 Riprap

This section will be completed pending resolution of debris flow considerations.

17.8 Station 973+30– Existing conditions photos

Existing Culvert: 9'– 9" x 5'– 9" pipe arch

Fish Use: Unknown

Description: This location was referenced as Station 994+50 in the S&HI. The stream above the culvert of this 19 mile slide stream is very unstable and often excavated by heavy equipment. Substrate is mobile slide material. Some vegetation is beginning to be established on the banks. Fish passage above the culvert is blocked by a headcut upstream 200'. Downstream of the culvert the stream is initially a braided riffle with little sign of viable fish habitat. Two hundred feet downstream of the culvert outlet the stream becomes a steep cascade through boulders until it enters the river.



18. Culvert Replacement at Station 1102+19

18.1 Introduction

This tributary is locally referred to as 21-1/2 Mile Creek and crosses the highway at station 1102+19 (S&HI station 1123+25). The crossing, immediately downriver of the turn off to the village of Klukwan, is comprised of an existing circular 36-inch corrugated metal pipe (CMP). At this Preliminary Engineering Report phase, the pipe was preliminarily designed based on Tier 1 stream simulation methods outlined in the MOA. Tier 1 methods were selected based on fair to good upstream habitats and to provide continuity of flow, sediment and debris through the pipe. This project will replace the existing pipe with a larger 7'-3" by 5'-3" pipe arch to convey flood flows and provide fish passage.

18.2 Hydraulic History

This unnamed tributary crosses the Haines Highway at about elevation 117-ft. As described in Section 4.3.1, MHHW is at elevation 9.4-ft (NAVD 88) and based on approximate modeling tidal backwater will not extend to this location. The low flow water level in adjacent reaches of the Chilkat River are at approximately elevation 108-ft. It is unlikely that Chilkat River flows will have a backwater impact extending to the culvert location.

No historical flood data are available for this tributary. Magnitude and water surface elevations for the flood of record are not known. High water marks for large flood events were not evident. No Flood Insurance Studies were identified for the Chilkat River or its tributaries, including this one.

A site visit was conducted on October 8, 2005. A rapid assessment and cursory site survey were conducted for this phase as described in Section 3.2. The existing culvert is a 36-inch CMP with no stream substrate material in the bottom of the pipe. From the site survey, the existing pipe is approximately 66-ft long at approximately 0.057-ft/ft slope. The tributary streambed slope is 0.038-ft/ft upstream and 0.007-ft/ft downstream of the culvert. A small amount of flow was observed. No flooding problems with the existing culvert were reported in the anecdotal record or indicators observed in the field.

The creek is too small for navigation. This project will not impact navigation. The confluence with the Chilkat River is approximately 1,500-ft downstream. No upstream confluences were observed in the vicinity. Therefore, no impacts to confluences are expected. No mining occurs on this stream.

Reach scale geomorphic conditions were summarized in the Stream and Habitat Inventory (S&HI) from observations and simple tape measurements by hand. The channel upstream of the existing highway crossing is 1-2' wide and composed of riffle habitat. The stream runs alongside the road up to (2009) station 1107+00 before the channel turns away from the road. For the first 150' above the culvert the stream lies

away from the toe of the road fill slope and cover is provided by adjacent willow and alder. The stream then runs tight along the toe and the banks are vegetated with grasses. Downstream of the culvert the stream flows through a manipulated habitat with patches of willow and grasses beginning to be established. For both portions of the stream the substrate is small gravel.

The S&HI indicates that this stream is used by coho and Dolly Varden as rearing habitat. Chum and coho use this stream for spawning habitat. The stream is listed in the Anadromous Waters Catalog as catalog number: 115-32-10250-2070.

18.3 Hydrology

This stream has a drainage area of approximately 1.26 square miles. The high point of the basin is at 5,477 feet on a ridge leading north toward Iron Mountain. The watershed has an average slope of 54 percent. The USGS 7.5 minute topographical map depicts a single perennial stream channel extending only one third of the way up the basin. There is no storage and there are no glaciers. The lower 1,000 yards of stream flows along the eastern edge of the large Twenty-three mile debris fan and likely loses flow to this feature. There is a water tank in the lower portion of the basin that supplies the village of Klukwan. Otherwise, the watershed is undeveloped.

There is no known gage information for this stream. Peak flow estimates using regional regression equations ranged from 73 cfs for the 2-year event to 227 cfs for the 100-year flood. The fish passage design flow, which is 40 percent of the 2-year event, is 29 cfs. There is no local input to report for this basin.

18.4 Hydraulic Design

At this phase, preliminary design was completed in support of the Preliminary Engineering Report. Final designs will require detailed stream cross section and profile survey. Final culvert designs will be prepared and documented for submittal with the Plans-in-Hand.

A 7'-3" by 5'-3" pipe arch is recommended as the replacement at this crossing. This size pipe will satisfy requirements of the Tier 1 stream simulation design method for fish passage as stated in the MOA. This culvert will provide sufficient span to accommodate the 6.6-ft wide reference stream channel width measured 60 feet upstream of the culvert by the Inter-Fluve survey (October, 2005) and is representative of stream conditions locally at the culvert. The culvert would be set at a slope to match the existing stream system. Stream substrate will be placed in the bottom of the pipe to fill a minimum of 20-percent of the rise. Concepts are shown in Section 23.3.

Existing and proposed conditions were modeled with HEC-RAS. Results of modeling indicate that the proposed culvert will pass the 50-year flood with headwater elevation to culvert rise ratio equal to 1.46.

Table 18-1. 1102+19 Hydrologic and Hydraulic Summary

Drainage Area = 1.26-square miles

Exceedance probability	10%	2%	1%
Return period	10-year (Q10)	50-year (Q50)	100-year (Q100)
Design discharge (cfs)	135	198	227
Flow depth at inlet (ft)	4.55	6.15	6.81
Hw/D	1.08	1.46	1.62

Note: Design was completed to preliminary level in support of the Preliminary Engineering Report based on cursory survey data collected by Inter-Fluve based on a relative horizontal and vertical datum. Final design will include site topographic survey.

18.5 23 CFR

There is no known FEMA Flood Insurance Study for the existing culvert. The proposed action includes a culvert larger in size and more hydraulically efficient than the existing culvert than currently exist. Risks of the proposed culvert are considered minimal. There is a reduction in upstream backwater effects and more efficient conveyance of flows through the pipe. There is less likelihood of debris blocking the culvert. The proposed culvert will improve stream process and provide more natural flood plain connectivity.

18.6 Conclusion

The hydraulic features of the proposed action are developed to a preliminary level at this phase in support of the Preliminary Engineering Report. Design will be completed for submittal with Plans-in-Hand. The proposed culvert is not expected to impact the flood plain or environment. The proposed culvert meets ADOT&PF's requirements for conveyance of the 50-year event. The proposed culvert was designed for fish passage using the Tier 1 method to simulate adjacent stream conditions. This provides favorable continuity of stream processes and passage of fish through the culvert from adjacent stream reaches.

The hydrologic and hydraulic summary for the proposed culvert are presented in Table 18-1.

18.7 Riprap

The culvert was designed using Tier 1 stream simulation to maintain continuity of flow of water and sediment. No riprap is proposed at this time.

18.8 Station 1102+19 – Existing conditions photos

Existing Culvert: 36-inch cmp

Catalog Number: 115-32-10250-2070

Fish Use: Rearing coho and Dolly Varden. Spawning chum and coho

Description: This location was referenced as Station 1123+25 in the S&HI. Based on hand measurements, upstream of the culverts the stream is 1-2' wide and composed of riffle habitat. The stream runs alongside the road up to (2009) station 1107+00 before the channel turns away from the road. For the first 150' above the culvert the stream lies away from the toe of the road fill slope and cover is provided by adjacent willow and alder. The stream then runs tight along the toe and the banks are vegetated with grasses. Downstream of the culvert the stream flows through a manipulated habitat with patches of willow and grasses beginning to be established. For both portions of the stream the substrate is small gravel.



19. Culvert Replacement at Station 1179+75

The crossing structure at this site is pending design during the Draft DSR phase and is anticipated to consist of a large box culvert to facilitate removal of deposited sediment utilizing equipment

19.1 Introduction

This tributary is located along a debris flow at highway station 1179+75. The crossing is comprised of a corrugated metal pipe (CMP) about 13-ft in diameter. Design will be completed by DOWL HKM during the Draft DSR phase to facilitate equipment clearing debris flow sediments and is anticipated to include a large box culvert. Hydrology and Hydraulic design for flood conveyance and fish passage will be completed accordingly during the Draft DSR phase

19.2 Hydraulic History

This section will be completed pending resolution of debris flow considerations.

19.3 Hydrology

This section will be completed pending resolution of debris flow considerations.

19.4 Hydraulic Design

This section will be completed pending resolution of debris flow considerations.

Table 19-1. 1179+75 Hydrologic and Hydraulic Summary

This section will be completed pending resolution of debris flow considerations.

19.5 23 CFR

This section will be completed pending resolution of debris flow considerations.

19.6 Conclusion

This section will be completed pending resolution of debris flow considerations.

19.7 Riprap

This section will be completed pending resolution of debris flow considerations.

20. Culvert Replacement at Station 1187+25

The crossing structure at this site is pending design during the Draft DSR phase and is anticipated to consist of a large box culvert to facilitate removal of deposited sediment utilizing equipment

20.1 Introduction

This tributary is located along a debris flow at highway station 1187+25 (approximate S&HI station 1208+25). The crossing is comprised of an 8'-2" by 5'-9" pipe arch. Design will be completed by DOWL HKM during the Draft DSR phase to facilitate equipment clearing debris flow sediments and is anticipated to include a large box culvert. Hydrology and Hydraulic design for flood conveyance and fish passage will be completed accordingly during the Draft DSR phase.

20.2 Hydraulic History

This section will be completed pending resolution of debris flow considerations.

20.3 Hydrology

This section will be completed pending resolution of debris flow considerations.

20.4 Hydraulic Design

This section will be completed pending resolution of debris flow considerations.

Table 20-1. 1187+25 Hydrologic and Hydraulic Summary

This section will be completed pending resolution of debris flow considerations.

20.5 23 CFR

This section will be completed pending resolution of debris flow considerations.

20.6 Conclusion

This section will be completed pending resolution of debris flow considerations.

20.7 Riprap

This section will be completed pending resolution of debris flow considerations.

20.8 Station 1187+25 – Existing conditions photos

Existing Culvert: 8'-2" x 5'-9" pipe arch



21. Small Fish Culverts

21.1 Introduction

Following completion of the field investigations and submittal of the preliminary draft H&H report (November 2005), a number of smaller pipes with fish present were identified. These pipes were either included in the Anadromous Waters Catalog or seen to have fish present by Inter-Fluve or OHMP staff. These pipes are all 36-inches or less in diameter, two sites have double 24-inch CMPs, and are not required to have a hydraulic summary report. However, culvert replacements may require ADF&G Title 16 Fish Habitat Permits. At the request of ADOT&PF, discussion of these culverts and recommendation of design method and culvert size were subsequently added to this report. Therefore, each of these smaller pipes with fish present are identified, existing conditions discussed, H&H analysis/preliminary design presented and size of pipe to meet fish passage and flood conveyance requirements discussed. This section describes methods for providing fish passage and providing flood conveyance equal to or greater than the existing culverts.

21.2 Hydraulic History

Through the anecdotal record and interviews with ADOT&PF maintenance personnel, no culverts were identified that had problems with icing or conveyance of flood flows through unobstructed pipes. Therefore, it is assumed that existing conditions of each pipe discussed below are performing satisfactorily.

21.3 Hydrology

No stream gaging data were identified or known to be available for these streams. Furthermore, the basins range in size from 0.05- to 0.49-sq. mi, all of which fall below the 0.72 sq. mi. threshold to be appropriately evaluated using USGS regression equations for this region. Initially, peak flow estimates were obtained by applying flow per unit area values from neighboring basins. Subsequent hydraulic analysis suggested that these flow estimates were unrealistically large in comparison to the size of the culverts and anecdotal reports of satisfactory flood conveyance. An alternate approach was therefore applied, whereby the discharge associated with a HW/D ratio of 1.5 was loosely approximated as a surrogate for the 50-year flow. Fish passage flows estimated from forty percent of the 2-year USGS regression flow estimate were then prorated based on the ratio of this surrogate and USGS regression estimated 50-year event. In most cases the fish passage flow estimated with this approach had a favorable comparison to the stainline observed on the culvert, an indicator of a frequently occurring flow. Tier 1 stream simulation or Tier 2 FISHPASS program design² fish passage designs were

² Tier 2 FISHPASS program design. This method uses the ADF&G FISHPASS software to determine hydraulic conditions passable by species and age class (size) of fish with sufficiently deep and slow flow to enable fish to pass the full length of culvert within their swimming capabilities (ADF&G and ADOT&PF MOA, 2001).

developed. Lastly, the culvert hydraulic capacity was checked to ensure that flood conveyance equaled or exceeded existing conditions.

21.4 Hydraulic Design

Existing hydraulic capacity was calculated using Federal Highway Administration's HY-8 culvert hydraulic analysis software.

Fish passage was based on Tier 1 stream simulation or Tier 2 FISHPASS program design methods based on recommendations and discussion with ADOT&PF and agency personnel. Tier 2 calculations utilized ADF&G's FISHPASS program for baffled and unbaffled pipes. Design fish were selected as either adults or juvenile Coho or Cutthroat through prior discussion and agreement with ADOT&PF and Agency personnel. A summary of design method used and design fish for Tier 2 applications is included in the culvert summary shown in Appendix 23.4.

A new culvert that would meet fish passage criteria was identified and then resized if necessary to provide equal or greater conveyance capacity than the existing structure. Hydraulic analysis was completed using FHWA HY-8. A comparison of hydraulic capacity for the existing and proposed culverts at each site is presented in Appendix 23.5.3.

Four of the smaller fish pipes are recommended to be integrated with stream improvements during a mitigation phase. These measures will improve fish passage and aquatic habitat (e.g. spawning and rearing). Fish passage and hydraulics of these culverts will be revised at the mitigation phase to incorporate these stream enhancements.

A summary discussion of each site follows.

Station 228+95 (S&HI station 252+00). Tier 2 FISHPASS no baffles

The existing pipe is a 24-inch CMP with a rusted bottom. Elevation is approximately 22-ft. Upstream and downstream conditions are described in the companion Stream and Habitat Inventory (S&HI) and summarized in the following paragraph. Fish passage is designed using Tier 2 FISHPASS methods given the relatively flat gradient and observed ability of fish to pass the existing culvert. FISHPASS analysis indicates that juvenile Coho are able to pass the existing culvert. Therefore, the culvert replacement can be of similar type and elevation as the existing culvert - hydraulic capacity would remain unchanged.

As stated in the S&HI:

Catalog Number: 115-32-10250-2006

Stream Name: Schnabel Creek

Fish Use: Rearing coho, Dolly Varden and cutthroat

Description: Based on observations and hand measurements, upstream of the culvert the stream is 1-2' wide and 1' deep. The stream banks are thickly vegetated with grasses that tend to grow over most of the stream surface. Substrate is organic matter over gravel. The stream runs along the toe of the Southeast Road Builders' fill,

crossing the access driveway at station 269+00 and then connecting to the artificial ponds near S&HI station 260+50. The downstream end of the culvert is submerged in a small pool, with a 2-3' wide E type channel forming almost immediately at the outlet and meandering through the wetlands to connect to another stream. The outlet channel has a very low gradient, a silty bottom and low, vertical banks vegetated with marigolds, sedges and willows.

Station 240+38 (S&HI station 263+50). Tier 2 FISHPASS no baffles

The existing pipe is a 24-inch CMP with a rusted bottom. Elevation is approximately 22-ft. Upstream and downstream conditions are described in the companion S&HI and summarized in the following paragraph. Fish passage is designed using Tier 2 FISHPASS methods given the relatively flat gradient and observed ability of fish to pass the existing culvert. FISHPASS analysis indicates that juvenile Coho are able to pass the existing culvert. Therefore, the culvert replacement can be of similar type and elevation as the existing culvert - hydraulic capacity would remain unchanged.

As stated in the S&HI:

Catalog Number: 115-32-10250-2006-3003

Stream Name: none, listed as tributary to Schnabel Creek

Fish Use: Rearing coho, Dolly Varden and cutthroat

Description: Although the ADFG Catalog lists this stream as a tributary to Schnabel Creek, it is actually a separate system fed by a wetland and spring complex cut off from the upper reaches of Schnabel Creek by the driveway at station 263+60.

Upstream of the culvert the inlet stream flows from both directions along the toe of the road embankment. Flow is dispersed through a broad wetland area with little in the way of a defined channel. Based on observations and hand measurements, depth is usually less than 0.5' over a saturated organic base. Downstream of the culvert outlet is a 10' by 15' pool, with a depth of 3'. The pool leads into a 2' wide, 1' deep silt bottomed channel that meanders through willow and alder root systems. This channel winds roughly parallel to the road, swinging tight to the existing embankment toe between S&HI stations 260+50 and 261+00.

Station 245+19 (S&HI station 268+00). Tier 1 stream simulation

The existing pipe is a 36-inch CMP with a rusted bottom. Elevation is approximately 23-ft. Upstream and downstream conditions are described in the companion S&HI and summarized in the following paragraph. Fish passage is designed using Tier 1 stream simulation methods given good upstream habitats which include wetlands. Based on hand measurements of the existing stream, the representative channel is approximately 2-ft wide. In order to incorporate stream substrate material to Tier 1 standards and provide equal or greater conveyance to what exists, a 4-ft diameter CMP will be required.

As stated in the S&HI:

Catalog Number: 115-32-10250-2008

Stream Name: Waterfall Creek

Fish Use: Rearing coho, Chinook and Dolly Varden. Coho Spawning
Description: The ADFG catalog lists this pipe as the primary conduit of Waterfall Creek. This is no longer the case. The culvert at station S&HI station 275+66 now passes the majority of the flow that leads from the waterfall the creek is named for. Based on observations and hand measurements, upstream of the inlet there is a short, 2' wide, shallow stream segment leading into an emergent marsh. The stream substrate is organic matter over gravel. The outlet stream is a short, 2' wide, 0.7' deep section leading into the main stream that flows from the S&HI station 275+66 culvert. The stream banks are well vegetated with grasses.

Station 248+45 (S&HI station 271+40). Tier 1 stream simulation

The existing pipe is a 24-inch CMP with a rusted bottom. Elevation is approximately 22-ft. Upstream and downstream conditions are described in the companion S&HI and summarized in the following paragraph. Fish passage is designed using Tier 1 methods given excellent upstream habitats which include wetlands. Based on hand measurements of the existing stream the representative channel is approximately 3-ft wide. In order to incorporate stream substrate material to Tier 1 standards and provide equal or greater conveyance to what exists, a 3-ft diameter CMP will be required.

As stated in the S&HI:

Catalog Number: 115-32-10250-2008-3005

Stream Name: none listed, tributary to Waterfall Creek

Fish Use: Rearing coho, Dolly Varden, Chinook and cutthroat

Description: Upstream of the culvert the stream disperses immediately into thickly vegetated marsh in a broad remnant channel. Based on observations and hand measurements, there are a number of pools with depth of up to 3'. The pools are fed in part by a small mountain stream about 100' from the road. However, the majority of the flow comes from the stream and wetland complex that stretches ahead on line up to the waterfall near S&HI station 305+40. Downstream of the culvert the stream meanders along the road to S&HI station 273+00 before turning toward the river. The stream flows through a marsh in a defined channel, with the banks composed of thick vegetation. Substrate is organic; depth is 0.5 - 1'.

Station 292+90 (S&HI station 316+00). Tier 2 FISHPASS baffles

The existing crossing is two 24-inch CMPs with rusted bottoms. Elevation is approximately 26-ft. Upstream and downstream conditions are described in the companion S&HI and summarized in the following paragraph. Of note, upstream of the culverts is a gravel lined pool that was excavated following heavy sedimentation during the November 2005 flood. The pool is approximately 15-ft by 35-ft, and presently bare of vegetation. A few redds were observed during the October field investigations, prior to the November 2005 flood, thus fish have been seen to utilize upstream habitats and passage is to be provided. Fish passage was designed by Tier 2 FISHPASS methods given the poor quality of upstream habitats. The Tier 2 culvert was then analyzed for

conveyance capacity using HY-8 to exceed existing conditions. A 4-ft diameter CMP is required with baffles to a height of 0.6-ft.

As stated in the S&HI:

Fish Use: Rearing coho, cutthroat, Chinook and Dolly Varden. Spawning redds present

Description: Upstream of the culvert there is a large, shallow, gravel bottomed pool excavated after the November 2005 flood. Based on observations and hand measurements, this pool is fed primarily by a 4' wide cascade that passes through a culvert in the adjacent driveway. Another mountain stream near S&HI station 321+00 provides another 10% of the flow. All fish habitat above the culvert has been scoured to gravel. Redds were present in this section in October 2005. This stream is used for a small hydropower system. Downstream of the culvert is a 10' wide gravel bottomed plunge pool with redds present (October 2005) at the tailout. The stream then flows directly to the river in a 6-10' wide, rocky cascade channel, the lower end of which is influenced by the river backwater.

Station 314+72 (S&HI station 337+70). Tier 2 FISHPASS no baffles

The existing pipe is a 24-inch CMP with a rusted bottom. Elevation is approximately 28-ft. Upstream and downstream conditions are described in the companion S&HI and summarized in the following paragraph. Of note, upstream of the culverts is a gravel lined pool that was excavated following heavy sedimentation during the November 2005 flood. The pool is approximately 10- by 30-ft, and presently bare of vegetation. Some habitat value was noted during the October 2005 field investigations, prior to the November 2005 flood, thus fish passage is to be provided. Fish passage was designed by Tier 2 FISHPASS methods given the limited value of upstream habitats. The Tier 2 culvert was then analyzed for conveyance capacity using HY-8 to exceed existing conditions. A 3-ft diameter CMP is required to meet Tier 2 FISHPASS criteria.

As stated in the S&HI:

Fish Use: Rearing coho and Dolly Varden below culvert outlet

Description: Based on observations and hand measurements, upstream of the culvert there is a 10' by 30' pool created by ditch cleaning activity in the spring of 2006. This shallow pool is fed by a stream cascading down the cut slope adjacent to the pool. The inlet stream averages 4' wide and 0.1' deep and is well defined further upstream. Downstream of the culvert is an 8' diameter plunge pool 1.5' deep. The culvert was not perched in late May of 2006. The stream meanders the 140' to the Chilkat River through an 8' wide, high banked channel. The channel banks are thickly vegetated with alder and cottonwood. The stream meanders within this channel, with width varying from 1-3', and depth 0.2' to 0.8'. It is composed of pools and riffles over gravel.

Station 366+36 (S&HI station 389+25). Tier 1 stream simulation

The existing pipe is a 24-inch CMP with a rusted bottom. Elevation is approximately 30-ft. Upstream and downstream conditions are described in the companion S&HI and

summarized in the following paragraph. There is excellent juvenile rearing habitat upstream of the culvert. Therefore, fish passage was designed by Tier 1 stream simulation methods. Based on hand measurements in the S&HI and approximations from the project survey, channel width was assumed to be 4 feet wide. A 42 inch by 29 inch pipe arch was selected. Substrate will be placed in the culvert to 6-inch depth with slope set to accommodate adjacent stream slopes.

As stated in the S&HI:

Fish Use: Rearing coho, cutthroat and Dolly Varden

Description: Upstream of the culvert the 2-4' wide stream provides 40' of excellent rearing habitat for juvenile fish after it cascades down the hillside. Substrate is gravel and the cover is dense. Downstream of the culvert the stream runs through a channel incised in a river deposited sandbar and empties directly into the Chilkat River.

Station 382+07 (S&HI station 405+00). Tier 2 FISHPASS no baffles

The existing pipe is a 36-inch CMP with a rusted bottom. Elevation is approximately 30-ft. Upstream of the culvert is an extensive wetland that could provide excellent rearing habitat. The outlet of the existing culvert is perched, discharging directly to the Chilkat River. Periodic fish passage is enabled when the Chilkat River levels are sufficiently high to back water the culvert. The existing pipe meets Tier 2 FISHPASS fish passage requirements when the tailwater is 0.75-ft or greater over the outlet invert. Therefore, the culvert replacement can be of similar type and elevation as the existing culvert - hydraulic capacity would remain unchanged. The dynamic nature of the Chilkat River poses more risk to a constructed fish passage channel downstream of the culvert than is desirable. Therefore, the proposed culvert will have an outlet condition similar to existing; with periodic fish passage during Chilkat River high flow conditions backwatering the culvert.

As stated in the S&HI:

Catalog Number: 115-32-10250-2016

Stream Name: Lily Pad Creek

Fish Use: Rearing coho and Dolly Varden

Description: Based on observations and hand measurements, upstream of the culvert the first 50' of the stream consists of a 2' wide E type channel. The stream then disperses into a swamp and loses any defined channel. At the downstream end of the culvert the stream plunges directly onto a sandbar. There is an intermittent pool and shallow exit stream over the sandbar. Rearing fish access to the swamp is controlled by the river water level.

Station 419+95 (S&HI station 443+00). Tier 2 baffles

The existing pipe is two 24-inch CMPs with rusted bottoms. Elevation is approximately 39-ft. Upstream and downstream conditions are described in the companion S&HI and summarized in the following paragraph. Of note, upstream of the culverts is a gravel lined pool at the toe of a steep cascade. Fish passage was designed by Tier 2 FISHPASS

methods given the poor quality of upstream habitats. The Tier 2 culvert was then analyzed for conveyance capacity using HY-8 to exceed existing conditions. A 3.5-ft diameter CMP is required with baffles to a height of 0.6-ft.

As stated in the S&HI:

Fish Use: Rearing coho, cutthroat, steelhead and Dolly Varden. Possible spawning
Description: Based on observations and hand measurements, upstream of the culverts there is a 20' diameter gravel lined pool fed by a quickly steepening, 3-5' wide, rocky cascade/step pool section of stream. The culverts empty into a 6-8' diameter plunge pool. The active culvert is perched 4-6". The stream below the outlet pool is composed of riffles interspersed with step pools and is 3-6' wide. Substrate is small rocks and gravel. Mature vegetation overhangs the stream.

Station 530+70 (S&HI station 554+00). Tier 1 stream simulation

The existing pipe is a 24-inch CMP with a rusted bottom. Elevation is approximately 40-ft. Upstream of the culvert is 10-1/2 Mile Pond that could provide excellent rearing habitat. Fish passage is designed using Tier 1 stream simulation methods given excellent upstream habitats. Based on hand measurements of existing stream the representative channel is approximately 2-ft wide. In order to incorporate stream substrate material to Tier 1 standards and provide equal or greater conveyance to what exists, a 3-ft diameter CMP will be required.

As stated in the S&HI:

Catalog Number: 115-32-10250-2028-0010 (Pond is catalogued, stream not identified)

Stream Name: 10 1/2 Mile Pond, outlet stream

Fish Use: Coho and steelhead rearing

Description: Although this creek is not specifically shown on the ADF&G catalogue maps, it is directly connected to the 10 1/2 Mile Pond. Based on observations and hand measurements, upstream of the culvert is a 15' stream that then disperses into the pond. The stream is 2-3' wide and 0.3' deep. Stream substrate is organic, and vegetation grows throughout. Below the culvert outlet the stream runs for 6' in a 2' wide, 0.2' deep channel, then disperses into a 10-20' wide wetland full of grasses and willows. Flow in this wetland is visible, depth is 0.8 to 1.3'. There are some open water areas. This wetland continues along the road for about 175', then becomes more channelized (3' wide, 0.3' deep) and turns away from the road. Near station 551+00 the stream broadens to 8-10' wide. Many fish were noted to be present (June 2006).

Station 606+68 (S&HI station 630+00). Tier 2 FISHPASS no baffles

The existing pipe is a 24-inch CMP with a rusted bottom. Elevation is approximately 45-ft. The outlet of the existing culvert is perched, discharging directly to the Chilkat River. Periodic fish passage is enabled when the Chilkat River levels are sufficiently high to backwater the culvert. The existing pipe meets Tier 2 FISHPASS fish passage requirements when the tailwater is 0.6-ft or greater over the outlet invert. Therefore, the culvert replacement can be of similar type and elevation as the existing culvert -

hydraulic capacity would remain unchanged. The dynamic nature of the Chilkat River poses more risk to a constructed fish passage channel downstream of the culvert than is desirable. Therefore, the proposed culvert will have an outlet condition similar to existing; with periodic fish passage during Chilkat River high flow conditions backwatering the culvert.

As stated in the S&HI:

Fish Use: Rearing cutthroat and Dolly Varden

Description: The flood of November 2005 directed approximately two-thirds of the flow from the waterfall at S&HI station 629+50 towards this culvert. The rest of the flow exits through the culvert at S&HI station 612+50. Based on observations and hand measurements, above the culvert inlet the stream divides into a 6-8' wide, 1-2' riffle, pool, glide complex running through an established alder and birch forest. The stream substrate is silt and organics for the first 100', then changes to recently deposited alluvial material. The culvert empties directly into the Chilkat River and is perched at low water.

Station 736+83 (S&HI station 757+50). Either Tier 1 stream simulation or Tier 2 FISHPASS

The existing pipe is a 24-inch CMP with a rusted bottom. Elevation is approximately 57-ft. Upstream of the culvert is a pool and stream system that could provide excellent rearing habitat. The outlet of the existing culvert is perched, and discharges to a side channel of the Chilkat River with a surveyed width of about 8-ft wide – possibly a result of human disturbance. Based on preliminary methods either a 7'-4" by 5'-4" pipe arch for Tier 1 stream simulation design method or 3-ft diameter CMP for Tier 2 FISHPASS design method is likely to be required. This area is recommended for mitigation opportunities. The proposed replacement culvert will be integrated into a fish passage channel to connect the pipe to the Chilkat River for a greater range of flows.

As stated in the S&HI:

Fish Use: Rearing coho, Chinook and Dolly Varden

Description: Based on observations and hand measurements, upstream of the culvert there is a small waterfall fed pool that extends about 50' back on line. The stream branch leading to north is 5-8' wide and 0.3' deep for the first 35', where the main flow enters as a waterfall. This 35' riffle section is shallow, littered with organic debris, and has a gravel substrate. The water extends in a roadside ditch up to S&HI station 760+00 where there is another small waterfall. This reach is an 8' wide, 0.8' deep pool. Standing water with little flow extends another 100' ahead on line. Fish are present throughout. Downstream, the perched culvert empties into a silty channel backwatered by the river. Grass grows on the banks above the river level, but bare silt is exposed lower down. There is no cover. The river gravel bars near the outlet are actively used for spawning.

Station 767+14 (S&HI station 788+00). Tier 2 FISHPASS baffles

The existing pipe is one 36-inch CMP with a rusted bottom. Elevation is approximately 56-ft. Upstream and downstream conditions are described in the companion S&HI and summarized in the following paragraph. Of note, upstream of the culvert is a small stream that drains from the hill side. The outlet of the pipe is perched to a side channel of the Chilkat River. Given the poor quality of upstream habitats, the proposed culvert will have an outlet condition similar to existing; with periodic fish passage during Chilkat River high flow conditions backwatering the culvert. Fish passage was designed by Tier 2 FISHPASS methods for high river flow conditions given the poor quality of upstream habitats. The Tier 2 culvert was then analyzed for conveyance capacity using HY-8 to exceed existing conditions. A 3.5-ft diameter CMP is required with baffles to a height of 0.6-ft.

As stated in the S&HI:

Fish Use: Rearing coho, Chinook and Dolly Varden. Possible redd observed (October, 2005)

Description: The culvert is fed by two mountain streams that join together about 20' upstream of the inlet. One of the streams runs 100' back on line in a shallow, 2-3' wide, gravel bottomed roadside ditch which ends in a waterfall. The second branch runs for a distance of 120' away from the road and along the toe of the mountain before turning upslope as a waterfall. This 120' of stream is composed of 2-3' wide pool/riffle habitat with rock and gravel substrate. It is well vegetated. The culvert outlet empties directly into the river.

21.5 23 CFR

There is no known FEMA Flood Insurance Study for any of these existing culverts. The proposed action for each site includes replacement with a culvert that provides fish passage to either Tier 1 stream simulation or Tier 2 FISHPASS requirements and has flow capacity equal to or greater than the existing pipe. Risks of the proposed culverts are considered less than the existing structures. There is a reduction in upstream backwater effects and more efficient conveyance of flows through the pipes. There is less likelihood of sediment or debris blocking the culverts. The proposed culverts will improve stream process and provide more natural flood plain connectivity.

21.6 Conclusion

The hydraulic features of the proposed action are developed to a preliminary level at this phase in support of the Preliminary Engineering Report. Design will be completed for submittal with Plans-in-Hand. The proposed culverts were designed for fish passage using the Tier 1 stream simulation or Tier 2 FISHPASS method based on prior discussion and agreement with ADOT&PF and agency personnel. This provides favorable continuity of stream processes and passage of fish through the culvert from adjacent stream reaches. The proposed culverts will meet or exceed the conveyance of existing structures. The proposed culverts are not expected to impact the flood plain or environment.

The hydraulic summary for the proposed culvert are presented in Appendix 23.5.3.

21.7 Riprap

The culverts were designed using Tier 1 or Tier 2 stream simulation to maintain continuity of flow of water and sediment. Each culvert was designed to provide equal or greater flood capacity than currently exists. At this preliminary phase, the reduction in flow restriction is assumed to reduce any scour potential that may exist. Therefore, no riprap is proposed at this time.

22. References:

Alaska Department of Fish and Game and Alaska Department of Transportation and Public Facilities. 2001. *Memorandum of Agreement between the Alaska Department of Fish and Game and the Alaska Department of Transportation and Public Facilities for the Design Permitting and Construction of Culverts for Fish Passage.*

Alaska Department of Transportation and Public Facilities. 1995. *Alaska Highway Drainage Manual.*

Alaska Department of Transportation and Public Facilities. 2003. *Alaska Highway Preconstruction Manual.*

Arcement, G. J. and V. R. Schneider. 1989. Guide for Selecting Manning's Roughness Coefficients for Natural Channels and Flood Plains. U.S. Geological Survey Water-Supply Paper 2339.

American Iron and Steel Institute. 1983. Handbook of Steel Drainage & Highway Construction Products, third ed.

Bates, K. 2004. Fish-Friendly Culverts (short course notebook).

Behlke, C. et. al., 1991. FISHPASS culvert design software.

Behlke, C. et. al., 1991. Fundamentals of Culvert Design for Passage of Weak-Swimming Fish. FHWA-AK-RD-90-10.

Big R Manufacturing LLC. Corrugated Steel Pipe (brochure). www.bigrmfg.com

Curran, J.H., Meyer, D.F., Tasker, G.D., 2003, Estimating the Magnitude and Frequency of Peak Streamflows for Ungaged Sites on Streams in Alaska and Conterminous Basins in Canada: U.S. Geological Survey Water-Resources Investigations Report 03-4188

Federal Highways Administration (FHWA), 1989. HEC-11, Design of Riprap Revetment. FHWA-IP-89-016

FHWA, 1988. HEC-15, Design of Roadside Channels with Flexible Linings. FHWA-IP-87-7

FHWA, HY-8, Culvert analysis, version 6.1.

Hansen, Scott Borough of Haines email communication

Ingledue, Roger, personal communication, October 2005

Inter-Fluve, Inc. July 2006. Haines Highway MP 3.5-25.3, Stream and Habitat Inventory.

Inter-Fluve, Inc. 1999. Guidelines for Bank Stabilization on the Mendenhall River. ADF&G. Habitat Restoration Division, Technical Report 99-3.

Jones, S.H. and Fahl, C.B., 1994, Magnitude and frequency of floods in Alaska and conterminous basins of Canada: U.S. Geological Survey Water-Resources Investigations Report 93-4179.

Maynard, Stephen T., August 1996. "Toe-scour estimation in stabilized bendways". J of Hydraulic Engineering, pg 460-464

NOAA National Ocean Service, Center for Operational Oceanographic Products and Services (tidal data) <http://www.co-ops.nos.noaa.gov/benchmarks/9452421.html>

Post, Austin and Larry Mayo. 1971. "Glacier Dammed Lakes and Outburst Floods in Alaska". Department of the Interior United States Geological Survey Hydrologic Investigations Atlas HA-455.

Interagency Advisory Committee on Water Data (IACW). 1982. Guidelines for determining flood flow frequency: Bulletin 17B of the Hydrology Subcommittee. Office of Water Data Coordination. U.S. Geological Survey. Reston, Virginia, 183 p.

Natural Resources Conservation Service (NRCS). 1979. Digitized version of the Exploratory Soil Survey of Alaska; STATSGO Publication. U.S. Dept of Agriculture – NRCS. Fort Worth, TX.

Soil Conservation Service (SCS). 1984. Natural Resources Conservation Service (formerly the Soil Conservation Service) Engineering Field Handbook – Chapter 2: Estimating Runoff and Peak Discharges. US Dept of Agriculture – NRCS.

U.S. Army Corps of Engineer's HEC-RAS version 3.1.2, 2004

USGS gage data <http://nwis.waterdata.usgs.gov/ak/nwis/sw>

23. Appendices:

23.1 Culvert Inventory Table

Haines Highway - MP 3-25 Culvert Inventory

S&HI stationing
 Multiple pipes
 Big fish pipe
 Small fish pipe

as-built summary field

Notes: reference to 'emergent wetland' areas is used loosely by non-botanist and does not necessarily comply with strict wetland definition
 Stainline height above invert refers to low point of metal culvert; does not reference accumulations of material within pipe

Criteria used for determining if waters of the U.S.: drains stream, waterfall, or hillslope seeps; drains wetland or connected to wetland with evidence of flowing water; fish present.
 If notes indicate lack of channel (downstream or upstream), then did not consider a Water of the U.S.

count	As-built Station	Centerline stationing			QA'd	Culvert Size (in)	Culv Size	Culvert Length (ft)	As-Built Comment	Eng. Survey	Height to Stainline at:		fish bearing	Waters of the U.S.	Upstream conditions	Inlet Conditions	Outlet Conditions	Downstream conditions
		Design 9/2005	S&HI June/06	Design 10/2009							inlet(ft) ¹	outlet(ft) ¹						
Haines Highway MP 4 - 12.77 As-Built																		
1	212+58	212+50	212+53	189+51	dm	24	24	70			0.3			N	drains ditch; no water present	clear of debris/sediment at inlet; crimping of inlet from maintenance; gravel present in barrel 0.2 ft	opens to voids in large riprap	discharges to ditch
2	219+08	218+80	218+92	195+90	dm	24	24	74						N	drains ditch; no water present	partially obstructed by grass/debris; pipe invert filled 0.25-0.5 ft with gravel/sediment	could not locate; either hidden by riprap, sand dunes, or veg.	u/s of airport berm
3	235+52	234+90	235+12	212+10	dm	24	24	60			0.5	1		N	flowing water present discharge from u/s pipe to short open channel into road culvert	undamaged; slight sediment and veg obstruction	invert perched 0.8 ft abv channel ws; outlet damaged but open	discharges to Chilkat trib/slough. Mostly runoff or GW drainage.
4	237+51	236+87	237+09	214+07	dm	24	24	60			1			N		inlet and barrel clear of debris/sediment; bottom 0.2-0.3 ft rusted out	perched 0.45 ft abv scour pool ws	scour pool = 6 ft wide x 7 ft long x 1.4 ft depth. Trickle of water.
5	246+02	245+30	245+52	222+51	dm	48	48	SeeSurv.	Yes		1		Yes	Y	juvenile salmonids present	undamaged; clear of debris/sediment	slight damage; backwatered 50-66% of barrel	scour pool = 15 ft wide x 20 ft long x 1-1.5 ft depth; pool backfilled with fines; metal debris (55 gal drum and outlet apron) in outlet pool
6	252+55	251+75	251+96	228+95	dm	24	24	60			0.75			N	drains ditch @ SE Road Builders	undamaged; partially obstructed by grass	could not locate; likely covered by veg and backwater at wet meadow/wetland complex	discharges to wet meadow/wetland complex
7	263+93	263+20	263+40	240+38	dm	24	24	60			0.65			Y		undamaged; clear of debris/sediment; flowing water present	backwatered from wetland area	discharges to wet meadow/wetland complex
8	268+75	268+00	268+20	245+19	dm	36	36	60			0.65			Y		undamaged; some veg on streambed	no scour hole; outlet damaged, no perching	discharges to standing water in wetland area
9	272+00	271+25	271+45	248+45	dm	24	24	58			1.1		YES - S&HI	Y	drains wetland area (rushes)	undamaged	undamaged	discharges to standing water in wetland area; no scour pool; juvenile salmonids present
10	316+46	315+71	315+91	292+90	dm	24	24	50			0.7		YES - S&HI	Y	clean gravels <= 0.25 ft	inlet slightly crimped; flowing water present; drains stream (hydropower plant upstream)	outlet moderately crimped; backwatered 0.45 ft to stainline	flowing water
11	316+50	315+75	315+95	292+94	dm	24	24	50			0.7		YES - S&HI	Y	clean gravels <= 0.25 ft	inlet slightly crimped; flowing water present; drains stream (hydropower plant upstream)	outlet slightly crimped; backwatered 0.45 ft to stainline	flowing water
12	322+19	321+44	321+64	298+62	dm	24	24	56			0.4	0.6		Y	drains flowing water in ditch supplied from small cascades on adjacent hillslope	inlet slightly crimped	freefall discharge to Chilkat	discharges direct to Chilkat
13	323+54	322+80	32300	299+97	dm	24	24	56			0.5 (rust line 1 ft)			Y	drains flowing water in ditch supplied from hillslope seeps	undamaged; flowing water	silt in outlet from Chilkat backwater; discharges to Chilkat bank; perched	discharges direct to Chilkat
14	331+30	could not locate	could not locate		dm	24	24	56						N/A				
15	338+30	337+50	337+70	314+72		24		52			1.2	0.5			Drains stream and ditch. Cascade 12' from inlet.	culvert slightly crushed; flowing water present; bottom 0.5' filled with gravel	Slightly damaged but fully open	discharges into 10' by 10' pool, which connect to a 140' channel feeding into the Chilkat River
16	342+73	341+92	342+12	319+13		36	36	SeeSurv.	Yes	see survey data			Yes	Y	water present	undamaged; stainline may be from Chilkat backflow	damaged; stainline may be from Chilkat backflow	water present
17	348+30	could not locate	could not locate		48"?	24	24	48						N/A				
18	348+57	347+58	347+77	324+79	MB	48	48	SeeSurv.	Yes	see survey data			YES - S&HI	Y	drains stream	inlet crimped; backwatered	undamaged; backwatered	small channel backwatered by Chilkat
19	373+55	372+00	372+20	349+25	dm	24	24	56			1 (rust line)			N	rel. dry forested area; drains wet drainage ditch	inlet crushed and covered with grasses	undamaged; 0.5 ft of silt	drains to rocklined outfall
20	390+09	389+25	389+30	366+36	dm	24	24	56			0.5		YES - S&HI	Y	drains stream (4 ft wide x 1 ft depth x 30 ft to hillslope); flowing water	inlet slightly crimped	outlet slightly crimped	silt lined channel (3 to 6 ft wide x 1.5 ft depth)
21	392+69	391+75	391+91	368+94	dm	24	24				0.3 (rust line 0.5)		YES - S&HI	Y	drains pool below waterfall	inlet crimped; flowing water present; slight debris obstruction	undamaged	discharges through silt deposits along Chilkat
22	396+07	395+20	395+34	372+37	dm	24	24	56			0.6 (rust line)			n	drains damp meadow area	obstructed by silt and veg; slightly crimped	freefall discharge to Chilkat; full of silt	
23	405+81	404+90	405+04	382+07	dm	36	36	56	No				YES - S&HI	Y				
24	427+27	426+30	426+52	403+57	dm	24	24	64			0.1	0.1		N	small dry forested hillslope	damaged; dry	damaged; clear of silt; discharges to steep grass bank at Chilkat	discharges direct to Chilkat bank

Haines Highway - MP 3-25 Culvert Inventory

S&HI stationing
 Multiple pipes
 Big fish pipe
 Small fish pipe

as-built summary field

Notes: reference to 'emergent wetland' areas is used loosely by non-botanist and does not necessarily comply with strict wetland definition
 Stainline height above invert refers to low point of metal culvert; does not reference accumulations of material within pipe

Criteria used for determining if waters of the U.S.: drains stream, waterfall, or hillslope seeps; drains wetland or connected to wetland with evidence of flowing water; fish present.
 If notes indicate lack of channel (downstream or upstream), then did not consider a Water of the U.S.

count	As-built Station	Centerline stationing			QA'd	Culvert Size (in)	Culv Size	Culvert Length (ft)	As-Built Comment	Eng. Survey	Height to Stainline at:		fish bearing	Waters of the U.S.	Upstream conditions	Inlet Conditions	Outlet Conditions	Downstream conditions
		Design 9/2005	S&HI June/06	Design 10/2009							inlet(ft) ¹	outlet(ft) ¹						
25	431+39	430+40	430+60	407+65	dm	24	24	58			no stainline/no rust line	no stainline/no rust line		N	dry ditch at hillslope toe	slightly bent; clear; dry	crimped at top; freefall 0.5 ft to Chilkat bank	discharges direct to Chilkat bank
26	434+51	433+50	433+70	410+72	dm	24	24				0.3 (rust line)	0.3 (rust line)		N	ditchline maintained to drain 'dry' grassy area	crimped; phone line cable exposed at inlet	freefall discharge to Chilkat bank; silt extends 5 ft into pipe to meet rustline elev	discharges direct to Chilkat bank
27	443+80	442+72	442+98	419+95	dm	24	24				0.5 (rust line)		YES - S&HI	Y	steep boulder cascade stream	torn, crimped, and crushed; inlet located at 15 ft diam pool below steep boulder cascade; flowing water	perched 0.5 ft; scour pool = 8 ft long x 12 ft wide x 1.5-2 ft depth	cobble / small boulder stream
28	443+84	442+76	443+02	419+99	dm	24	24				0.6 (rust line)		YES - S&HI	Y	steep boulder cascade stream	torn, crimped, and crushed; inlet located at 15 ft diam pool below steep boulder cascade; flowing water	perched 0.5 ft; scour pool = 8 ft long x 12 ft wide x 1.5-2 ft depth	cobble / small boulder stream
29	457+01	456+00	456+23	433+00	dm	24	24				0.4 (rust line)	0.4		Y	drains damp ditchline immediately below steep cascade (4 x 1 ft seep)	1 ft diam rock at inlet (slight obstruction); inlet slightly crimped	slight silt/organics obstruction	shallow channel approx 10 ft to top of Chilkat bank; no siltation
30	473+16	471+80	472+09	449+03	dm	24	24	58				0.1		N	drains rocky hillslope below switchback driveway; dry	torn and crushed	clear; discharges to riprappd Chilkat bank	discharges direct to Chilkat bank
31	477+44	476+10	476+41	453+34	dm	24	24	62				0.2		Y	drains small waterfall 50 ft up ditch; hillslope mostly dry	moderately crushed; flowing water	3 ft freefall to Chilkat riprap bank; pipe outlet located at Chilkat bank veg line	discharges direct to Chilkat bank
32	486+74	485+35	485+73	462+55	dm	24	24	52			1.2	0.3 (rust line)		Y	drains small waterfalls	0.3 ft sediment in inlet	1 ft freefall to Chilkat bank	discharges direct to Chilkat bank
33	493+85	491+50	491+90	468+70	dm	24	24	60			no stainline (rust line = 0.7 ft)	0.8 (rust line)		N	drains damp forested area	undamaged; no water present	pipe outlet located at Chilkat bank veg line	discharges to Chilkat sandbar at wood debris elev. Drainage pipe; no defined channel upstream; discharge dumps onto gravel bar.
34	497+63	502+00	502+38	479+18	dm	24	24	60						N		obstructed by veg and organic debris; no water present	undamaged; 0.8 ft blocked by debris	
35	507+36	506+00	506+37	483+18	dm	48	48	SeeSurv.	Yes	see survey data	see survey data	YES - S&HI	Y	drains stream that drains wetland complex; juvenile salmonids observed	sheet flow at inlet apron (fish passage barrier); debris blocking passage inside pipe	drains into large outlet pool; undamaged; clear of debris	juvenile salmonids observed; imperceptible flow; no surface connection with Chilkat at d/s end	
36	536+86	535+08	535+49	512+24	dm	24	24	SeeSurv.	Yes	see survey data	see survey data	Yes	Y	flowing stream; redds located just upstream of inlet; juvenile salmonids and a dolly varden adult observed	undamaged	undamaged	many pink carcasses; drains into flowing stream with good spawning gravels; long slough to Chilkat confluence	
37	536+91	535+15	535+56	512+32	dm	36	36	SeeSurv.	Yes	see survey data	see survey data	Yes	Y	flowing stream; redds located just upstream of inlet; juvenile salmonids and a dolly varden adult observed	undamaged	undamaged	many pink carcasses; drains into flowing stream with good spawning gravels; long slough to Chilkat confluence	
38	542+31	540+60	541+00	517+67	dm	24	24	60				0.4 & 1		Y	drains emergent wetland	inlet base rusted out; veg obstructing inlet	backwatered by Chilkat	discharges to wetland area; perched
39	548+88	547+00	547+50	524+10	dm	24	24	60						Y	drains flat emergent wetland/wet meadow area	0.5 ft obstructed by silt and organics	obstructed by veg; 0.5 ft open pipe; 1.5 ft obstructed by silt/organics	no defined channel
40	555+36	553+60	554+06	530+70	dm	24	24	60			0.5 (rust line)			Y		torn; obstructed by silt and emergent veg; trickle of flowing water present	0.9 ft silt/organics; encroaching veg	discharges to emergent wetland
41	564+41	562+70	563+14	539+77	dm	24	24				0.3			N	drains roadside ditch/ gen'l dry forested area	slightly torn; clear of debris	unraveled 0.5 ft; gravel deposition in outlet	drains to wet roadside ditch
42	571+31	569+60	570+02	546+65	dm	24	24	58				0.8 (rust line)		N	drains mostly dry forested area	obstructed by alders, grass, sediment	d/s berm approx. 0.8 ft causing rust line @ 0.8 ft	drains to flat wet meadow/emergent area
43	581+53	579+75	580+25	556+84	dm	24	24	56			no stainline	no stainline		N	drains dry hillslope and roadside ditch	water stains in base of corrugations	slight berm at outlet; no stainline	grasses laid flat
44	593+79	591+98	592+40	569+06	dm	24	24	60			rustline 0.4-ft WIDE (convert to H)	1 (backwatered by river?)		N	drains dry forested area	rust line 0.4 ft wide; 0.3 ft obstructed by organic debris	backwatered by Chilkat (?)	drains to standing water
45	596+62	594+80	595+25	571+88	dm	24	24	60			0.2	0.7 (rust line)		N	drains dry hillslope and roadside ditch	slightly crimped; invert above upstream sump	0.3 ft organic matter	drains to roadside ditch/emergent wetland
46	601+08	599+30	599+72	576+36	dm	24	24	54			0.4 (rust line)	1 (rust line)		Y	drains dry hillslope and small emergent wetland area		berm of organics 0.7 ft	drains to pond/emergent wetland
47	604+50	602+70	603+14	579+78	dm	24	24	60			1	1.5 (rust line)		Y	drains emergent wetland	undamaged; water level 0.2 ft	undamaged	drains to pond/emergent wetland; channel = 1.5 ft wide x 0.5 ft depth; water 0.5 ft deep

Haines Highway - MP 3-25 Culvert Inventory

S&HI stationing
 Multiple pipes
 Big fish pipe
 Small fish pipe

as-built summary field

Notes: reference to 'emergent wetland' areas is used loosely by non-botanist and does not necessarily comply with strict wetland definition
 Stainline height above invert refers to low point of metal culvert; does not reference accumulations of material within pipe

Criteria used for determining if waters of the U.S.: drains stream, waterfall, or hillslope seeps; drains wetland or connected to wetland with evidence of flowing water; fish present.
 If notes indicate lack of channel (downstream or upstream), then did not consider a Water of the U.S.

count	As-built Station	Centerline stationing			QA'd	Culvert Size (in)	Culv Size	Culvert Length (ft)	As-Built Comment	Eng. Survey	Height to Stainline at:		fish bearing	Waters of the U.S.	Upstream conditions	Inlet Conditions	Outlet Conditions	Downstream conditions
		Design 9/2005	S&HI June/06	Design 10/2009							inlet(ft) ¹	outlet(ft) ¹						
48	613+80	612+10	612+47	589+12	mb	24	24	SeeSurv.	Yes	entire pipe stained	entire pipe stained	Yes	Y	juvenile salmonids observed	perched above inlet pool	perched	dominated by glacial silt from Chilkat	
49	613+85	612+20	612+57	589+22	mb	24	24	SeeSurv.	Yes	entire pipe stained	entire pipe stained	Yes	Y	juvenile salmonids observed	undamaged; see survey for additional info	1.5 ft cascade to ws of outlet pool	dominated by glacial silt from Chilkat	
50	621+37	619+30	619+53	596+17	dm	24	24	58		0.7	0.3		Y	drains emergent wetland	0.3 ft veg/silt	undamaged; 0.1 ft organics	drains to emergent wetland	
51	631+88	629+81	630+04	606+68	dm	24	24	64		1.1	1		Y	drains stream = 6 ft wide x 1 ft depth with lots of small woody debris	sides bent inward (vertical orientation); flowing water present	perched 1 ft above toe of stream bank; middle of outlet located at Chilkat bank veg line	discharges direct to Chilkat bank	
52	651+18	648+25	648+47	625+12	dm	24	24	60		1.2 (backwater?)			Y	drains emergent wetland	obstructed by organics	0.8 ft berm of organics; discharges to sump; surrounding ground is above pipe crown	no outlet channel	
53	667+57	665+50	665+42	642+37	dm	24	24	66		0.7			Y	drains small stream (dry) from ephemeral swamp area; channel 2 ft wide x 0.75 ft deep	inlet crimped	fully rusted; 1.5 ft freefall to channel bottom; scour pool (wet) = 10 ft wide x 5 ft long (recessed)	discharges direct to Chilkat side-channel	
54	672+37	670+32	670+25	647+16	mb	36	36	SeeSurv.	Yes			YES - S&HI	Y		perched		Fairly active flow - see SH&I	
55	672+47	670+41	670+34	647+26	mb	36	36	SeeSurv.	Yes	see survey data	see survey data	YES - S&HI	Y	stream (see survey data)	see survey data	entire pipe stained	stream (see survey data)	
Haines Highway MP 12.5 - 25.3 As-Built																		
56	680+80	678+45	677+70	655+35	dm	24	24	52			0.2 ft moss line		N	drains sump from low depression/swale	crimped; moss line 0.2 ft	0.2 ft organics in outlet	no d/s channel	
57	690+50	688+30	686+09	665+04	dm	24	24	54					N		slightly crimped; crown is below surrounding grade; 3 ft diam sump down to pipe inlet; 0.4 ft material in inlet	buried by silt to 0.75 ft above crown (by Chilkat river); 1 ft diam exit hole.	discharges direct to Chilkat bank	
58	695+20	694+00	691+46	670+70	mb	24	24	66					N	drains meadow area	90% plugged; dry	100% plugged; non-functional	discharges direct to Chilkat bank	
59				681+50		18	18	unknown						Drains ditch	intact and dry; filled with 0.5' organics	Not found	would discharge directly into river	
60	711+18	709+00	706+48	685+71	mb	24	24	54					N	drains road ditch	clear of debris; no stainline; no water present	80% plugged; 1.2 ft silt in outlet	discharges direct to Chilkat bank	
61	718+78	718+00	715+44	694+68	mb	24	24	58					N	drains road ditch at hillslope base	clear of debris; no stainline; no water present	damaged from riprap; 100% plugged with silt; located at Chilkat bank	discharges direct to Chilkat bank	
62	729+50	727+30	724+80	704+04	mb	24	24	56					N	drains road ditch at hillslope base	clear of debris; no stainline; no water present	outlet filled with 1.6 ft sand from Chilkat backflow	discharges direct to Chilkat bank	
63	733+96	731+70	729+25	708+49	mb	24	24	60		0.9			N		clear of debris but debris encroaching; no water present	stainline covers entire pipe (backwater effect); filled with 1 ft sediment (sand and gravels); no water present	discharges into road ditch that connects with outlet pool of 734 culvert. Fairly dry; road maint.	
64	735+80	733+60	731+46	710+70	mb	36	36	See surv.	Yes	entire inlet stained (backwater effect)	entire inlet stained (backwater effect)	YES - S&HI	Y	drains stream	clear of debris; see survey data	clear of debris; see survey data	discharges to backwater slough of Chilkat	
65	735+86	733+68	731+52	710+76	mb	36	36	See surv.	Yes	entire inlet stained (backwater effect)	entire inlet stained (backwater effect)	YES - S&HI	Y	drains stream	clear of debris; see survey data	clear of debris; see survey data	discharges to backwater slough of Chilkat	
66	26+30	755+08	752+69	731+92	mb	24	24	72					N	drains road ditch/swale	filled with organics 0.5 ft	could not locate; buried with Chilkat sediment	if not buried would discharge direct to Chilkat bank	
67	31+07	759+97	757+62	736+83	mb	24	24	60		0.7	0.6	YES - S&HI	Y	drains ditch fed by hillslope waterfall	clear of debris; flowing water; avg chan width = 7 ft	clear of debris; freefall 0.7 ft to outlet pool ws	outlet pool depth 0.7 ft; avg chan width 4 ft; channel incised through silt prior to entering Chilkat	
68	34+12	763+00	760+70	739+85	mb	24	24	72		0.7	0.7		y	drains ditch at base of hillslope	filled with 0.1 ft sediment; flowing water present	clear of debris	discharges direct to Chilkat side channel bank	
69	35+88	764+72	762+46	741+64	mb	24	24	64		0.7	1.2		Y	drains road ditch fed by hillslope seeps/falls	filled with sediment 0.1 ft	filled with sediment 0.4 ft; 15% plugged	discharges direct to Chilkat bank	
70	36+92	765+80	763+55	742+72	mb	24	24	62					Y	hillslope waterfall nearly at inlet; 1.5 ft riffle (cobble) to river level	filled with sediment 0.8 ft; culvert half filled with water; inlet pool = 3 ft wide x 3 ft long x 0.3 depth	filled with sediment 0.7 ft	discharges direct to Chilkat bank	

Haines Highway - MP 3-25 Culvert Inventory

S&HI stationing
 Multiple pipes
 Big fish pipe
 Small fish pipe
 as-built summary field

Notes: reference to 'emergent wetland' areas is used loosely by non-botanist and does not necessarily comply with strict wetland definition
 Stainline height above invert refers to low point of metal culvert; does not reference accumulations of material within pipe

Criteria used for determining if waters of the U.S.: drains stream, waterfall, or hillslope seeps; drains wetland or connected to wetland with evidence of flowing water; fish present.
 If notes indicate lack of channel (downstream or upstream), then did not consider a Water of the U.S.

count	As-built Station	Centerline stationing			QA'd	Culvert Size (in)	Culv Size	Culvert Length (ft)	As-Built Comment	Eng. Survey	Height to Stainline at:		fish bearing	Waters of the U.S.	Upstream conditions	Inlet Conditions	Outlet Conditions	Downstream conditions
		Design 9/2005	S&HI June/06	Design 10/2009							inlet(ft) ¹	outlet(ft) ¹						
71	39+79	768+60	766+33	745+50	mb	24	24	58			0.8			Y	upstream channel = 5 ft wide x 0.3 ft depth	clear of debris; flowing water present	clear of debris; 1/3 field with Chilkat backwater; no obvious stainline	discharges direct to Chilkat bank
72	48+50	778+40	776+04	755+29	mb	24	24	62						N		clear of debris; no stainline; no water present	does not reach river; plugged with silt	30 ft of river bank between outlet and Chilkat. Appears to be a cross drainage ditch; really no defined channel.
73	61+38	790+28	788+00	767+14	mb	36	36	52			1	1.4	YES - S&HI	Y	upstream channel fed by hillslope waterfall; upstream channel 4.5 ft avg width	filled with sediment 0.3 ft; flowing water present	filled with sediment (Chilkat silt) 0.2 ft	discharges direct to Chilkat bank
74	65+16	793+88	791+60	770+74	mb	24	24	52						Y	drains wall-based slough/wetland	clear of debris; stain covers entire pipe (backwater effects); 1/2 full of water	clear of debris; 1/3 full of standing water; water depth in pipe 1 ft; stainline covers entire outlet (backwater effects)	outlet pool = 4.5 ft wide x 25 ft long x 1.2 ft depth; juvenile salmonids present
75	83+28	811+97	809+68	788+83	mb	24	24	50						N	drains roadside ditch at base of hillslope	filled with sediment 0.3 ft; 15% plugged; no water present	90% buried with Chilkat silt	6 ft of river bank between outlet and Chilkat braid
76	89+55	818+00	815+70	794+86	mb	24	24	50						Y	drains south end of wetland complex	filled with organic sediment 0.6 ft; 80% plugged	could not locate; buried or under water	discharges into large wetland complex
77	94+00	823+00	820+80	800+00	mb	24	24	52						Y	standing water; drains wetland area	filled with sediment 0.5 ft; only 1.5 ft width open	could not locate; buried	discharges into large wetland complex
78	119+15	847+77	845+54	824+68	mb	24	24	50						N	drains roadside ditch/swale at hillslope base	filled with sediment 0.6 ft; inlet top bent; 10% plugged; no water present	filled with sediment 0.4 ft; 15% plugged	no well-defined channel
79	130+05	858+55	856+36	835+52	mb	24	24	52						N		filled with sediment 0.2 ft; open width 1.8 ft; 25% plugged with organics; no water present	filled with sediment 0.7 ft; 20% plugged; no water present	
80	136+02	864+51	862+33	841+48	mb	24	24	52						N		filled with sediment 0.4 ft; 1.5 ft width open; 25% plugged; no water present	filled with sediment 0.2 ft; 10% plugged; no water present	
81	138+70	867+10	864+92	844+10	mb	24	24	64			0.1			N	drains road ditch	clear of debris/sediment; no water present	filled with sand 1 ft; 50% plugged	
82	152+23	880+00	877+89	857+45	mb	36	36	98			1.7	2.5 (backwater effects)		Y	stagnate pool at inlet 15 ft x 15 ft x 1 ft depth	filled with organic sediment 0.4 ft; backwatered; standing water present	small amount of flowing water;	60 ft from outlet to Chilkat braid. Silty muck
83	160+50	888+25	886+29	865+88	mb	6'-1"x4'-7"	6'-1"x4'-7"	See surv.		Yes	see survey data	see survey data	Yes	Y	drains roadside ditch (2-15 ft width) created by excavation for road fill; ditch filled with 2 ft organic silt; ditch supplied by high gradient stream (egg boxes)	good condition; see survey data	clear of sediment; small drop to outlet pool water surface; see survey data	short distance to Chilkat braid (<50 ft); adult chum present; redds observed at outlet
84	168+10	895+91	894+36	873+49	mb	24	24	68						Y	u/s bfw = 12 ft; backwatered; water present but no discernable flow; connects with 887+70 ditch	filled with 0.8 ft sediment; 1 ft width open; barely functional	filled with sediment 1.4 ft	small stagnate pool near outlet 3 ft x 3 ft; dead and dying juvenile coho present
85	187+25	915+15	911+92	890+91	mb	24	24	56			0.4	0.2		Y		clear of debris/sediment; flowing water draining ditchline	0.6 ft freefall to cobble riffle; 3.5 ft long riffle to pool; pool 0.8 ft depth; fish passage barrier at this flow	20 ft to confluence with Chilkat tributary
86	193+85	921+16	916+81	887+60	mb	36	36 (2)	See surv.	Stream realignment	Yes	see survey data	see survey data	Yes	Y	stream appears near bankfull	2 36 inch culverts; water level near stainline; appears to be spring fed system	gradient steepens above inlet pool; see survey data	E channel; see survey data
87		921+21	916+81	887+60	mb	36		see surv.		Yes			YES - S&HI	Y		One of two see above		
88	199+90	927+54	921+66	900+76	dm	24	24	60			none			N	drains roadside ditch	inlet slightly crimped; no stainline	undamaged; scour hole = 3 ft long x 3.5 ft wide x 0.7 ft depth	falls away steeply; filled with organic debris (leaves)
89	207+36	933+10	927+22	906+00	dm	24	24	62			none			N	drains roadside ditch	80% crimped; no stainline	15-20% plugged with organics; no scour pool	no d/s channel; slight swale
90	223+41	949+02	943+08	921+91	dm	24	24	52			none			N	drains roadside ditch	slightly crimped; no stainline; slight gravel build-up	slightly crimped; no scour pool	no discernable channel
91	239+38	965+08	959+14	937+97	dm	24	24	68			none			N	drains roadside ditch	inlet torn and crimped; no stainline; clear of debris/sediment	could not locate; buried by leaves, wood, or gravel	no discernable channel
92		973+53	967+58	946+42		18	18				none				drains roadside ditch, no flow	filled 0.7' with sand/organics, in good condition	outlet is buried by road widening fill material	
93	263+52	989+18	983+24	962+06	mb	8'-2"x5'-9"	8'-2"x5'-9"	see surv.		Yes	see survey data	see survey data	YES - S&HI	Y	debris flow; stream flowing in from south (re-routed to prevent frequent culvert plugging)	silt and cobble base (debris flow material); see survey data	see survey data	debris flow path
94	270+68	could not locate	could not locate			8'-2"x5'-9"		60						N/A				

Haines Highway - MP 3-25 Culvert Inventory

S&HI stationing
 Multiple pipes
 Big fish pipe
 Small fish pipe

as-built summary field

Notes: reference to 'emergent wetland' areas is used loosely by non-botanist and does not necessarily comply with strict wetland definition
 Stainline height above invert refers to low point of metal culvert; does not reference accumulations of material within pipe

Criteria used for determining if waters of the U.S.: drains stream, waterfall, or hillslope seeps; drains wetland or connected to wetland with evidence of flowing water; fish present.
 If notes indicate lack of channel (downstream or upstream), then did not consider a Water of the U.S.

count	As-built Station	Centerline stationing			QA'd	Culvert Size (in)	Culv Size Length (ft)	Culvert Length (ft)	As-Built Comment	Eng. Survey	Height to Stainline at:		fish bearing	Waters of the U.S.	Upstream conditions	Inlet Conditions	Outlet Conditions	Downstream conditions
		Design 9/2005	S&HI June/06	Design 10/2009							inlet(ft) ¹	outlet(ft) ¹						
95	274+68	1000+33	994+50	973+30	mb	9'-9"x6'-9"	9'-9"x6'-9"	see surv.		Yes	see survey data	see survey data	Unknown - S&HI	Y	debris flow; stream flowing in from north (re-routed to prevent frequent culvert plugging); main slide path to south	silt and cobble/boulder base (debris flow material; see survey data)	see survey data	debris flow path
96	277+96	1003+55	997+82	976+60	dm	36	36	52			0.4			Y	drains north end of 21 mile fan and ditch	inlet slightly torn and crimped; slight gravel accumulation	slight obstruction by sapling; filled with sand 0.3 ft	discharges to road side drainate channel with cobble substrate
97	299+51	1025+15	1019+52	998+31	dm	24	24	48						n		80% filled with gravel from upstream headcut	d/s channel aggraded to above pipe crown; pressure flow has maintained a 1 x 2 ft opening	
98	309+20	1034+85	1029+22	1008+00	dm	36	36	54			0.5			Y	along relic debris flow channel; 50 x 75 ft excavated (trap) area at base of debris flow path	slightly crimped; nearly plugged by sediment	filled with sediment to 0.2 ft	discharges to Chilkat along 15 ft channel (filled with salmon bones)
99	321+76	1047+37	1041+78	1020+52	dm	24	24	60						N	possibly a relic debris flow path	obstructed by wood waste; area above possibly relic debris flow path	d/s channel aggraded to pipe crown; scour has kept outlet clear	no defined channel; 30 ft to Chilkat
100	339+68	1065+33	1059+68	1038+52	dm	24	24	60			0.6			Y	drains small waterfall area; active flow	Recent pipe; obstructed by veg and sediment	free discharge to Chilkat riprap bank	discharges direct to Chilkat bank
101	343+46	1069+11	1063+49	1042+32	dm	24	24	62			0.7			N	drains roadside ditch; wet but no flow	filled with debris 0.4 ft; slightly crimped; sump at inlet; excavated ditchline above crown	free discharge to Chilkat riprap bank	discharges direct to Chilkat bank
102	346+00	1071+64	1066+02	1044+85	dm	24	24	54			0.85	0.2		Y	adjacent ditch is wet seep; flowing water present	filled with gravel 0.5 ft; flowing water present	clear of debris; perched 0.1-0.2 ft; discharges to moderately steep channel to Chilkat; no Chilkat silt dep.	mod steep channel section to Chilkat
103	348+24	1073+85	1068+21	1047+05	dm	24	24	54				0.7		Y		filled with debris 1 ft; slightly crimped	filled with sediment 0.6 ft	short channel to top of Chilkat bank above siltation. Flowing water; a number of seeps.
104	350+43	1075+92	1070+30	1049+14	dm	24	24	62			0.6	0.2		Y		some gravel accumulation; flowing water present	clear of debris, has end section	mod steep channel to top of Chilkat bank; no siltation. Flowing water; a number of seeps.
105	352+50	1077+95	1072+31	1051+16	dm	24	24	56			1.1 stainline (0.3 rust line)			Y		rust line 0.3 ft; flowing water present; slight sediment accumulation	outlet apron direct to Chilkat bank	discharges direct to Chilkat bank approx 5 ft above veg line. Flowing water; a number of seeps. GW coming out of hillside.
106	355+09	1080+50	1074+92	1053+75	dm	24	24	64			0.5 (rust line)			Y	small waterfall u/s of inlet	inlet crimped; flowing water present	discharges to Chilkat riprap bank	discharges direct to Chilkat bank
107	360+08	1085+00	1079+88	1058+72	dm	24	24	52		could not locate				y				
108	372+75	1098+16	1092+52	1071+35	dm	24	24	50			0.8	0.9	no access - S&HI	Y		filled with gravel 0.25 ft; water depth 0.3 ft above gravel	no outlet apron	steep channel. Active water flow.
109	380+94	1106+38	1100+68	1079+57	dm	24	24	56			0.2			Y	small waterfall direct to inlet	slightly crimped; filled with gravel 0.1-0.2 ft	1/2 filled with gravel and rock	discharges to waterfall to Chilkat River
110	383+11	1108+56	1102+85	1081+75	dm	24	24	54			0.3			Y	active flow from seeps	undamaged and clear of debris; flowing water present	obstructed by organics - no adequate flushing flow	discharges to steep cascade (1:1) to Chilkat
111	397+60	1123+05	1117+35	1096+25	dm	24	24	54			0.2			Y	drains waterfall/seeps along debris flow path	obstructed by rocks and veg to 1.6 ft; undamaged	undamaged; clear of debris	discharges to steep bank waterfall 1.8 ft to gully
112	403+58	1129+00	1123+25	1102+19		36	36	see surv.		Yes	see survey data	see survey data	YES - S&HI	Y	small stream; very little flow	good condition; see survey data	good condition; see survey data	small channel; area has been heavily altered
113	403+62					36	36	66						Y				paired with 1129 culvert
114	418+59	could not locate	could not locate			36	36	64						N/A				
115	420+79	could not locate	could not locate			36	36	60						N/A				
116	454+17	could not locate	could not locate			24	24	56						N/A				
117	466+88	1192+33	1186+58	1165+44	dm	24	24	62			none	none		N	drains roadside ditch (dry)	good condition; no stainline	moss in bottom 0.3 ft; no stainline	no defined d/s channel
118	472+18	1197+66	1191+92	1170+78	dm	24	24	64						N	drains ditch (dry)	crimped; 50% obstructed; inlet perched 0.5 ft above ditch	some organics in bottom; good condition; possibly a recent extension; no stainline	
119	476+64	could not locate	could not locate			24	24	60						N/A				
120	480+47	1206+60	1200+73	1179+75		About 13'	About 13'	see surv.		Yes	see survey data	see survey data	Unknown - S&HI	Y	large debris flow path; stream and debris flow path to north of inlet; excavated sediment trap at base of debris path; see survey data	concrete base; flowing water present; sheet flow over inlet apron; approx half of width with silt/cobble debris flow material; machinery able to drive through to clear culvert; see survey data	concrete base; approx half of width with silt/cobble debris flow material	debris path; see survey data

Haines Highway - MP 3-25 Culvert Inventory

S&HI stationing
 Multiple pipes
 Big fish pipe
 Small fish pipe

as-built summary field

Notes: reference to 'emergent wetland' areas is used loosely by non-botanist and does not necessarily comply with strict wetland definition
 Stainline height above invert refers to low point of metal culvert; does not reference accumulations of material within pipe

Criteria used for determining if waters of the U.S.: drains stream, waterfall, or hillslope seeps; drains wetland or connected to wetland with evidence of flowing water; fish present.
 If notes indicate lack of channel (downstream or upstream), then did not consider a Water of the U.S.

count	As-built Station	Centerline stationing			QA'd	Culvert Size (in)	Culv Size	Culvert Length (ft)	As-Built Comment	Eng. Survey	Height to Stainline at:		fish bearing	Waters of the U.S.	Upstream conditions	Inlet Conditions	Outlet Conditions	Downstream conditions
		Design 9/2005	S&HI June/06	Design 10/2009							inlet(ft) ¹	outlet(ft) ¹						
121	488+60	1214+20	1208+26	1187+25		8'-2"x5'-9"	8'-2"x5'-9"	see surv.		Yes	see survey data	see survey data	Unknown - S&HI	Y	large sediment trap excavated u/s of inlet; large headcut at base of debris flow path; see survey data	partially obstructed with fill material from maintenance; no water present	perched; no water present; see survey data	debris path; see survey data
122	511+95	could not locate	could not locate			24		56						N/A				
123	536+93	not surveyed	not surveyed			24	24	54						N				floodplain relief only
124	537+89	1263+00	1259+44	1238+45	dm	24	24	58			none			N	no slope; north end slightly crimped; no stainline; pipe likely to equalize floodplain flood waters on either side of road embankment			

23.2 Hydrology - Table of flow estimates for tributary basins.

Flow estimates include those obtained by: 1) USGS regional regression equations, 2) SCS Unit Hydrograph Method, and 3) the Rational Method. The estimates from the USGS regional regression estimates are the recommended flow estimates for flood conveyance and fish passage design assessments.

Return Period	Culvert Station										
	222+51 (0.47mi ²)	319+13 (0.6 mi ²)	324+79 (1.23mi ²)	483+18 (1.07 mi ²)	512+24 (1.46 mi ²)	589+12 (0.65 mi ²)	647+20 (1.75 mi ²)	710+75 92.26 mi ²)	865+88 (0.8 mi ²)	887+60 (1.55 mi ²)	1102+19 (1.26 mi ²)
2-Year											
Regional Regression	42	50	92	76	73	52	96	125	55	95	73
SCS Unit Hydrograph Method	119	141	304	333	397	196	471	637	294	558	496
Rational Method	37	48	98	86	117	52	140	181	64	124	101
5-Year											
Regional Regression	64	75	137	113	107	78	142	186	82	141	109
SCS Unit Hydrograph Method	250	295	628	603	714	358	851	1,137	451	857	693
Rational Method	47	60	124	108	147	66	177	228	81	156	127
10-Year											
Regional Regression	79	93	169	139	130	96	174	228	101	175	135
SCS Unit Hydrograph Method	274	323	689	670	793	398	946	1,263	531	1,009	817
Rational Method	56	71	147	129	175	78	210	272	96	186	152
25-Year											
Regional Regression	99	117	212	175	166	121	220	288	127	219	170
SCS Unit Hydrograph Method	357	422	898	905	1,070	537	1,276	1,704	677	1,286	1,041
Rational Method	64	82	169	147	201	90	241	312	110	213	174
50-Year											
Regional Regression	114	135	246	203	193	140	255	334	148	255	198
SCS Unit Hydrograph Method	429	507	1,079	1,003	1,187	596	1,416	1,890	760	1,445	1,169
Rational Method	69	88	180	158	215	96	258	333	118	228	186
100-Year											
Regional Regression	130	154	280	232	220	160	291	381	169	291	227
SCS Unit Hydrograph Method	471	556	1,183	1,120	1,325	665	1,580	2,109	833	1,583	1,281
Rational Method	74	95	196	171	234	104	280	362	128	247	202

23.3 Drawings

State of Alaska Department of Transportation and Public Facilities

Haines Highway - MP 3.5 to MP 25.3 Hydrology and Hydraulic Summary Chilkat River and Select Tributaries



SHEET INDEX

- 1 Hydrology and Hydraulics Vicinity Map and Sheet Index
- 2 Chilkat River - Biotechnical Bank Protection Concepts
- 3 Culvert Analysis STA 222+51 Plan View, Section and Profile
- 4 Culvert Analysis STA 319+13 Plan View, Section and Profile
- 5 Culvert Analysis STA 324+79 Plan View, Section and Profile
- 6 Culvert Analysis STA 483+18 Plan View, Section and Profile
- 7 Culvert Analysis STA 512+24 Plan View, Section and Profile
- 8 Culvert Analysis STA 589+12 Plan View, Section and Profile
- 9 Culvert Analysis STA 647+20 Plan View, Section and Profile
- 10 Culvert Analysis STA 710+75 Plan View, Section and Profile
- 11 Culvert Analysis STA 865+88 Plan View, Section and Profile
- 12 Culvert Analysis STA 887+60 Plan View, Section and Profile
- 13 Culvert Analysis STA 1102+19 Plan View, Section and Profile

DRAFT
NOT FOR CONSTRUCTION

				RP DRAWN DM APPROVED	DM DESIGNED 10/28/09 DATE	DM,MS CHECKED PROJECT	State of Alaska Department of Transportation and Public Facilities - Haines, Alaska Haines Highway - MP 3.5 to 25.3	Prepared By: Inter-Fluve, Inc.	1020 Wasco Street, Suite 1 Hood River, OR 97031 541.386.9003 www.interfluve.com	Hydrology and Hydraulics Vicinity Map and Sheet Index	SHEET 1 of 13
NO.	BY	DATE	REVISION DESCRIPTION								

DRAFT
NOT FOR CONSTRUCTION

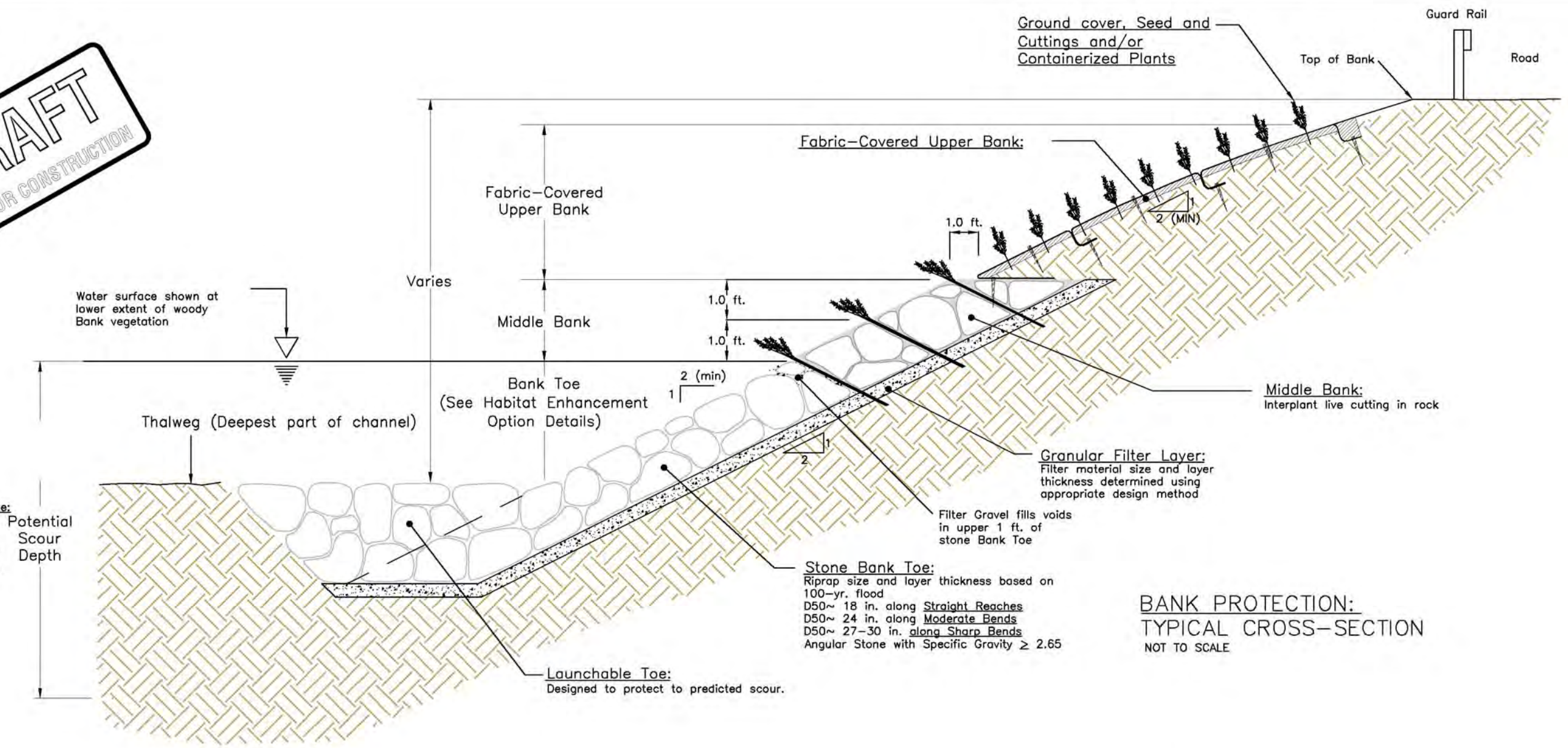

BANK PROTECTION:
TYPICAL CROSS-SECTION
NOT TO SCALE

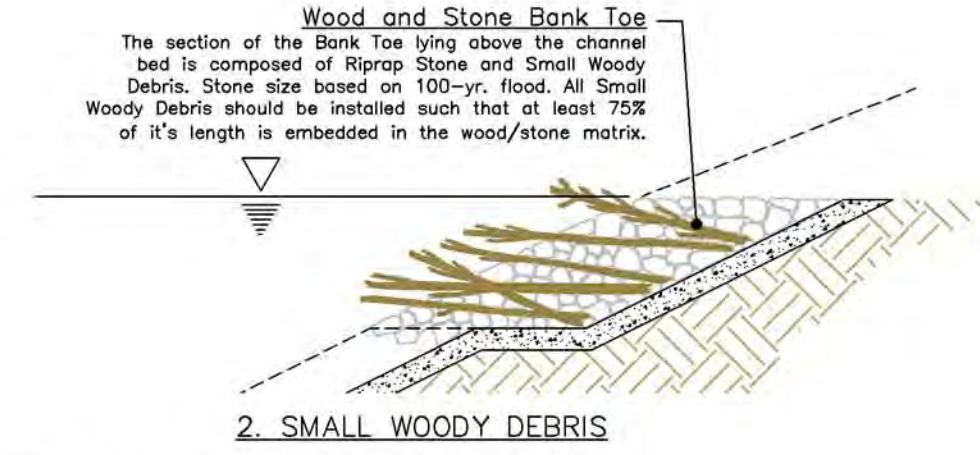
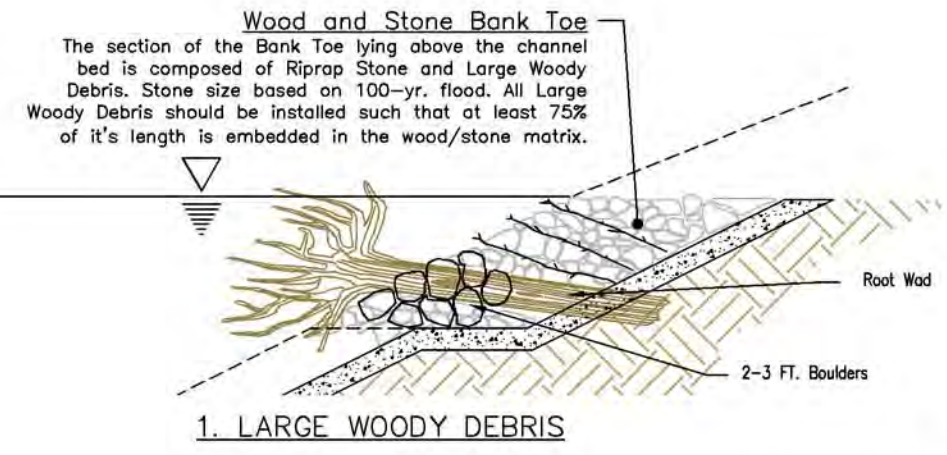

BANK TOE HABITAT ENHANCEMENT OPTIONS
These options recommended only along straight reaches, not at outside of bends.

NO.	BY	DATE	REVISION DESCRIPTION

RP DRAWN	DM DESIGNED	DM,MS CHECKED
DM APPROVED	10/28/09 DATE	PROJECT

State of Alaska Department of Transportation
and Public Facilities – Haines, Alaska
Haines Highway – MP 3.5 to 25.3

Prepared By:
Inter-Fluve, Inc.

1020 Wasco Street, Suite 1
Hood River, OR 97031
541.386.9003
www.interfluve.com

Chilkat River – Biotechnical
Bank Protection Concepts

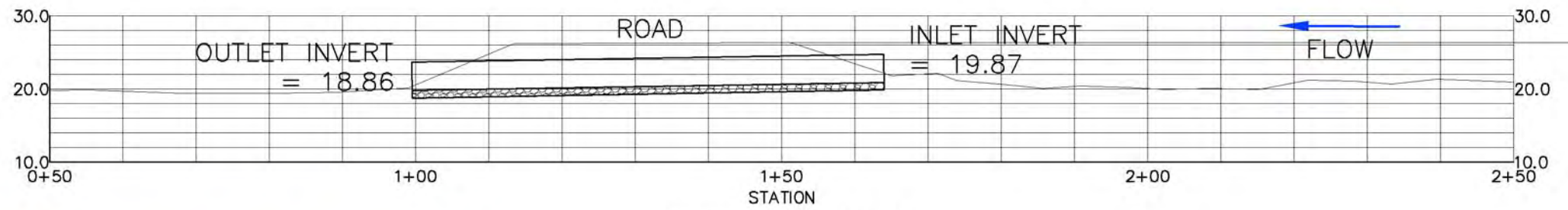

CHANNEL PROFILE



PLAN VIEW

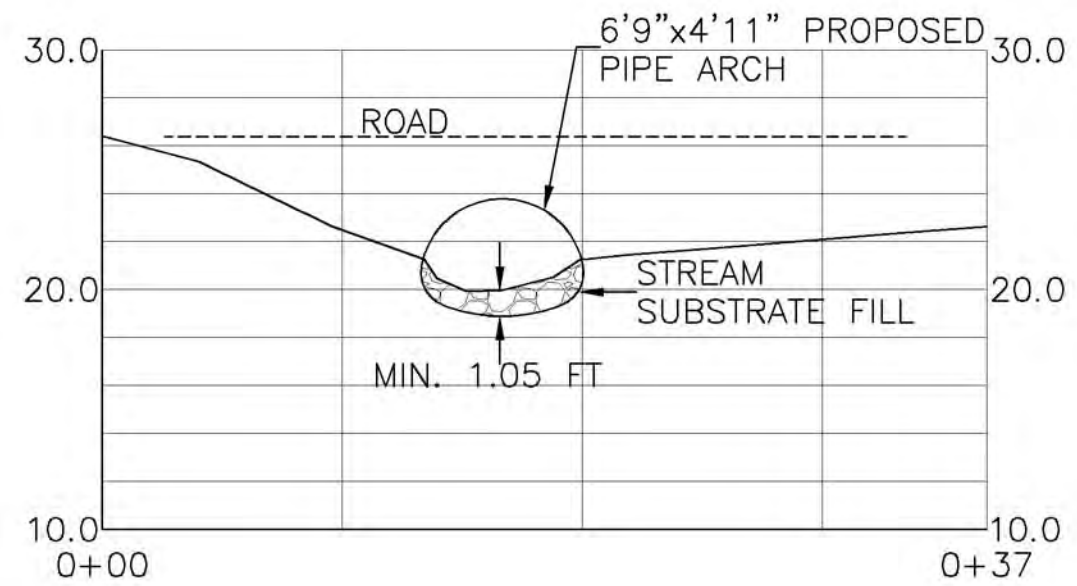
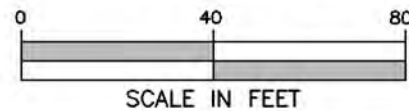

REPRESENTATIVE SECTION VIEW

DRAFT
NOT FOR CONSTRUCTION

- NOTE:
INCLUDE BY REFERENCE - ALASKA DEPARTMENT OF TRANSPORTATION AND PUBLIC FACILITIES (ADOT&PF).
1. STANDARD SPECIFICATIONS FOR HIGHWAY CONSTRUCTION.
 2. STANDARD DRAWINGS: D-DRAINAGE-CULVERTS AND SEWERS.
 3. ALIGNMENT PROVIDED BY DOWL HKM (APRIL 2009)
 4. CONCEPTUAL DESIGN BASED ON PROFILE AND CROSS SECTION DATA RECORDED BY INTER-FLUVE. RELATIVE DATUM = 100 FT. SITE SURVEY WILL BE REQUIRED FOR FINAL DESIGN.

NO.	BY	DATE	REVISION DESCRIPTION

RP	DM	DM,MS
DRAWN	DESIGNED	CHECKED
DM	10/28/09	
APPROVED	DATE	PROJECT

State of Alaska Department of Transportation and Public Facilities - Haines, Alaska
Haines Highway - MP 3.5 to 25.3

Prepared By:
Inter-Fluve, Inc.

1020 Wasco Street, Suite 1
Hood River, OR 97031
541.386.9003
www.interfluve.com

Culvert Analysis STA 222+51
Plan View, Section and Profile

SHEET
3 of 13

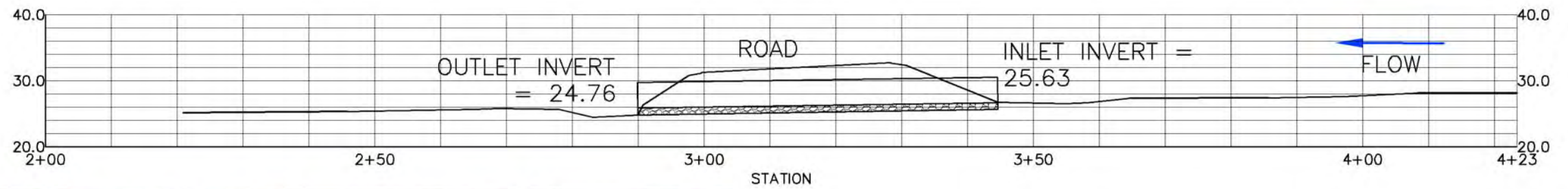

CHANNEL PROFILE



PLAN VIEW

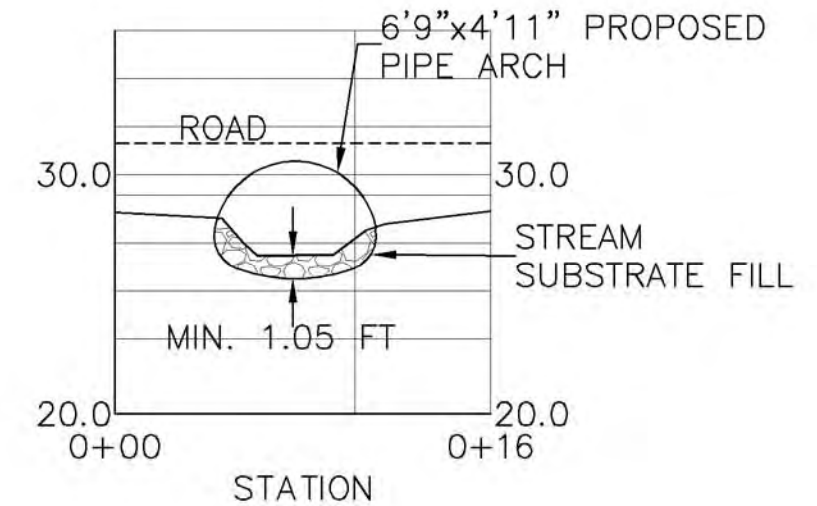

REPRESENTATIVE SECTION VIEW

DRAFT
NOT FOR CONSTRUCTION

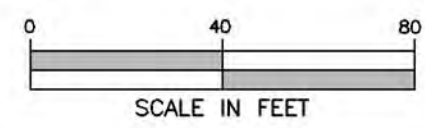

NOTE:
INCLUDE BY REFERENCE - ALASKA DEPARTMENT OF TRANSPORTATION AND PUBLIC FACILITIES (ADOT&PF).
1. STANDARD SPECIFICATIONS FOR HIGHWAY CONSTRUCTION.
2. STANDARD DRAWINGS: D-DRAINAGE-CULVERTS AND SEWERS.
3. ALIGNMENT PROVIDED BY DOWL HKM (APRIL 2009)
4. CONCEPTUAL DESIGN BASED ON PROFILE AND CROSS SECTION DATA RECORDED BY INTER-FLUVE. RELATIVE DATUM = 100 FT. SITE SURVEY WILL BE REQUIRED FOR FINAL DESIGN.

NO.	BY	DATE	REVISION DESCRIPTION

RP	DM	DM,MS
DRAWN	DESIGNED	CHECKED
DM	10/28/09	
APPROVED	DATE	PROJECT

State of Alaska Department of Transportation and Public Facilities - Haines, Alaska
Haines Highway - MP 3.5 to 25.3

Prepared By:
Inter-Fluve, Inc.

1020 Wasco Street, Suite 1
Hood River, OR 97031
541.386.9003
www.interfluve.com

Culvert Analysis STA 319+13
Plan View, Section and Profile

SHEET
4 of 13

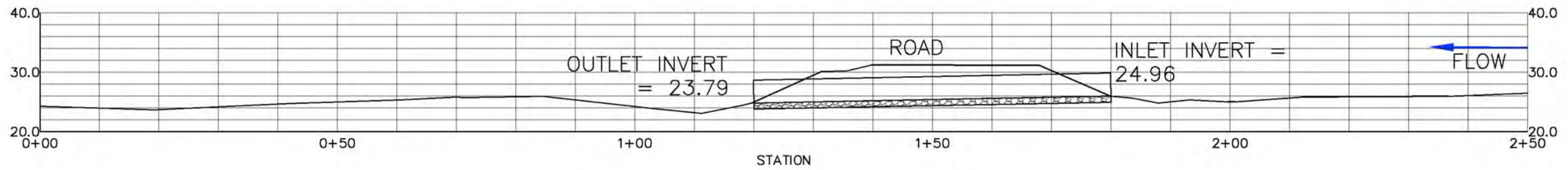

CHANNEL PROFILE

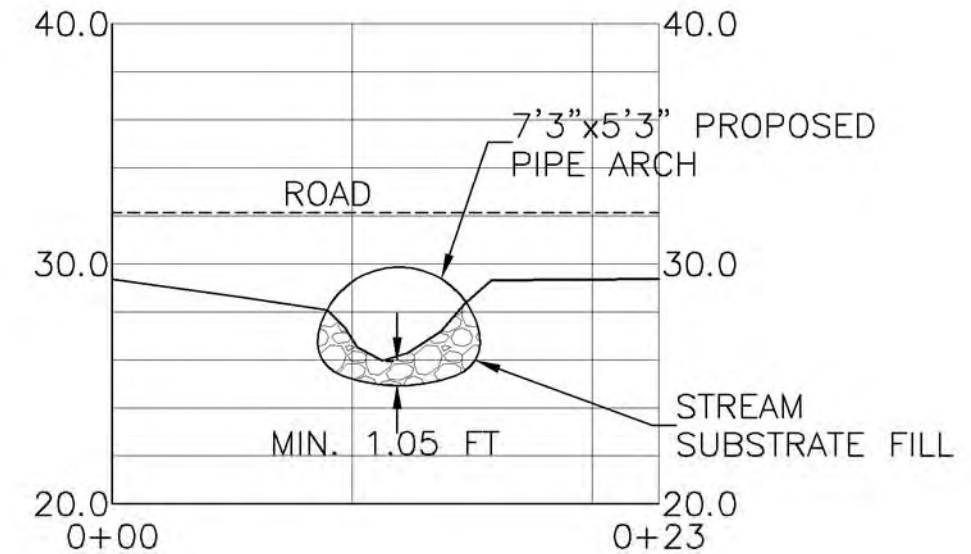
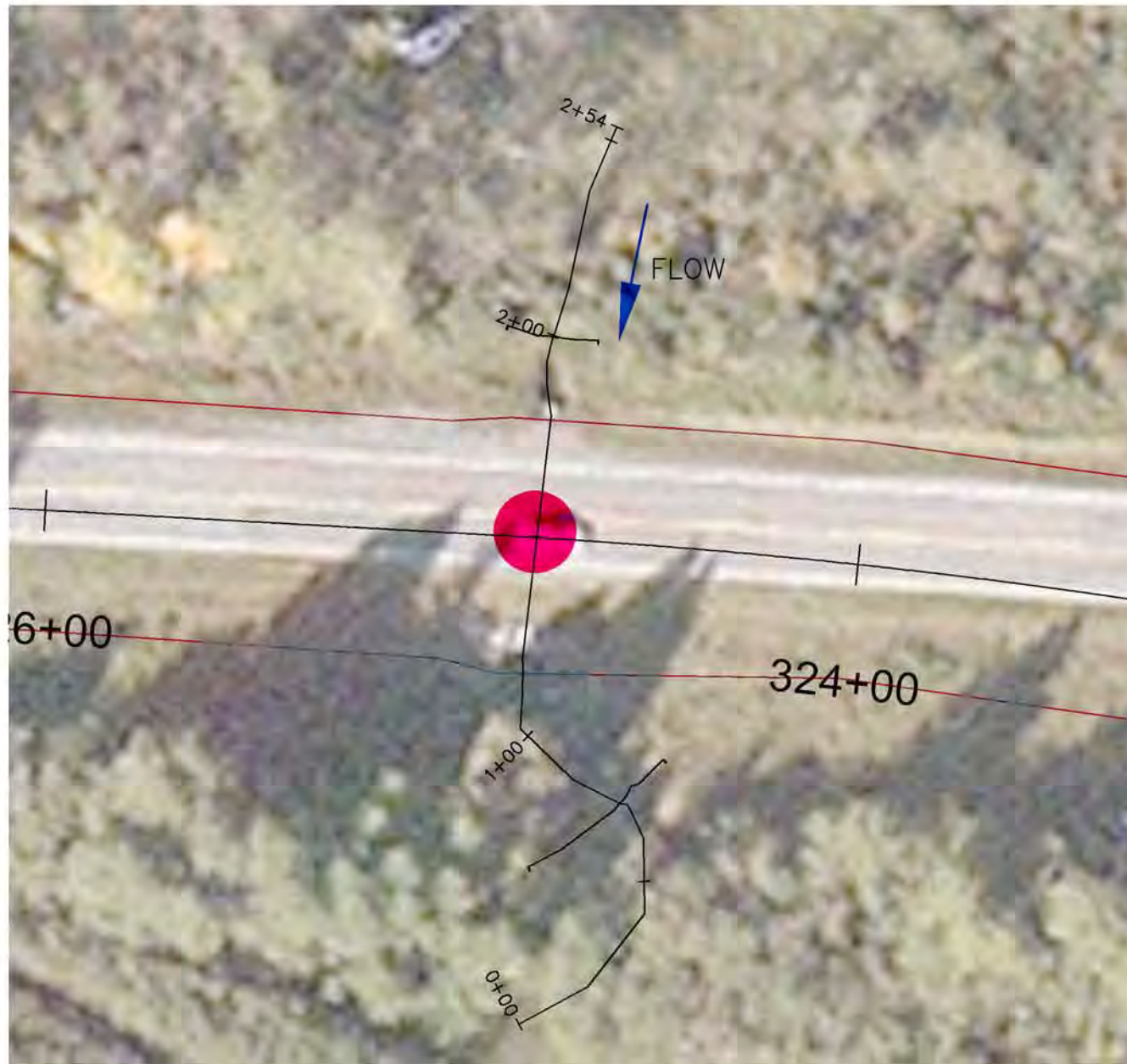

REPRESENTATIVE SECTION VIEW

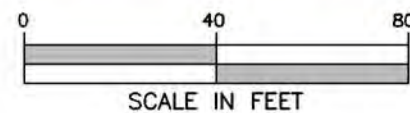

PLAN VIEW

DRAFT
NOT FOR CONSTRUCTION

NOTE:
INCLUDE BY REFERENCE - ALASKA DEPARTMENT OF TRANSPORTATION AND PUBLIC FACILITIES (ADOT&PF).
1. STANDARD SPECIFICATIONS FOR HIGHWAY CONSTRUCTION.
2. STANDARD DRAWINGS: D-DRAINAGE-CULVERTS AND SEWERS.
3. ALIGNMENT PROVIDED BY DOWL HKM (APRIL 2009)
4. CONCEPTUAL DESIGN BASED ON PROFILE AND CROSS SECTION DATA RECORDED BY INTER-FLUVE. RELATIVE DATUM = 100 FT. SITE SURVEY WILL BE REQUIRED FOR FINAL DESIGN.

NO.	BY	DATE	REVISION DESCRIPTION

RP	DM	DM,MS
DRAWN	DESIGNED	CHECKED
DM	10/28/09	
APPROVED	DATE	PROJECT

State of Alaska Department of Transportation and Public Facilities - Haines, Alaska
Haines Highway - MP 3.5 to 25.3

Prepared By:
Inter-Fluve, Inc.

1020 Wasco Street, Suite 1
Hood River, OR 97031
541.386.9003
www.interfluve.com

Culvert Analysis STA 324+79
Plan View, Section and Profile

SHEET
5 of 13

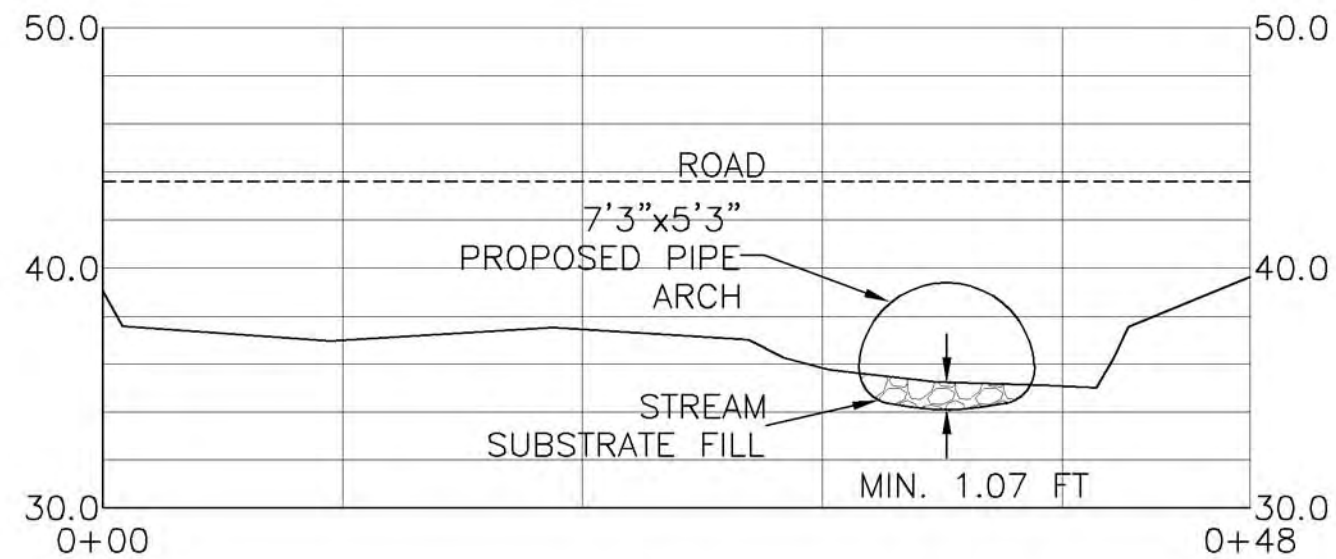
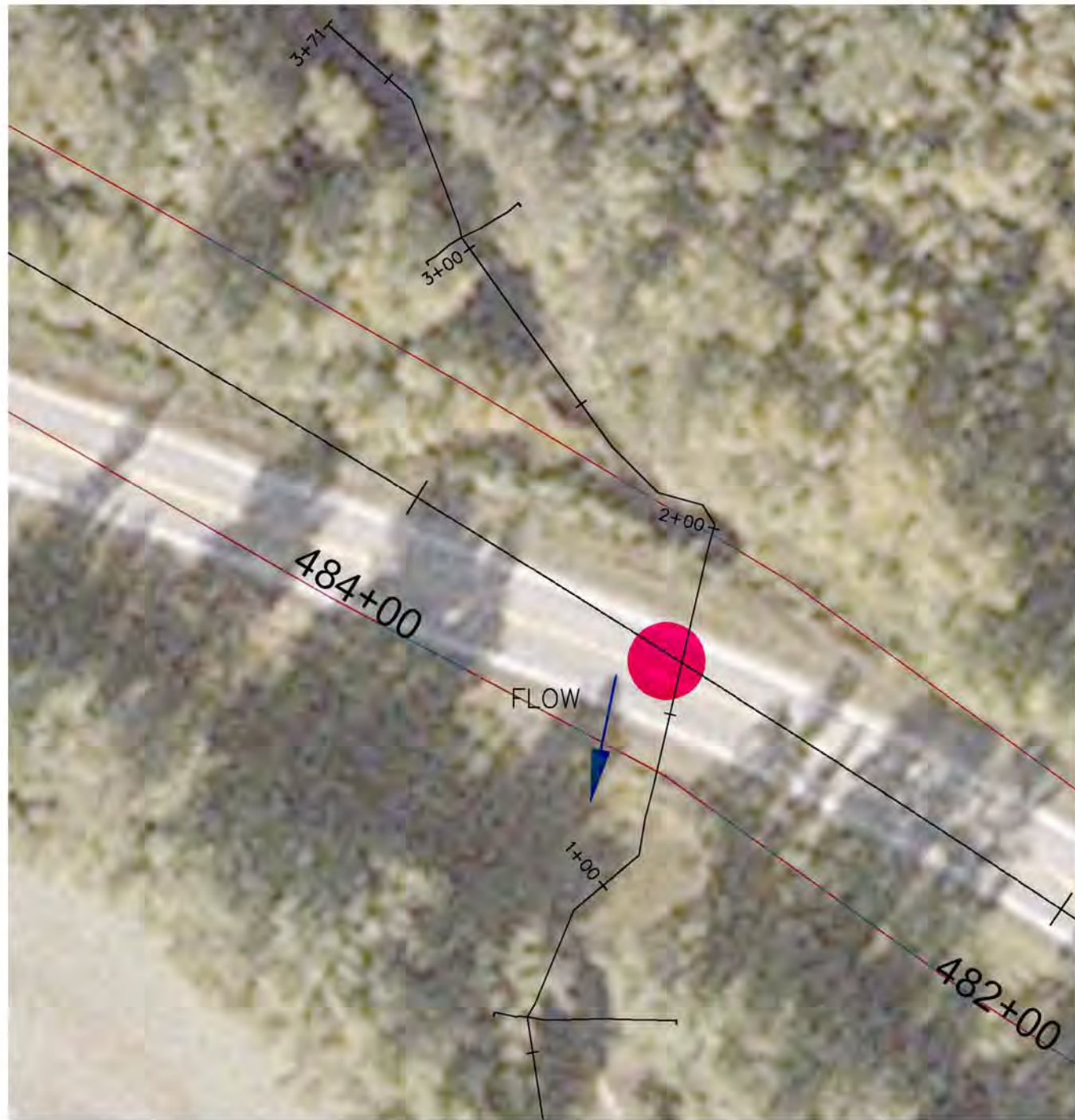
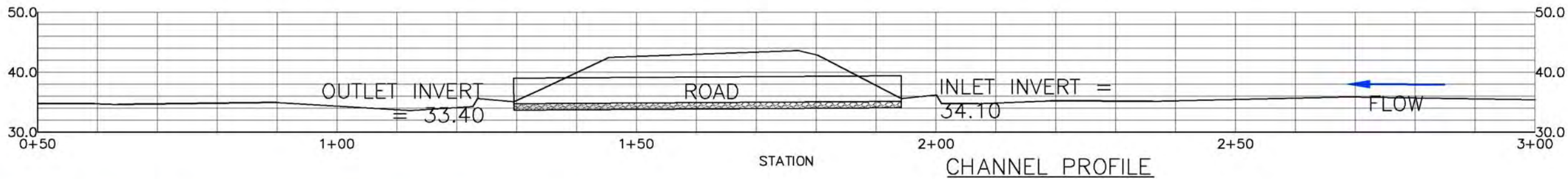

NOTE:
 INCLUDE BY REFERENCE - ALASKA DEPARTMENT OF TRANSPORTATION AND PUBLIC FACILITIES (ADOT&PF).
 1. STANDARD SPECIFICATIONS FOR HIGHWAY CONSTRUCTION.
 2. STANDARD DRAWINGS: D-DRAINAGE-CULVERTS AND SEWERS.
 3. ALIGNMENT PROVIDED BY DOWL HKM (APRIL 2009)
 4. CONCEPTUAL DESIGN BASED ON PROFILE AND CROSS SECTION DATA RECORDED BY INTER-FLUVE. RELATIVE DATUM = 100 FT. SITE SURVEY WILL BE REQUIRED FOR FINAL DESIGN.

DRAFT
 NOT FOR CONSTRUCTION

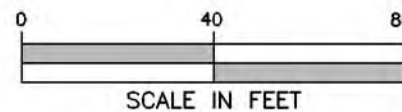

NO.	BY	DATE	REVISION DESCRIPTION

RP	DM	DM,MS
DRAWN	DESIGNED	CHECKED
DM	10/28/09	
APPROVED	DATE	PROJECT

State of Alaska Department of Transportation and Public Facilities - Haines, Alaska
 Haines Highway - MP 3.5 to 25.3

Prepared By:
 Inter-Fluve, Inc.

1020 Wasco Street, Suite 1
 Hood River, OR 97031
 541.386.9003
 www.interfluve.com

Culvert Analysis STA 483+18
 Plan View, Section and Profile

SHEET
 6 of 13

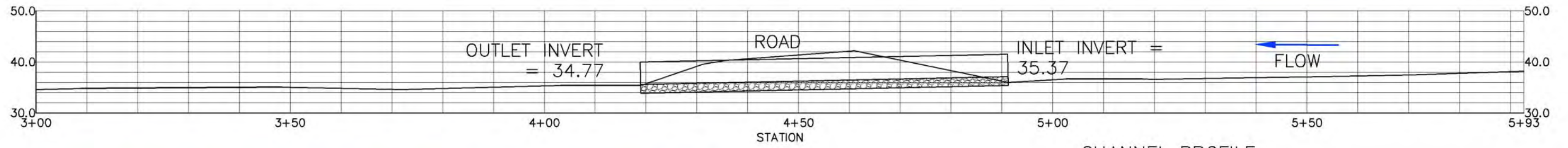

CHANNEL PROFILE



PLAN VIEW

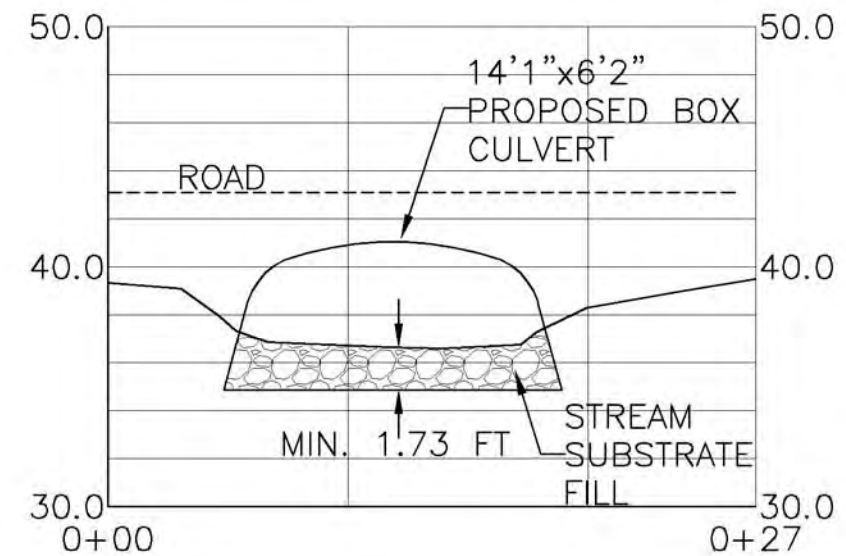

REPRESENTATIVE SECTION VIEW

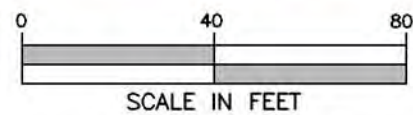

DRAFT
NOT FOR CONSTRUCTION

NOTE:
INCLUDE BY REFERENCE - ALASKA DEPARTMENT OF TRANSPORTATION AND PUBLIC FACILITIES (ADOT&PF).
1. STANDARD SPECIFICATIONS FOR HIGHWAY CONSTRUCTION.
2. STANDARD DRAWINGS: D-DRAINAGE-CULVERTS AND SEWERS.
3. ALIGNMENT PROVIDED BY DOWL HKM (APRIL 2009)
4. CONCEPTUAL DESIGN BASED ON PROFILE AND CROSS SECTION DATA RECORDED BY INTER-FLUVE. RELATIVE DATUM = 100 FT. SITE SURVEY WILL BE REQUIRED FOR FINAL DESIGN.

NO.	BY	DATE	REVISION DESCRIPTION

RP	DM	DM,MS
DRAWN	DESIGNED	CHECKED
DM	10/28/09	
APPROVED	DATE	PROJECT

State of Alaska Department of Transportation and Public Facilities - Haines, Alaska
Haines Highway - MP 3.5 to 25.3

Prepared By:
Inter-Fluve, Inc.

1020 Wasco Street, Suite 1
Hood River, OR 97031
541.386.9003
www.interfluve.com

Culvert Analysis STA 512+24
Plan View, Section and Profile

SHEET
7 OF 13

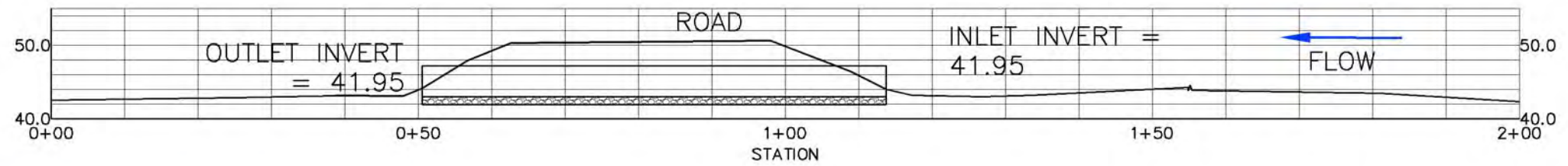

CHANNEL PROFILE



PLAN VIEW

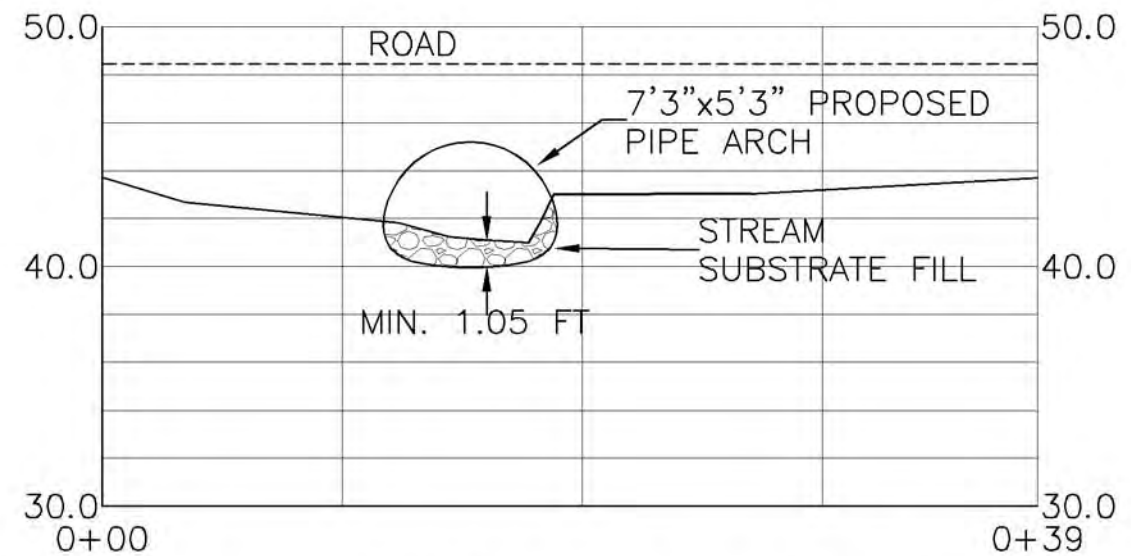

REPRESENTATIVE SECTION VIEW

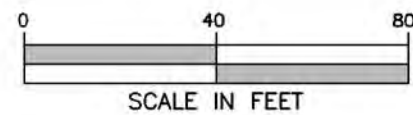

DRAFT
NOT FOR CONSTRUCTION

NOTE:
INCLUDE BY REFERENCE - ALASKA DEPARTMENT OF TRANSPORTATION AND PUBLIC FACILITIES (ADOT&PF).
1. STANDARD SPECIFICATIONS FOR HIGHWAY CONSTRUCTION.
2. STANDARD DRAWINGS: D-DRAINAGE-CULVERTS AND SEWERS.
3. ALIGNMENT PROVIDED BY DOWL HKM (APRIL 2009)
4. CONCEPTUAL DESIGN BASED ON PROFILE AND CROSS SECTION DATA RECORDED BY INTER-FLUVE. RELATIVE DATUM = 100 FT. SITE SURVEY WILL BE REQUIRED FOR FINAL DESIGN.

NO.	BY	DATE	REVISION DESCRIPTION

RP	DM	DM,MS
DRAWN	DESIGNED	CHECKED
DM	10/28/09	
APPROVED	DATE	PROJECT

State of Alaska Department of Transportation and Public Facilities - Haines, Alaska
Haines Highway - MP 3.5 to 25.3

Prepared By:
Inter-Fluve, Inc.

1020 Wasco Street, Suite 1
Hood River, OR 97031
541.386.9003
www.interfluve.com

Culvert Analysis STA 589+12
Plan View, Section and Profile

SHEET
8 of 13

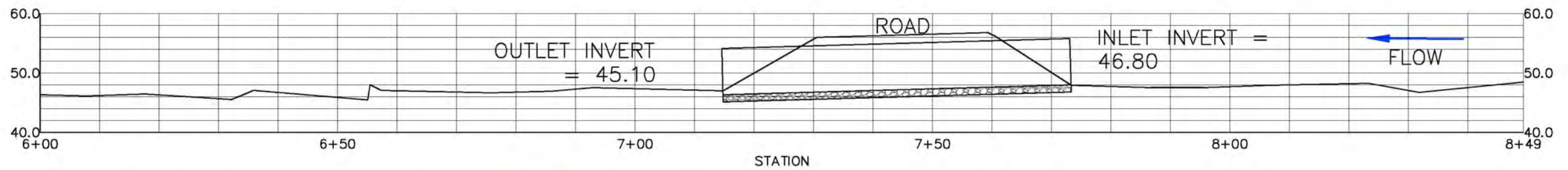

CHANNEL PROFILE

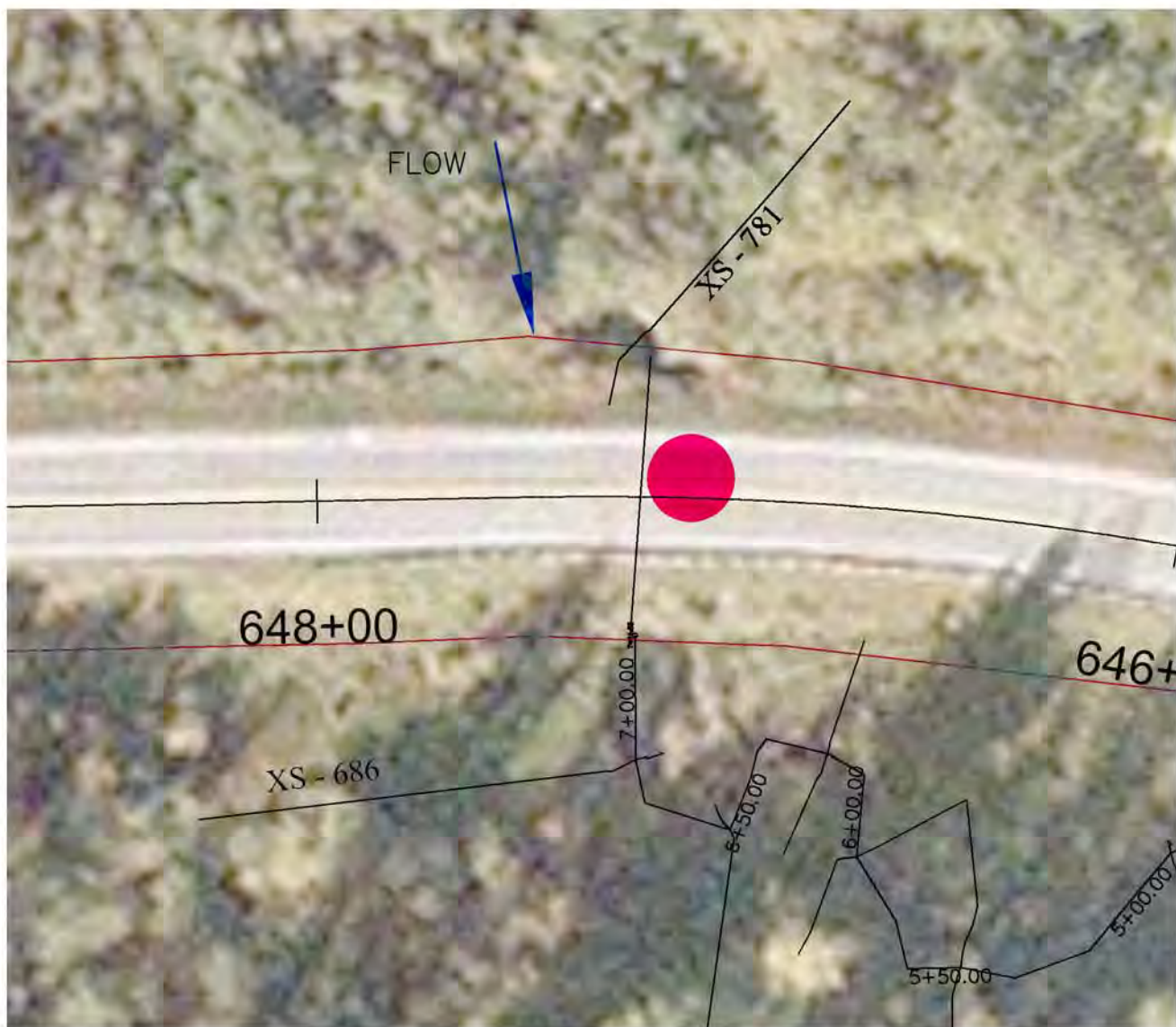

PLAN VIEW

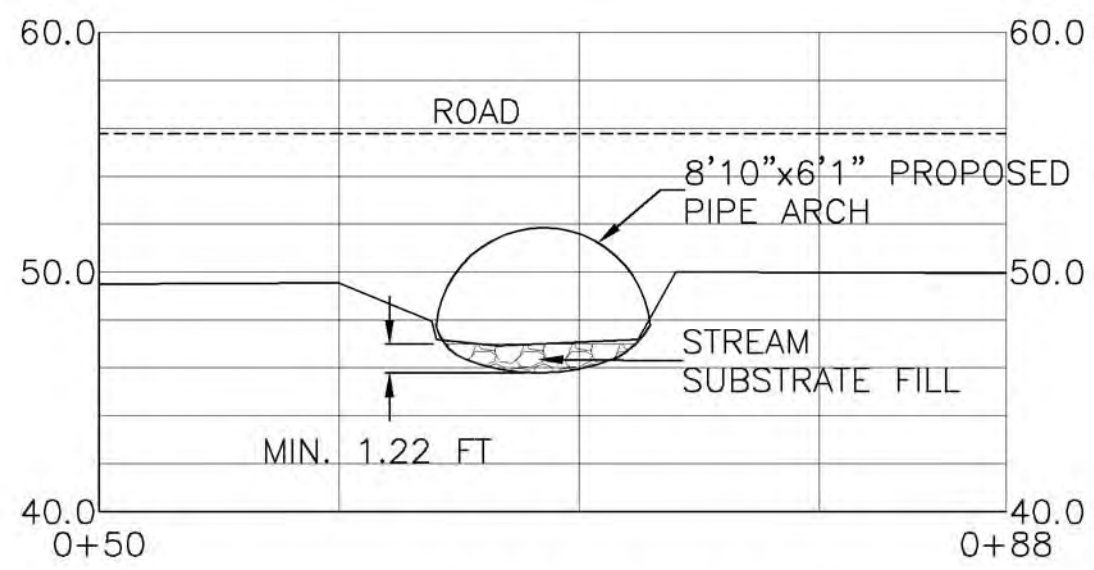

REPRESENTATIVE SECTION VIEW

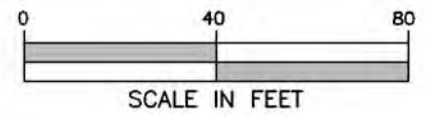

DRAFT
NOT FOR CONSTRUCTION

NOTE:
INCLUDE BY REFERENCE - ALASKA DEPARTMENT OF TRANSPORTATION AND PUBLIC FACILITIES (ADOT&PF).
1. STANDARD SPECIFICATIONS FOR HIGHWAY CONSTRUCTION.
2. STANDARD DRAWINGS: D-DRAINAGE-CULVERTS AND SEWERS.
3. ALIGNMENT PROVIDED BY DOWL HKM (APRIL 2009)
4. SURVEY BASED ON ADOT&PF PROJECT DATUM.

NO.	BY	DATE	REVISION DESCRIPTION

RP	DM	DM,MS
DRAWN	DESIGNED	CHECKED
DM	10/28/09	
APPROVED	DATE	PROJECT

State of Alaska Department of Transportation and Public Facilities - Haines, Alaska
Haines Highway - MP 3.5 to 25.3

Prepared By:
Inter-Fluve, Inc.
1020 Wasco Street, Suite 1
Hood River, OR 97031
541.386.9003
www.interfluve.com

Culvert Analysis STA 647+20
Plan View, Section and Profile

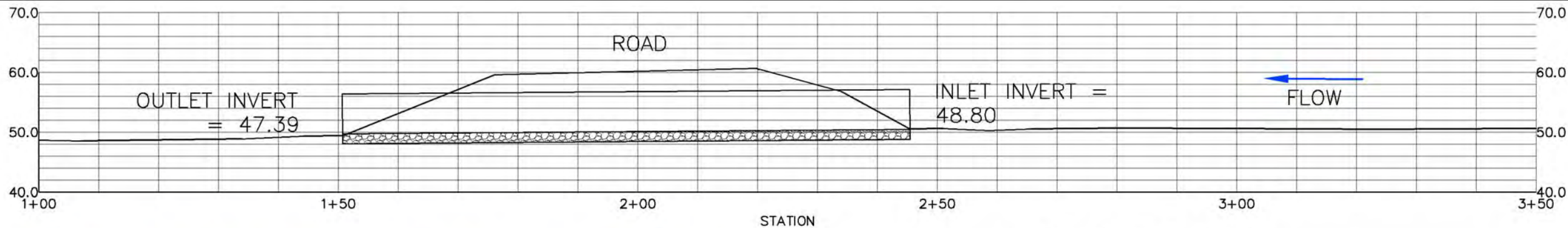

CHANNEL PROFILE

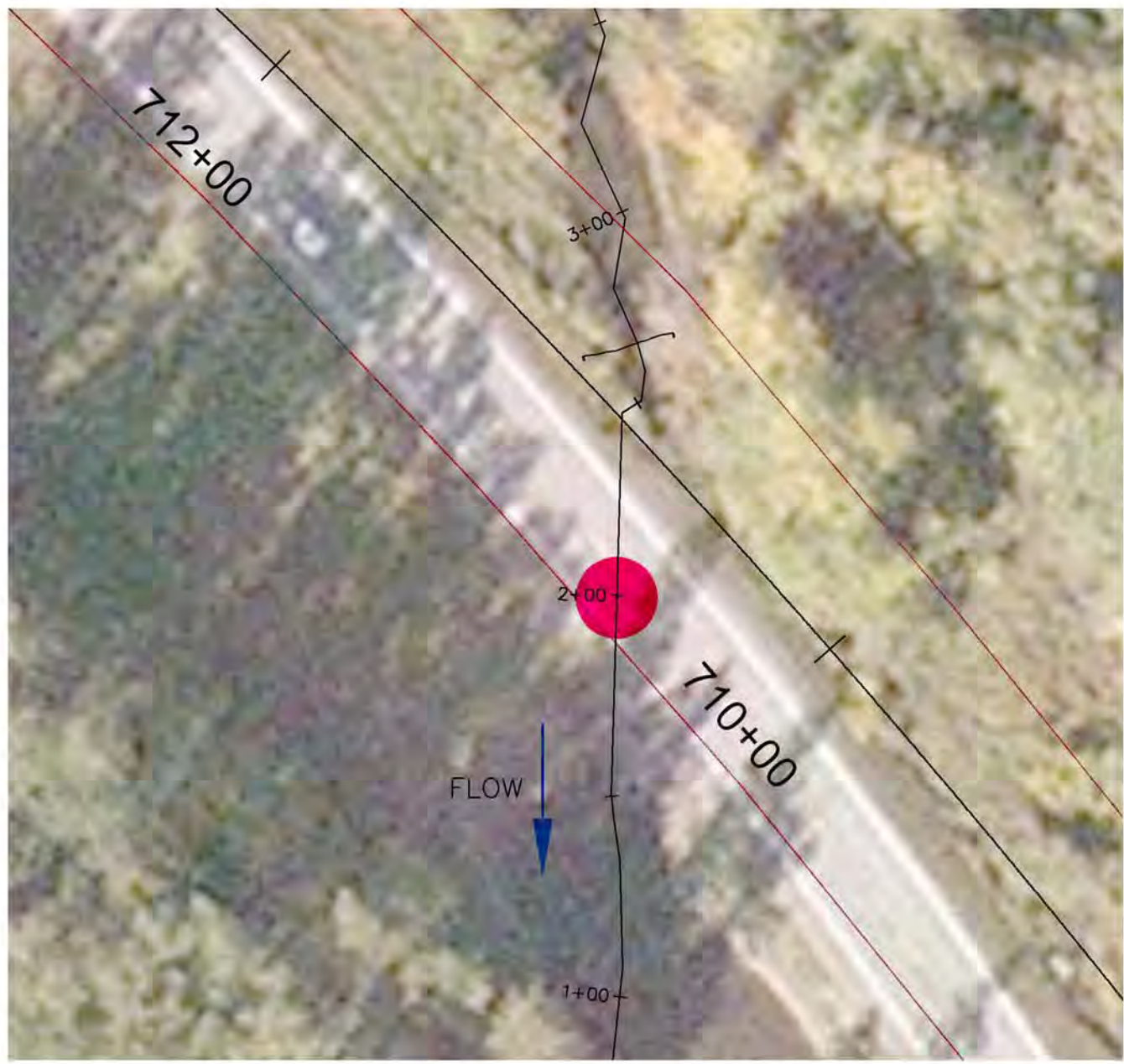

PLAN VIEW

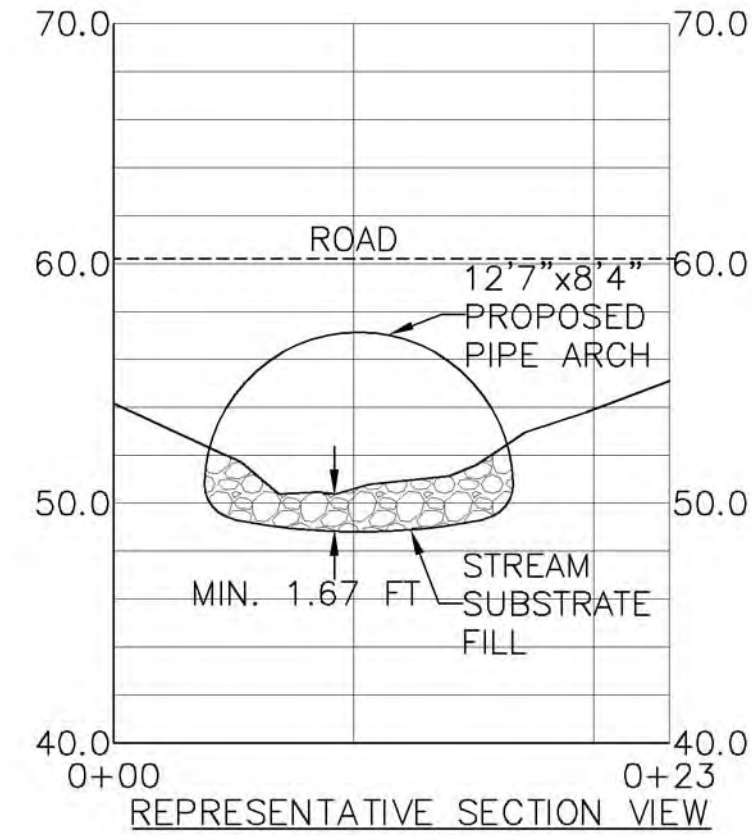
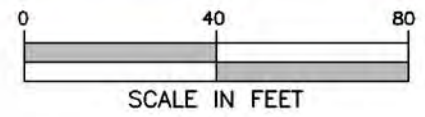

REPRESENTATIVE SECTION VIEW

DRAFT
NOT FOR CONSTRUCTION

NOTE:
INCLUDE BY REFERENCE - ALASKA DEPARTMENT OF TRANSPORTATION AND PUBLIC FACILITIES (ADOT&PF).
1. STANDARD SPECIFICATIONS FOR HIGHWAY CONSTRUCTION.
2. STANDARD DRAWINGS: D-DRAINAGE-CULVERTS AND SEWERS.
3. ALIGNMENT PROVIDED BY DOWL HKM (APRIL 2009)
4. CONCEPTUAL DESIGN BASED ON PROFILE AND CROSS SECTION DATA RECORDED BY INTER-FLUVE. RELATIVE DATUM = 100 FT. SITE SURVEY WILL BE REQUIRED FOR FINAL DESIGN.

NO.	BY	DATE	REVISION DESCRIPTION

RP	DM	DM,MS
DRAWN	DESIGNED	CHECKED
DM	10/28/09	
APPROVED	DATE	PROJECT

State of Alaska Department of Transportation and Public Facilities - Haines, Alaska
Haines Highway - MP 3.5 to 25.3

Prepared By:
Inter-Fluve, Inc.
1020 Wasco Street, Suite 1
Hood River, OR 97031
541.386.9003
www.interfluve.com

Culvert Analysis STA 710+75
Plan View, Section and Profile

SHEET
10 of 13

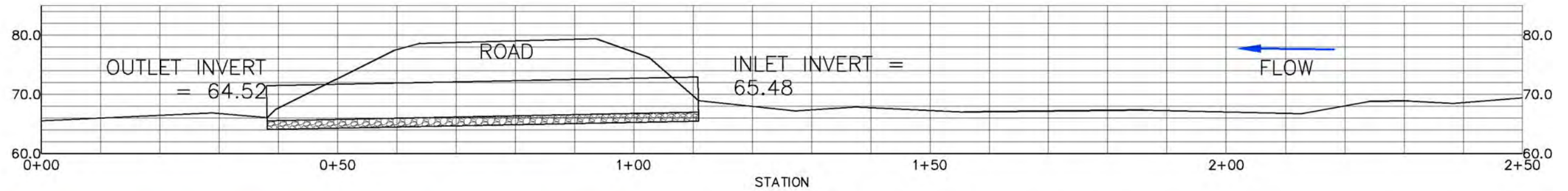

CHANNEL PROFILE

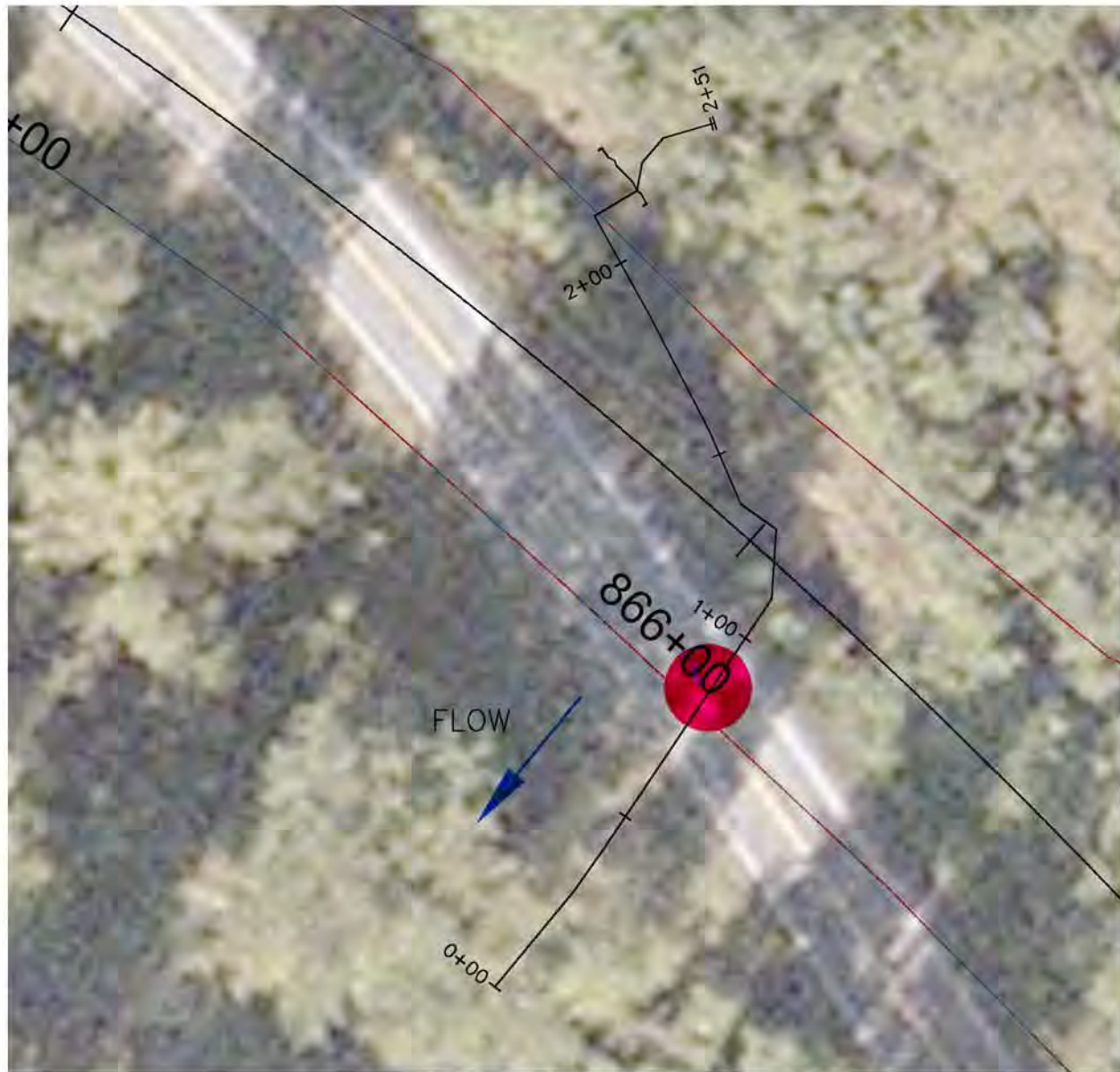

PLAN VIEW

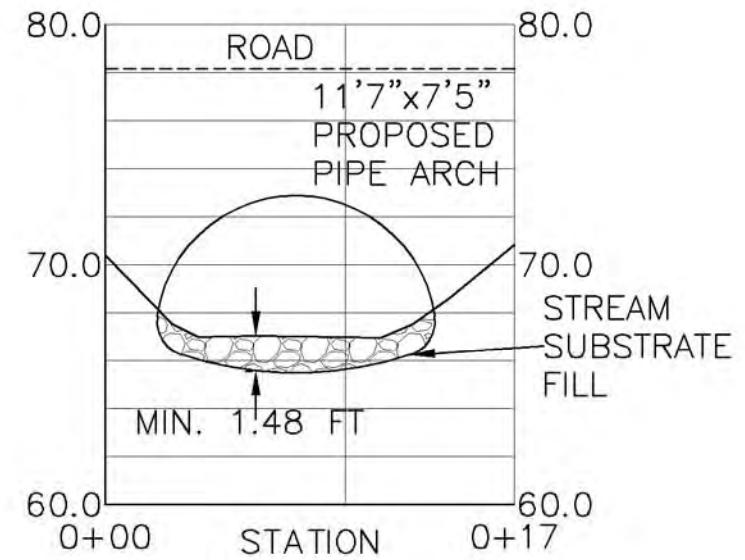

REPRESENTATIVE SECTION VIEW

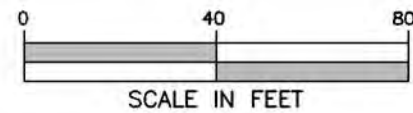

DRAFT
NOT FOR CONSTRUCTION

NOTE:
INCLUDE BY REFERENCE - ALASKA DEPARTMENT OF TRANSPORTATION AND PUBLIC FACILITIES (ADOT&PF).
1. STANDARD SPECIFICATIONS FOR HIGHWAY CONSTRUCTION.
2. STANDARD DRAWINGS: D-DRAINAGE-CULVERTS AND SEWERS.
3. ALIGNMENT PROVIDED BY DOWL HKM (APRIL 2009)
4. CONCEPTUAL DESIGN BASED ON PROFILE AND CROSS SECTION DATA RECORDED BY INTER-FLUVE. RELATIVE DATUM = 100 FT. SITE SURVEY WILL BE REQUIRED FOR FINAL DESIGN.

NO.	BY	DATE	REVISION DESCRIPTION

RP	DM	DM,MS
DRAWN	DESIGNED	CHECKED
DM	10/28/09	
APPROVED	DATE	PROJECT

State of Alaska Department of Transportation and Public Facilities - Haines, Alaska
Haines Highway - MP 3.5 to 25.3

Prepared By:
Inter-Fluve, Inc.

1020 Wasco Street, Suite 1
Hood River, OR 97031
541.386.9003
www.interfluve.com

Culvert Analysis STA 865+88
Plan View, Section and Profile

SHEET
11 of 13

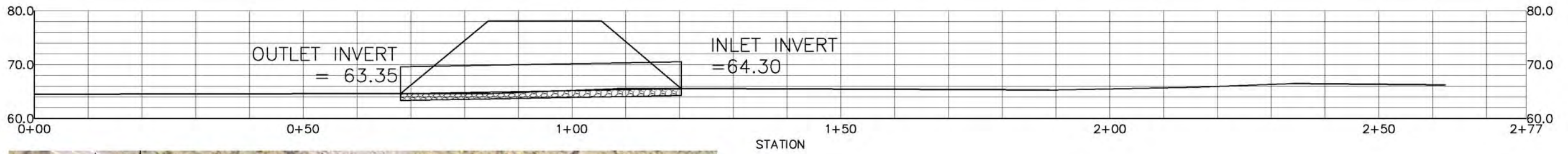

CHANNEL PROFILE

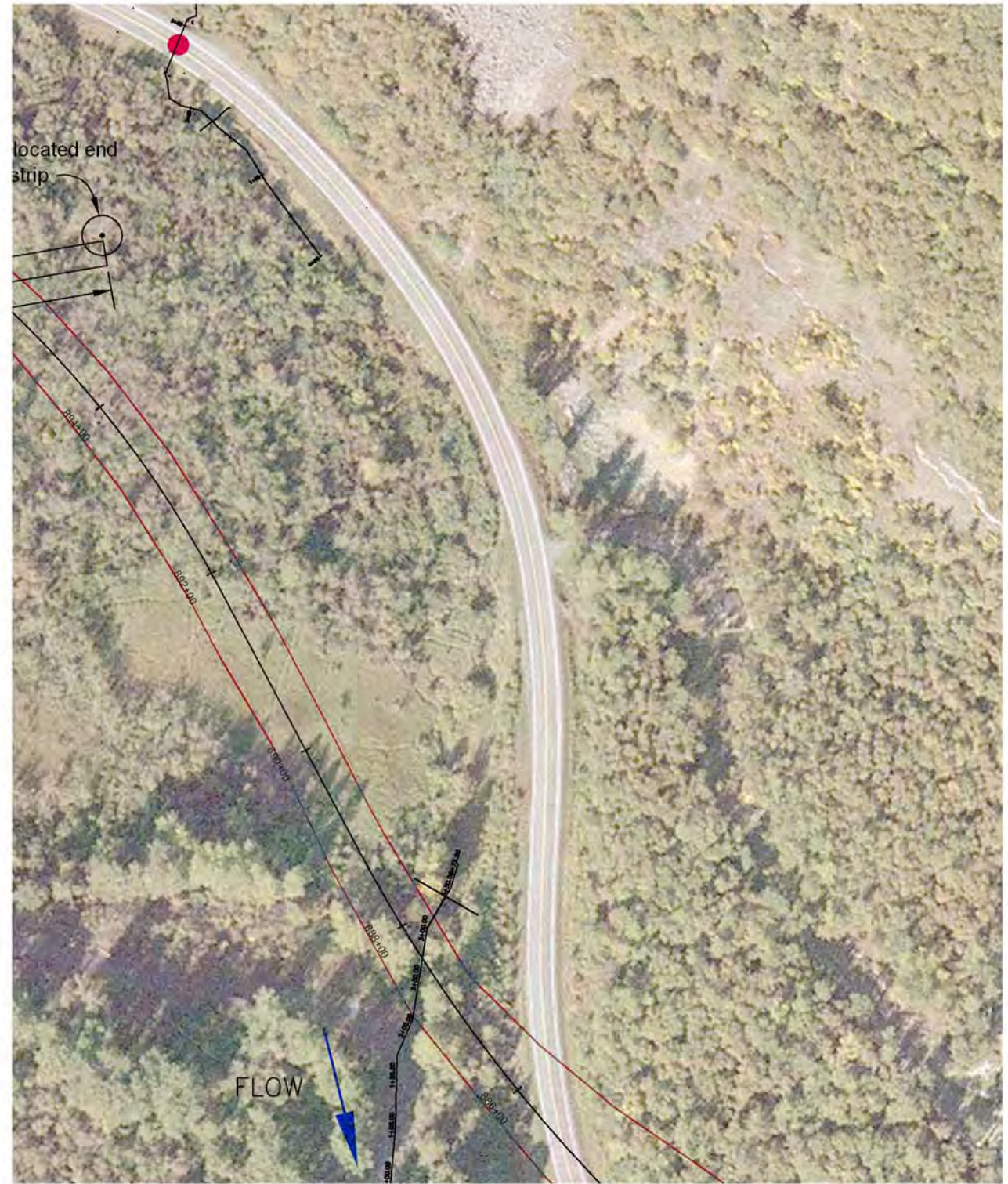

PLAN VIEW

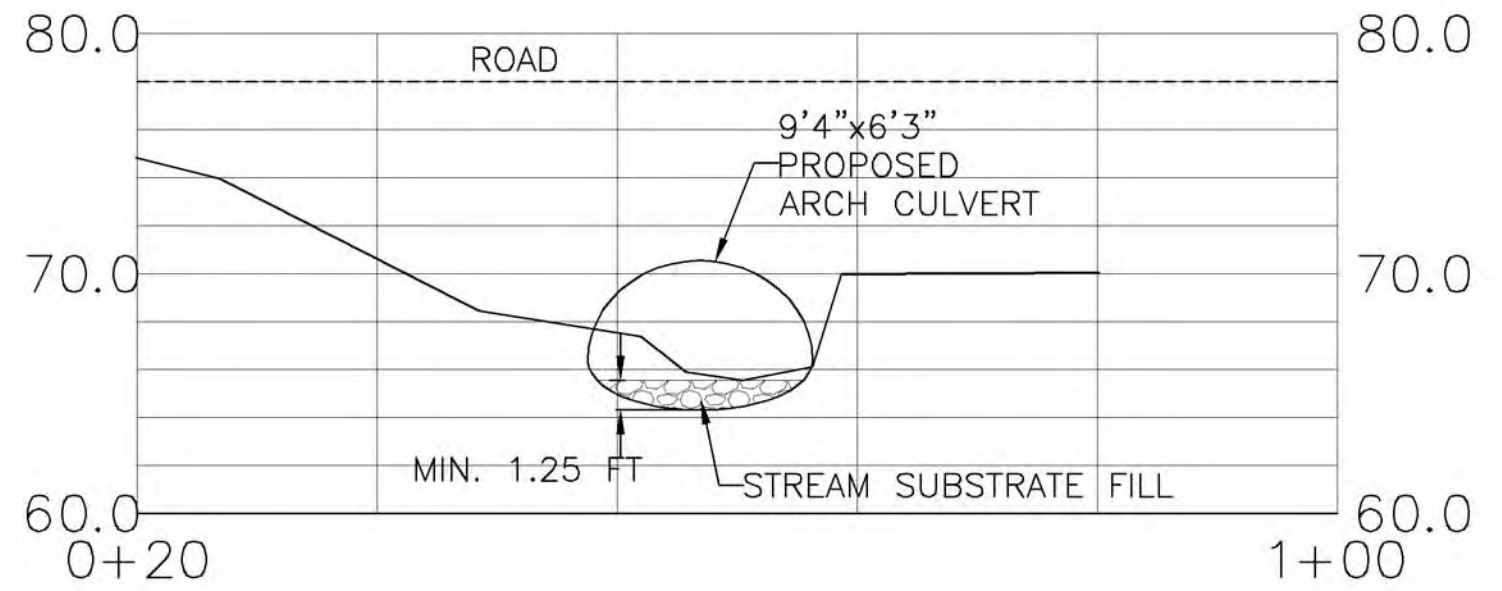

REPRESENTATIVE SECTION VIEW

DRAFT
NOT FOR CONSTRUCTION

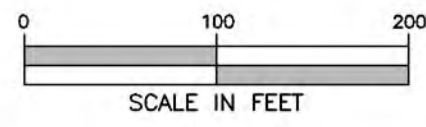

NOTE:
INCLUDE BY REFERENCE - ALASKA DEPARTMENT OF TRANSPORTATION AND PUBLIC FACILITIES (ADOT&PF).
1. STANDARD SPECIFICATIONS FOR HIGHWAY CONSTRUCTION.
2. STANDARD DRAWINGS: D-DRAINAGE-CULVERTS AND SEWERS.
3. ALIGNMENT PROVIDED BY DOWL HKM (APRIL 2009)
4. SURVEY BASED ON ADOT&PF PROJECT DATUM.

NO.	BY	DATE	REVISION DESCRIPTION

RP	DM	DM,MS
DRAWN	DESIGNED	CHECKED
DM	10/28/09	
APPROVED	DATE	PROJECT

State of Alaska Department of Transportation and Public Facilities - Haines, Alaska
Haines Highway - MP 3.5 to 25.3

Prepared By:
Inter-Fluve, Inc.
1020 Wasco Street, Suite 1
Hood River, OR 97031
541.386.9003
www.interfluve.com

Culvert Analysis STA 887+60
Plan View, Section and Profile

SHEET
12 of 13

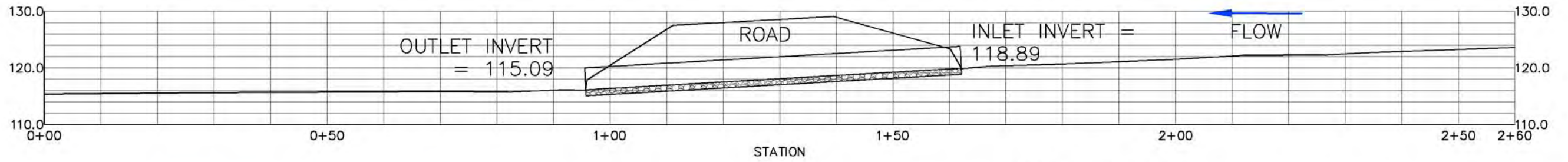

CHANNEL PROFILE



PLAN VIEW

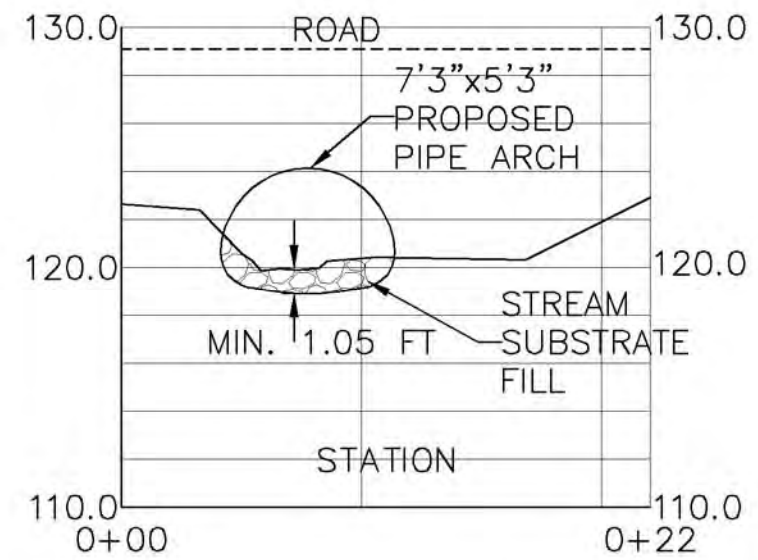

REPRESENTATIVE SECTION VIEW

DRAFT
NOT FOR CONSTRUCTION

NOTE:
INCLUDE BY REFERENCE - ALASKA DEPARTMENT OF TRANSPORTATION AND PUBLIC FACILITIES (ADOT&PF).
1. STANDARD SPECIFICATIONS FOR HIGHWAY CONSTRUCTION.
2. STANDARD DRAWINGS: D-DRAINAGE-CULVERTS AND SEWERS.
3. ALIGNMENT PROVIDED BY DOWL HKM (APRIL 2009)
4. CONCEPTUAL DESIGN BASED ON PROFILE AND CROSS SECTION DATA RECORDED BY INTER-FLUVE. RELATIVE DATUM = 100 FT. SITE SURVEY WILL BE REQUIRED FOR FINAL DESIGN.

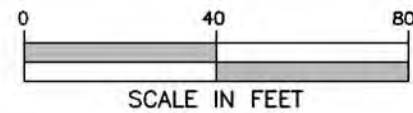

SCALE IN FEET

NO.	BY	DATE	REVISION DESCRIPTION

RP	DM	DM,MS
DRAWN	DESIGNED	CHECKED
DM	10/28/09	
APPROVED	DATE	PROJECT

State of Alaska Department of Transportation and Public Facilities - Haines, Alaska
Haines Highway - MP 3.5 to 25.3

Prepared By:
Inter-Fluve, Inc.

1020 Wasco Street, Suite 1
Hood River, OR 97031
541.386.9003
www.interfluve.com

Culvert Analysis STA 1102+19
Plan View, Section and Profile

SHEET
13 of 13

23.4 Culvert Summary

23.5 Hydraulic Output

23.5.1 Hydraulic Output – Chilkat River

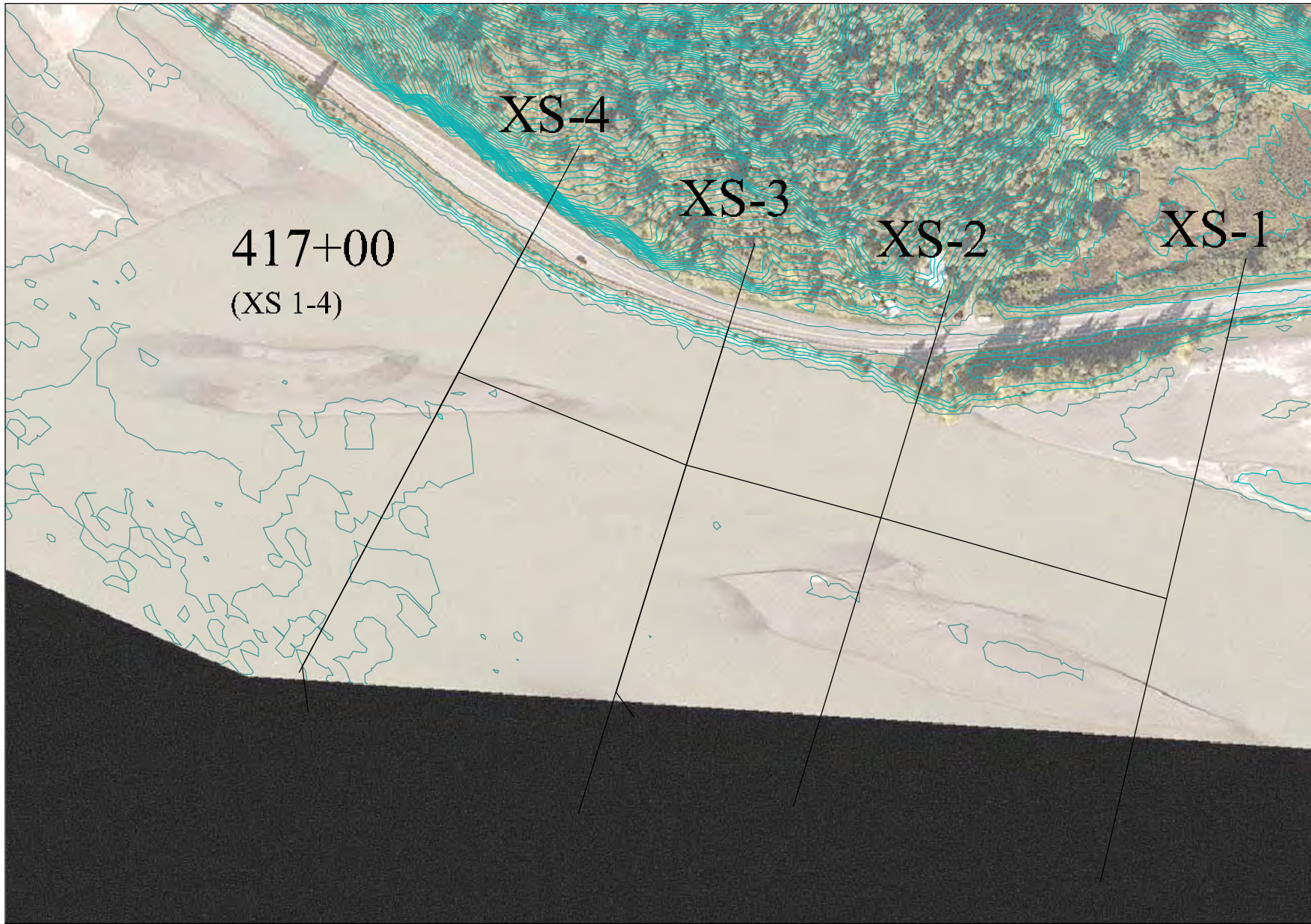

417+00
(XS 1-4)

XS-4

XS-3

XS-2

XS-1

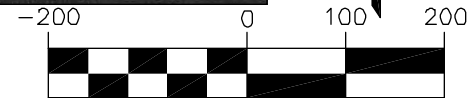

1 inch = 200ft.



Tidal M1 Plan: Tidal M1 - Low tide 9/27/2006

Chilkat River 417+00

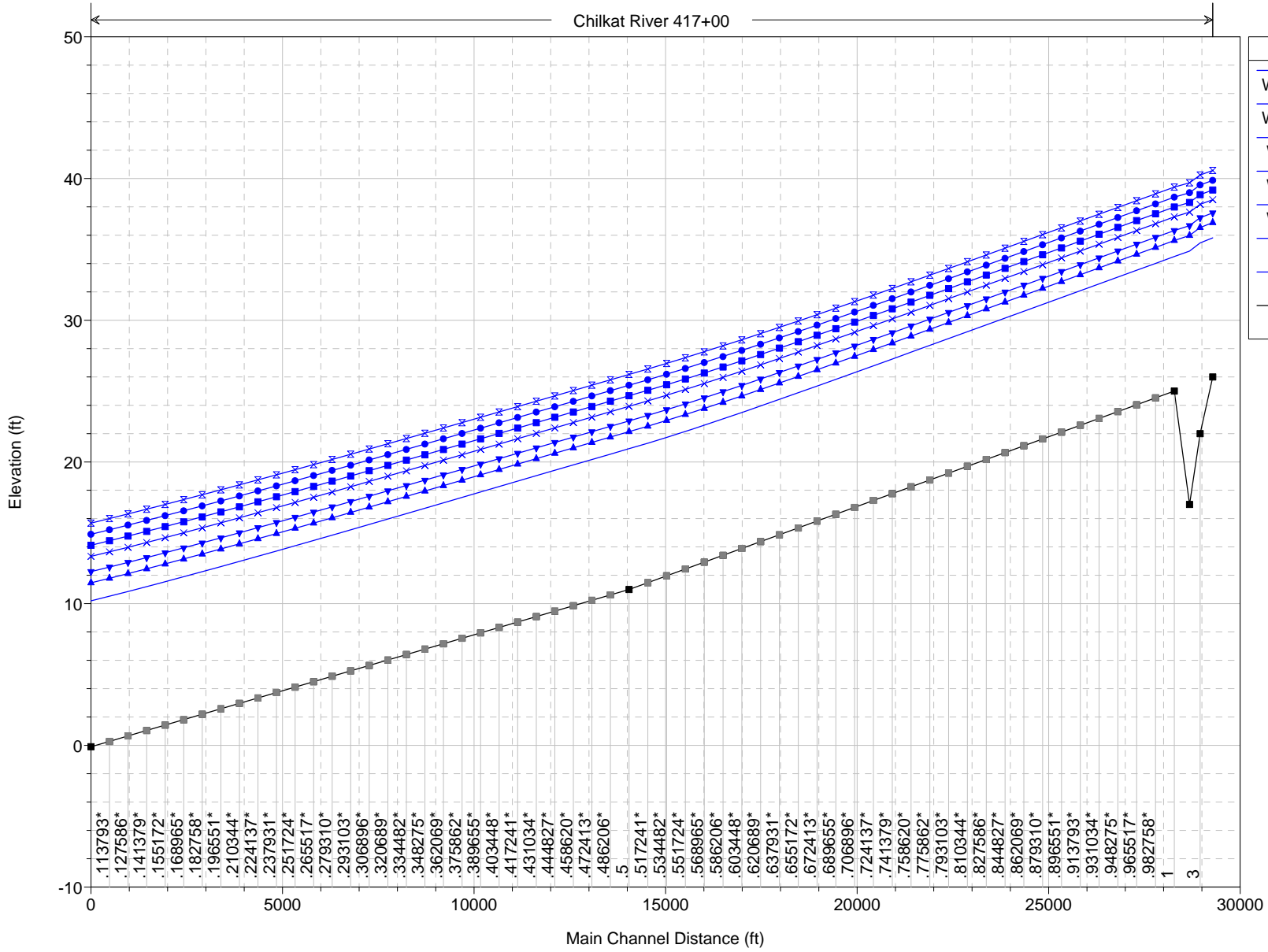

Tidal M1 Plan: Tidal M1 - Low tide 9/27/2006

River = Chilkat River Reach = 417+00 RS = 4 2-points added for typical average depth = 4-ft

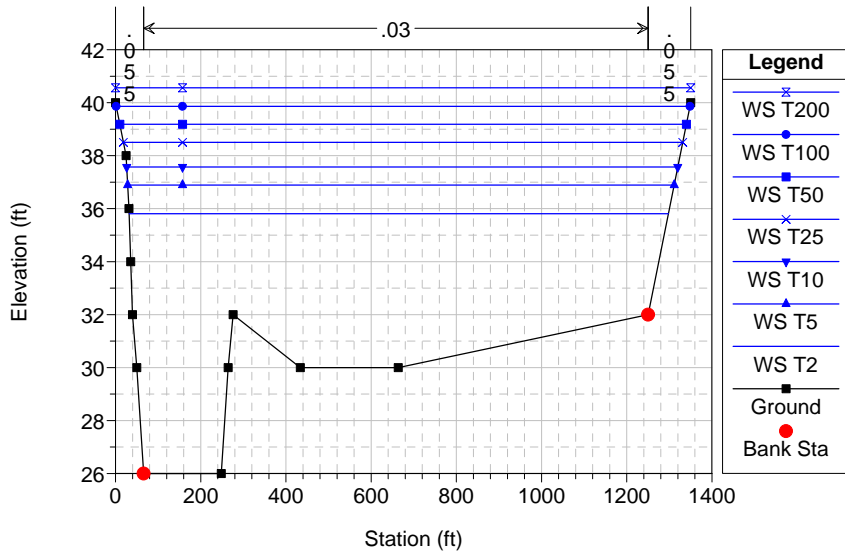

Tidal M1 Plan: Tidal M1 - Low tide 9/27/2006

River = Chilkat River Reach = 417+00 RS = 3 Boat based soundings w. offset visual estimates included

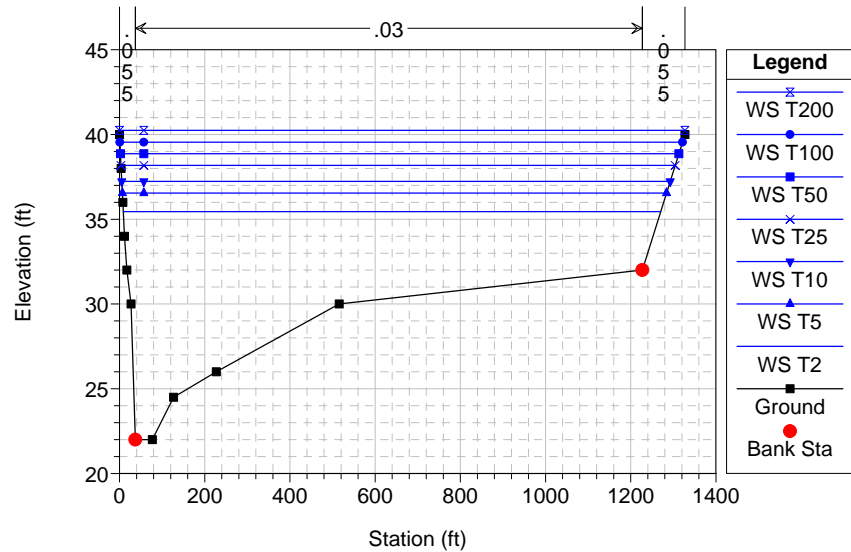

Tidal M1 Plan: Tidal M1 - Low tide 9/27/2006

River = Chilkat River Reach = 417+00 RS = 2 Boat based soundings w. offset visual estimates included

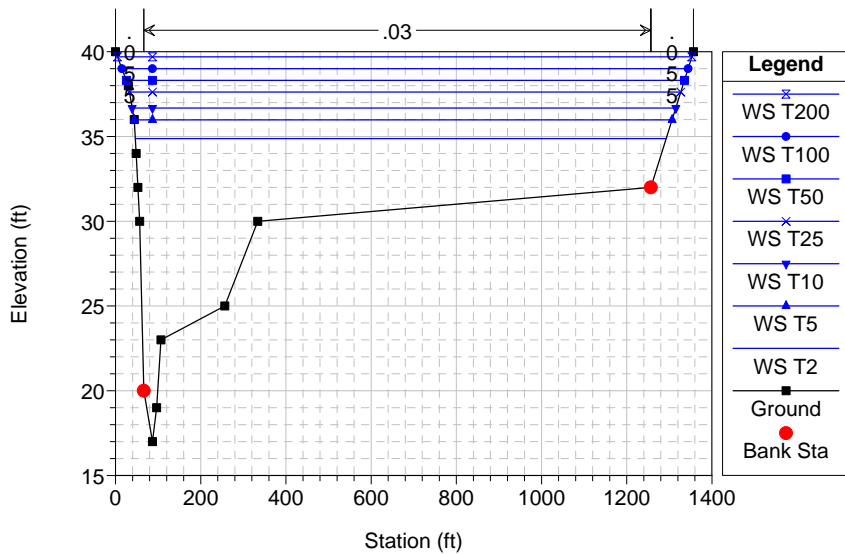

Tidal M1 Plan: Tidal M1 - Low tide 9/27/2006

River = Chilkat River Reach = 417+00 RS = 1 2-points added for typical average depth = 5-ft

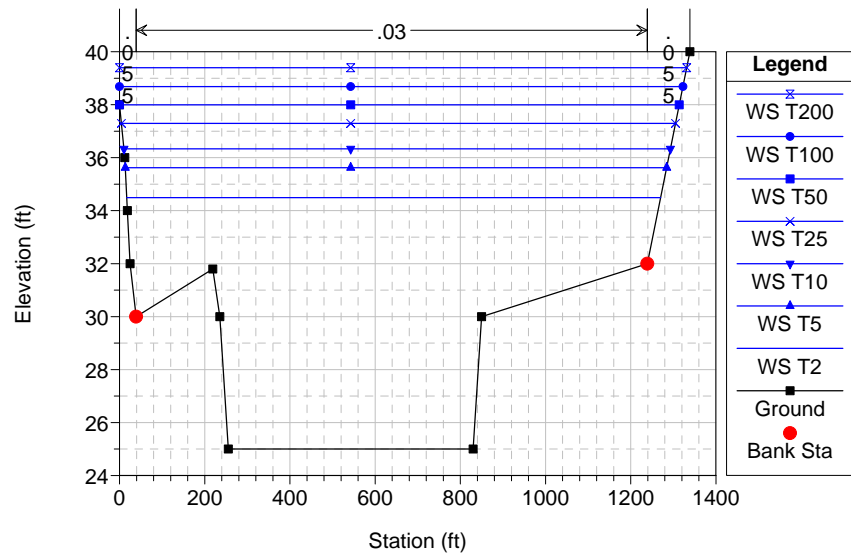

Tidal M1 Plan: Tidal M1 - Low tide 9/27/2006

River = Chilkat River Reach = 417+00 RS = .5 2-points added for typical average depth = 5-ft

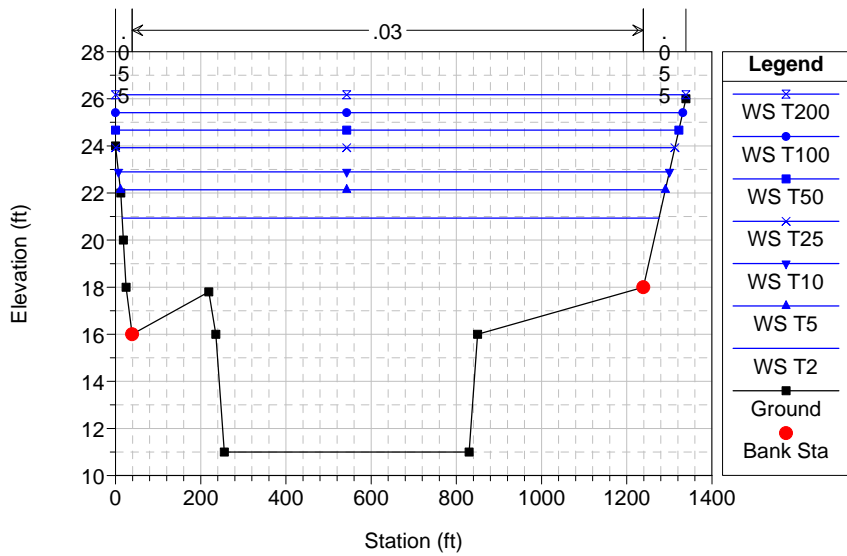

Tidal M1 Plan: Tidal M1 - Low tide 9/27/2006

River = Chilkat River Reach = 417+00 RS = .1 2-points added for typical average depth = 5-ft

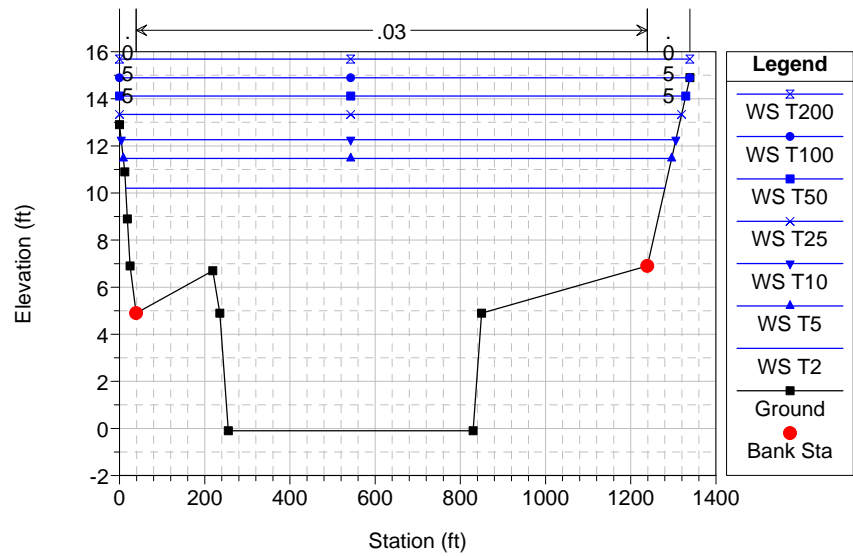

HEC-RAS Plan: TidalM1Lo River: Chilkat River Reach: 417+00

Reach	River Sta	Profile	Q Total (cfs)	Cum Ch Len (ft)	Min Ch El (ft)	W.S. Elev (ft)	Crit W.S. (ft)	E.G. Elev (ft)	E.G. Slope (ft/ft)	Max Chl Dpth (ft)	Hydr Depth C (ft)	Vel Chnl (ft/s)	Flow Area (sq ft)	Top Width (ft)	Top W Chnl (ft)	Froude # Chl	Shear Chan (lb/sq ft)
417+00	.1	T2	42300.00		-0.10	10.20	5.84	10.56	0.000664	10.30	7.31	4.80	8914.86	1265.64	1200.00	0.31	0.30
417+00	.1	T5	55300.00		-0.10	11.47	6.91	11.91	0.000664	11.57	8.57	5.34	10528.34	1287.01	1200.00	0.32	0.36
417+00	.1	T10	64200.00		-0.10	12.26	7.36	12.76	0.000664	12.36	9.37	5.67	11558.89	1301.94	1200.00	0.33	0.39
417+00	.1	T25	77100.00		-0.10	13.33	7.93	13.91	0.000665	13.43	10.44	6.10	12963.40	1319.31	1200.00	0.33	0.43
417+00	.1	T50	87100.00		-0.10	14.12	8.35	14.75	0.000664	14.22	11.22	6.40	14003.47	1329.13	1200.00	0.34	0.46
417+00	.1	T100	97500.00		-0.10	14.89	8.78	15.58	0.000664	14.99	12.00	6.69	15038.15	1338.83	1200.00	0.34	0.50
417+00	.1	T200	108700.00		-0.10	15.69	9.23	16.43	0.000664	15.79	12.79	6.98	16100.49	1338.90	1200.00	0.34	0.53
417+00	.5	T2	42300.00	14044.99	11.00	20.93		21.33	0.000790	9.93	6.94	5.06	8450.33	1259.98	1200.00	0.34	0.34
417+00	.5	T5	55300.00	14044.99	11.00	22.14		22.63	0.000789	11.14	8.14	5.63	9978.27	1278.97	1200.00	0.35	0.40
417+00	.5	T10	64200.00	14044.99	11.00	22.90		23.45	0.000789	11.90	8.90	5.97	10954.01	1293.20	1200.00	0.35	0.44
417+00	.5	T25	77100.00	14044.99	11.00	23.92		24.56	0.000788	12.92	9.93	6.42	12291.90	1312.45	1200.00	0.36	0.49
417+00	.5	T50	87100.00	14044.99	11.00	24.67		25.37	0.000787	13.67	10.68	6.73	13276.50	1322.28	1200.00	0.36	0.52
417+00	.5	T100	97500.00	14044.99	11.00	25.41		26.17	0.000786	14.41	11.42	7.04	14259.53	1331.54	1200.00	0.37	0.56
417+00	.5	T200	108700.00	14044.99	11.00	26.17		27.00	0.000785	15.17	12.18	7.34	15277.96	1338.90	1200.00	0.37	0.60
417+00	1	T2	42300.00	28279.06	25.00	34.49		34.95	0.000983	9.49	6.50	5.41	7898.19	1253.21	1200.00	0.37	0.40
417+00	1	T5	55300.00	28279.06	25.00	35.62		36.18	0.000983	10.62	7.63	6.01	9320.42	1270.57	1200.00	0.38	0.47
417+00	1	T10	64200.00	28279.06	25.00	36.33		36.96	0.000983	11.33	8.34	6.38	10226.35	1282.61	1200.00	0.39	0.51
417+00	1	T25	77100.00	28279.06	25.00	37.29		38.02	0.000982	12.29	9.30	6.86	11467.69	1300.63	1200.00	0.40	0.57
417+00	1	T50	87100.00	28279.06	25.00	37.99		38.79	0.000982	12.99	10.00	7.20	12382.67	1313.75	1200.00	0.40	0.61
417+00	1	T100	97500.00	28279.06	25.00	38.68		39.56	0.000982	13.68	10.69	7.52	13295.25	1322.45	1200.00	0.41	0.65
417+00	1	T200	108700.00	28279.06	25.00	39.40		40.34	0.000981	14.40	11.40	7.85	14241.21	1331.37	1200.00	0.41	0.70
417+00	2	T2	42300.00	28679.06	17.00	34.88		35.53	0.001835	17.88	5.39	6.52	6589.87	1246.25	1190.00	0.49	0.62
417+00	2	T5	55300.00	28679.06	17.00	35.98		36.75	0.001685	18.98	6.49	7.07	7972.23	1262.50	1190.00	0.49	0.68
417+00	2	T10	64200.00	28679.06	17.00	36.68		37.52	0.001617	19.68	7.19	7.41	8856.30	1275.86	1190.00	0.49	0.72
417+00	2	T25	77100.00	28679.06	17.00	37.62		38.57	0.001542	20.62	8.14	7.86	10071.71	1294.11	1190.00	0.49	0.78
417+00	2	T50	87100.00	28679.06	17.00	38.31		39.34	0.001498	21.31	8.83	8.18	10969.52	1310.02	1190.00	0.49	0.82
417+00	2	T100	97500.00	28679.06	17.00	39.00		40.10	0.001462	22.00	9.51	8.49	11870.48	1328.87	1190.00	0.49	0.87
417+00	2	T200	108700.00	28679.06	17.00	39.70		40.89	0.001428	22.70	10.21	8.80	12813.35	1348.31	1190.00	0.49	0.91
417+00	3	T2	42300.00	28954.06	22.00	35.45		35.93	0.001094	13.45	6.29	5.58	7716.34	1261.50	1190.00	0.39	0.43
417+00	3	T5	55300.00	28954.06	22.00	36.54		37.14	0.001095	14.54	7.38	6.21	9099.48	1277.21	1190.00	0.40	0.50
417+00	3	T10	64200.00	28954.06	22.00	37.23		37.90	0.001093	15.23	8.07	6.59	9986.54	1287.18	1190.00	0.41	0.55
417+00	3	T25	77100.00	28954.06	22.00	38.17		38.94	0.001089	16.17	9.01	7.08	11203.05	1300.72	1190.00	0.42	0.61
417+00	3	T50	87100.00	28954.06	22.00	38.86		39.71	0.001085	16.86	9.70	7.42	12100.49	1310.66	1190.00	0.42	0.66
417+00	3	T100	97500.00	28954.06	22.00	39.54		40.46	0.001082	17.54	10.38	7.75	12996.76	1320.50	1190.00	0.42	0.70
417+00	3	T200	108700.00	28954.06	22.00	40.25		41.24	0.001079	18.25	11.08	8.09	13927.56	1327.10	1190.00	0.43	0.75
417+00	4	T2	42300.00	29284.06	26.00	35.81		36.37	0.001425	9.81	5.81	6.04	7160.78	1265.78	1184.00	0.44	0.52
417+00	4	T5	55300.00	29284.06	26.00	36.89		37.57	0.001377	10.89	6.89	6.65	8536.97	1282.71	1184.00	0.45	0.59
417+00	4	T10	64200.00	29284.06	26.00	37.57		38.33	0.001350	11.57	7.58	7.02	9420.53	1293.62	1184.00	0.45	0.64
417+00	4	T25	77100.00	29284.06	26.00	38.51		39.36	0.001321	12.51	8.51	7.50	10634.26	1312.96	1184.00	0.45	0.70
417+00	4	T50	87100.00	29284.06	26.00	39.19		40.13	0.001303	13.19	9.19	7.84	11534.99	1329.90	1184.00	0.46	0.75
417+00	4	T100	97500.00	29284.06	26.00	39.86		40.88	0.001286	13.86	9.87	8.17	12440.35	1346.71	1184.00	0.46	0.79
417+00	4	T200	108700.00	29284.06	26.00	40.56		41.66	0.001267	14.56	10.57	8.49	13384.57	1350.10	1184.00	0.46	0.84

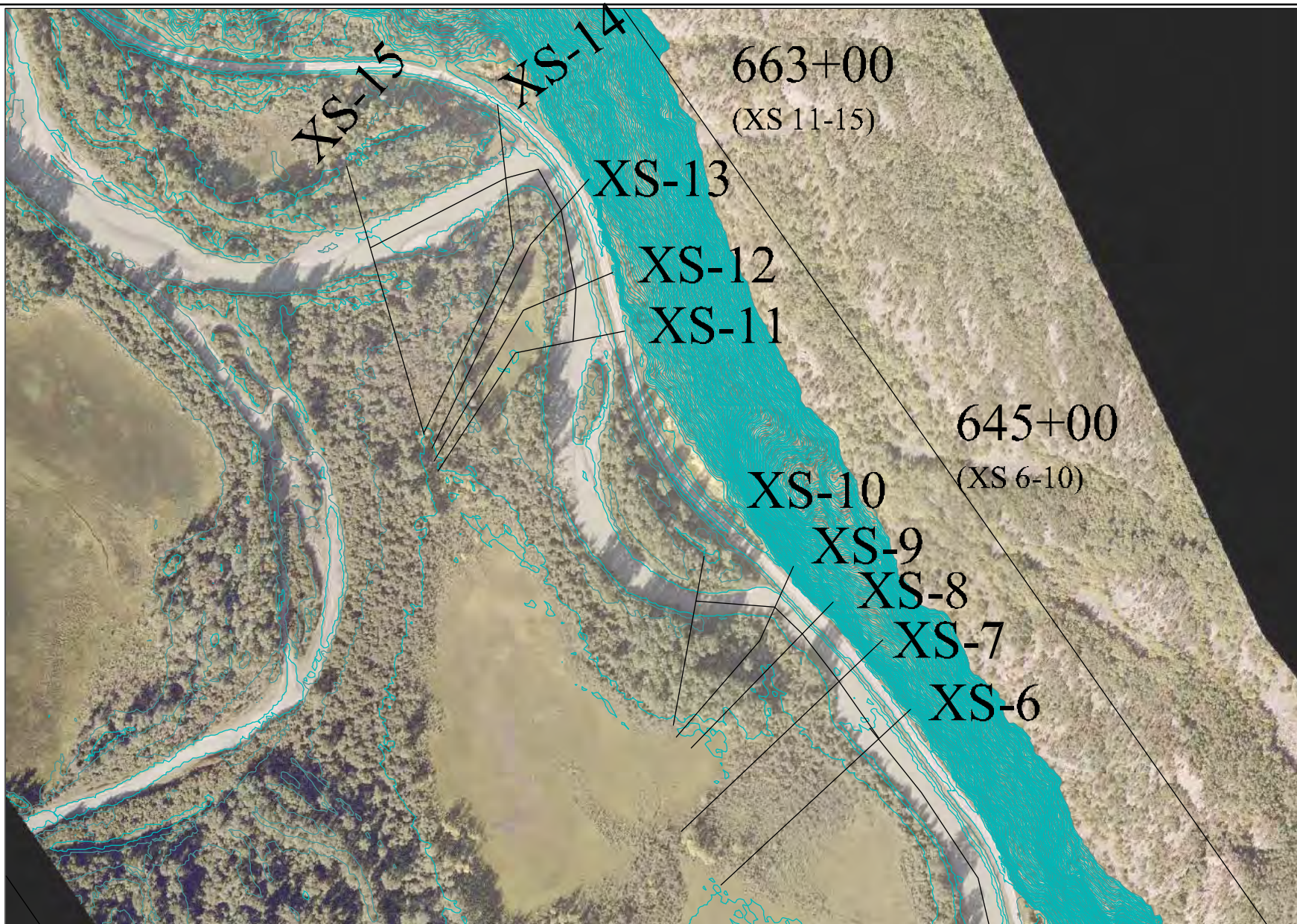

663+00
(XS 11-15)

XS-13

XS-12

XS-11

645+00
(XS 6-10)

XS-10

XS-9

XS-8

XS-7

XS-6

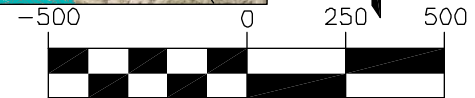

1 inch = 500ft.

Haines Highway – HEC-RAS Schematic

S&HI Stations 645+00 and 663+00

645 Plan: 645 - Existing 11/15/2005
RS = 10 Add/move points for estimated 2-ft depth along glide/riffle

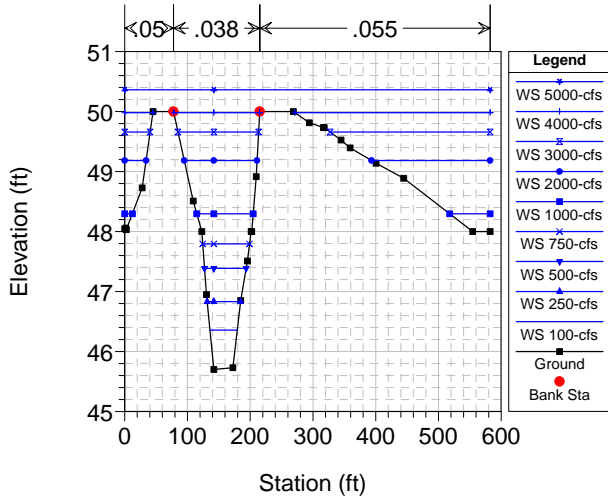

645 Plan: 645 - Existing 11/15/2005
RS = 9 Add 7 points to approx 9.5-ft scour

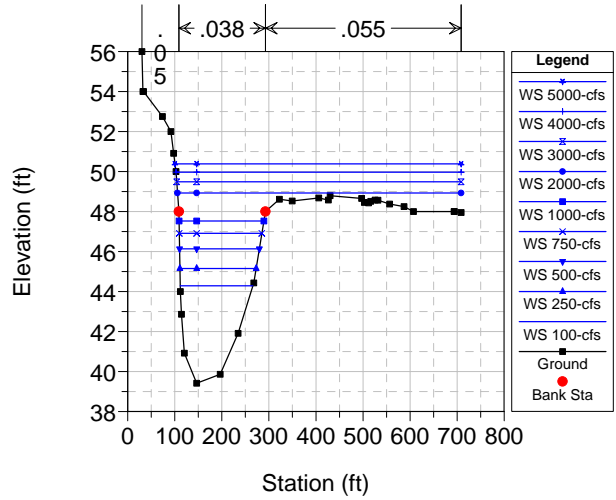

645 Plan: 645 - Existing 11/15/2005
RS = 8 Add 7 points to approx 7-ft scour

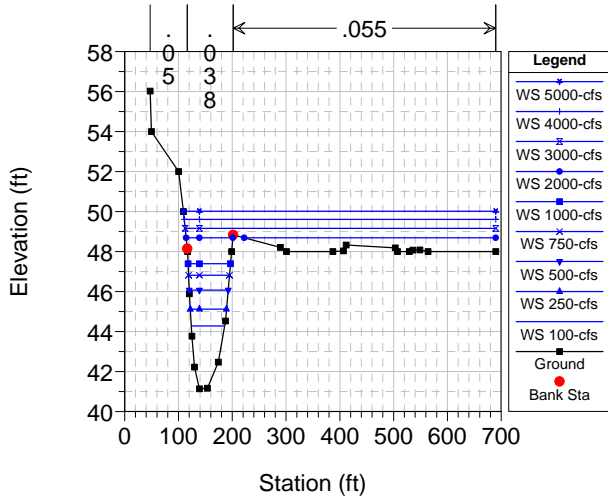

645 Plan: 645 - Existing 11/15/2005
RS = 7 moved two points for 3-ft depth

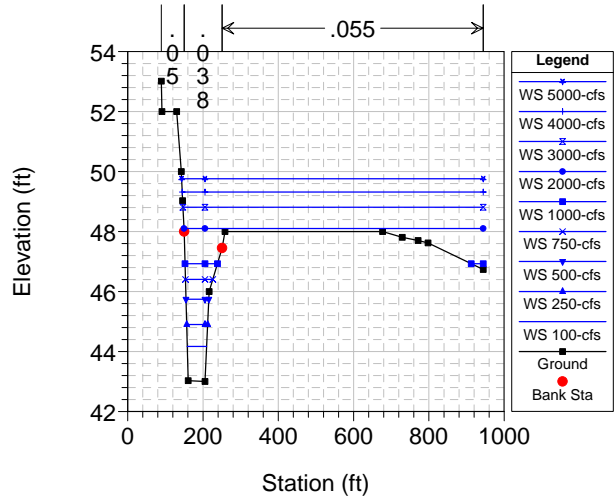

645 Plan: 645 - Existing 11/15/2005
RS = 6 Add two points for 3-ft depth

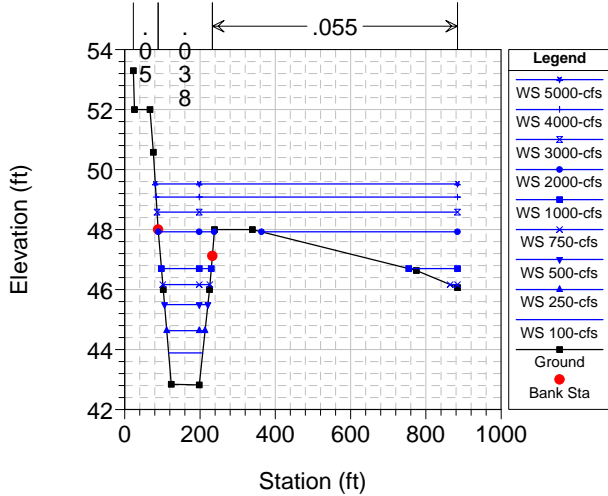

HEC-RAS Plan: 645 River: Chilkat Reach: 645+00

Reach	River Sta	Profile	Q Total (cfs)	Cum Ch Len (ft)	Min Ch El (ft)	W.S. Elev (ft)	Crit W.S. (ft)	E.G. Elev (ft)	E.G. Slope (ft/ft)	Max Chl Dpth (ft)	Hydr Depth C (ft)	Vel Chnl (ft/s)	Flow Area (sq ft)	Top Width (ft)	Top W Chnl (ft)	Froude # Chl	Shear Chan (lb/sq ft)
645+00	6	100-cfs	100.00		42.82	43.89	43.21	43.91	0.000901	1.07	0.96	1.14	87.39	90.61	90.61	0.21	0.05
645+00	6	250-cfs	250.00		42.82	44.63	43.52	44.67	0.000901	1.81	1.56	1.57	158.75	101.94	101.94	0.22	0.09
645+00	6	500-cfs	500.00		42.82	45.50	43.90	45.56	0.000901	2.68	2.19	1.98	252.78	115.18	115.18	0.24	0.12
645+00	6	750-cfs	750.00		42.82	46.17	44.22	46.24	0.000901	3.35	2.66	2.25	334.36	144.77	125.15	0.24	0.15
645+00	6	1000-cfs	1000.00		42.82	46.70	44.50	46.79	0.000902	3.88	3.03	2.45	440.47	261.92	132.42	0.25	0.17
645+00	6	2000-cfs	2000.00		42.82	47.92	45.39	48.04	0.000901	5.10	3.98	2.94	1012.20	669.79	143.67	0.26	0.22
645+00	6	3000-cfs	3000.00		42.82	48.58	46.11	48.70	0.000901	5.76	4.62	3.25	1525.76	798.19	144.18	0.27	0.26
645+00	6	4000-cfs	4000.00		42.82	49.08	47.04	49.21	0.000901	6.26	5.13	3.48	1926.51	800.62	144.18	0.27	0.29
645+00	6	5000-cfs	5000.00		42.82	49.52	47.62	49.66	0.000900	6.70	5.57	3.67	2279.87	802.76	144.18	0.27	0.31
645+00	7	100-cfs	100.00	236.00	43.00	44.17		44.22	0.001945	1.17	1.08	1.80	55.43	51.40	51.40	0.31	0.13
645+00	7	250-cfs	250.00	236.00	43.00	44.90		45.01	0.002282	1.90	1.70	2.64	94.69	55.68	55.68	0.36	0.24
645+00	7	500-cfs	500.00	236.00	43.00	45.74		45.93	0.002566	2.74	2.37	3.48	143.53	60.58	60.58	0.40	0.37
645+00	7	750-cfs	750.00	236.00	43.00	46.40		46.65	0.003067	3.40	2.57	4.02	186.45	72.49	72.49	0.44	0.48
645+00	7	1000-cfs	1000.00	236.00	43.00	46.93		47.23	0.003490	3.93	2.65	4.38	231.11	117.87	86.05	0.47	0.57
645+00	7	2000-cfs	2000.00	236.00	43.00	48.10		48.51	0.003772	5.10	3.39	5.37	558.59	794.66	100.79	0.51	0.79
645+00	7	3000-cfs	3000.00	236.00	43.00	48.81		49.07	0.002473	5.81	4.10	4.93	1122.16	797.56	100.79	0.43	0.62
645+00	7	4000-cfs	4000.00	236.00	43.00	49.32		49.55	0.002071	6.32	4.61	4.88	1529.81	799.51	100.79	0.40	0.59
645+00	7	5000-cfs	5000.00	236.00	43.00	49.76		49.97	0.001852	6.76	5.05	4.90	1883.74	801.09	100.79	0.38	0.58
645+00	8	100-cfs	100.00	440.00	41.14	44.28		44.29	0.000122	3.14	2.21	0.73	136.98	61.85	61.85	0.09	0.02
645+00	8	250-cfs	250.00	440.00	41.14	45.12		45.14	0.000282	3.98	2.84	1.31	191.40	67.36	67.36	0.14	0.05
645+00	8	500-cfs	500.00	440.00	41.14	46.07		46.13	0.000462	4.93	3.56	1.94	258.15	72.56	72.56	0.18	0.10
645+00	8	750-cfs	750.00	440.00	41.14	46.81		46.90	0.000584	5.67	4.12	2.39	313.24	76.10	76.10	0.21	0.15
645+00	8	1000-cfs	1000.00	440.00	41.14	47.39		47.52	0.000698	6.25	4.54	2.79	358.30	78.88	78.88	0.23	0.19
645+00	8	2000-cfs	2000.00	440.00	41.14	48.68		48.91	0.001105	7.54	5.46	3.96	726.58	554.68	84.94	0.30	0.37
645+00	8	3000-cfs	3000.00	440.00	41.14	49.16		49.47	0.001521	8.02	5.91	4.90	1001.40	577.63	85.50	0.36	0.55
645+00	8	4000-cfs	4000.00	440.00	41.14	49.61		49.96	0.001721	8.47	6.35	5.47	1259.50	579.36	85.50	0.38	0.67
645+00	8	5000-cfs	5000.00	440.00	41.14	50.01		50.39	0.001837	8.87	6.76	5.89	1493.68	580.93	85.50	0.40	0.76
645+00	9	100-cfs	100.00	570.00	39.42	44.29		44.29	0.000005	4.87	3.39	0.19	523.85	154.33	154.33	0.02	0.00
645+00	9	250-cfs	250.00	570.00	39.42	45.15		45.15	0.000015	5.73	4.08	0.38	660.19	161.87	161.87	0.03	0.00
645+00	9	500-cfs	500.00	570.00	39.42	46.14		46.14	0.000030	6.72	4.86	0.61	824.09	169.52	169.52	0.05	0.01
645+00	9	750-cfs	750.00	570.00	39.42	46.91		46.92	0.000042	7.49	5.46	0.78	957.73	175.51	175.51	0.06	0.01
645+00	9	1000-cfs	1000.00	570.00	39.42	47.53		47.54	0.000055	8.11	5.92	0.94	1067.29	180.27	180.27	0.07	0.02
645+00	9	2000-cfs	2000.00	570.00	39.42	48.93		48.96	0.000105	9.51	7.20	1.48	1546.00	602.69	183.91	0.10	0.05
645+00	9	3000-cfs	3000.00	570.00	39.42	49.49		49.55	0.000171	10.07	7.76	1.98	1885.56	604.41	183.91	0.13	0.08
645+00	9	4000-cfs	4000.00	570.00	39.42	49.97		50.05	0.000231	10.55	8.24	2.40	2175.78	605.88	183.91	0.15	0.12
645+00	9	5000-cfs	5000.00	570.00	39.42	50.39		50.49	0.000287	10.97	8.66	2.76	2430.04	608.08	183.91	0.17	0.15
645+00	10	100-cfs	100.00	838.00	45.70	46.36	46.36	46.63	0.026149	0.66	0.55	4.22	23.71	43.47	43.47	1.01	0.89
645+00	10	250-cfs	250.00	838.00	45.70	46.83	46.83	47.28	0.022378	1.13	0.88	5.36	46.68	53.18	53.18	1.01	1.22
645+00	10	500-cfs	500.00	838.00	45.70	47.39	47.39	48.00	0.020146	1.69	1.20	6.27	79.75	66.26	66.26	1.01	1.51
645+00	10	750-cfs	750.00	838.00	45.70	47.79	47.79	48.54	0.018992	2.09	1.46	6.91	108.58	74.61	74.61	1.01	1.72
645+00	10	1000-cfs	1000.00	838.00	45.70	48.30	48.30	48.96	0.014408	2.60	1.66	6.57	165.05	166.57	89.98	0.90	1.49
645+00	10	2000-cfs	2000.00	838.00	45.70	49.18	49.18	49.82	0.011832	3.48	2.08	6.92	387.97	339.08	116.06	0.85	1.53
645+00	10	3000-cfs	3000.00	838.00	45.70	49.66	49.66	50.34	0.011885	3.96	2.33	7.48	569.99	423.86	128.42	0.86	1.73
645+00	10	4000-cfs	4000.00	838.00	45.70	49.98	49.98	50.75	0.012843	4.28	2.50	8.15	718.85	492.86	136.85	0.91	2.00
645+00	10	5000-cfs	5000.00	838.00	45.70	50.36	50.36	51.10	0.010787	4.66	2.88	8.19	939.47	582.35	137.32	0.85	1.93

663 Plan: 663 Lidar w soundings 11/16/2005
 RS = 15 adjust from toe of bank to 2-ft depth

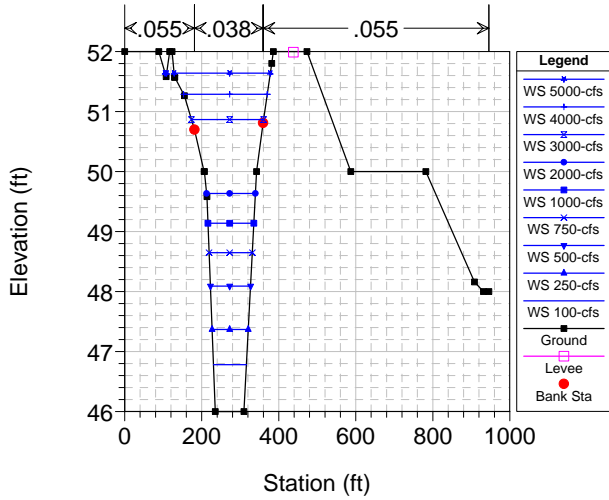

663 Plan: 663 Lidar w soundings 11/16/2005
 RS = 14 Depth sounder readings (to -15' from left bank) included, XS app

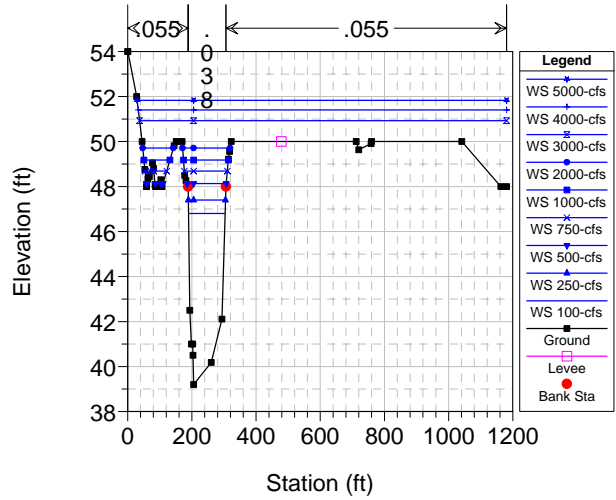

663 Plan: 663 Lidar w soundings 11/16/2005
 RS = 13 Depth sounder readings (to -15' from left bank) included, XS app

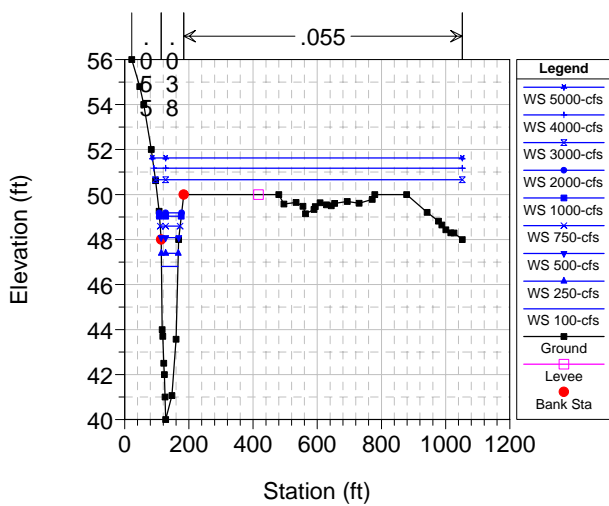

663 Plan: 663 Lidar w soundings 11/16/2005
 RS = 12 Depth sounder readings (to -15' from left bank) included, XS app

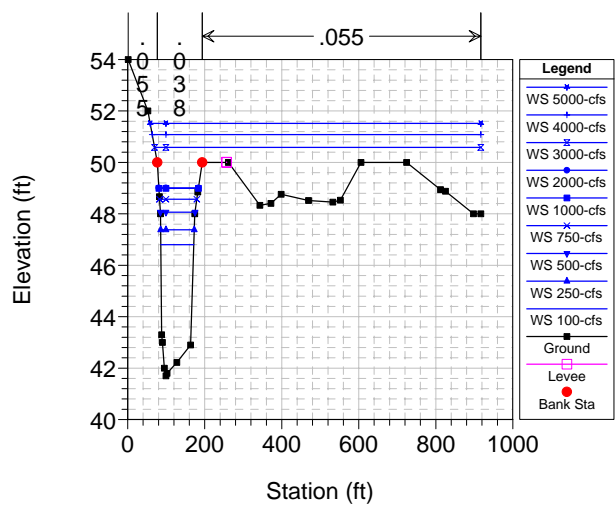

663 Plan: 663 Lidar w soundings 11/16/2005
 RS = 11 add two points for 2-ft depth at riffle

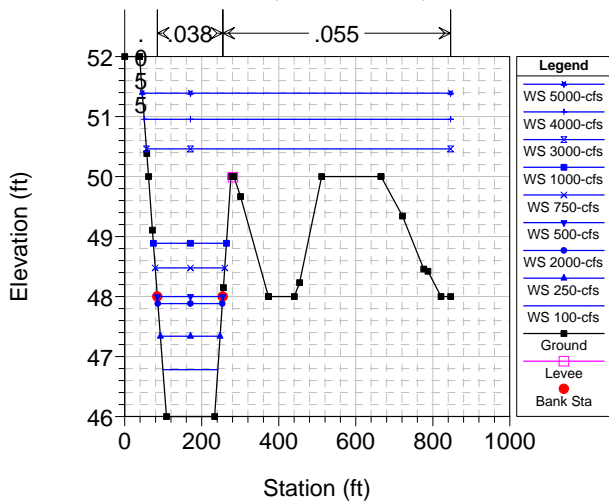

HEC-RAS Plan: 663 w sndgs River: Chilkat Reach: 663+00

Reach	River Sta	Profile	Q Total (cfs)	Cum Ch Len (ft)	Min Ch El (ft)	W.S. Elev (ft)	Crit W.S. (ft)	E.G. Elev (ft)	E.G. Slope (ft/ft)	Max Chl Dpth (ft)	Hydr Depth C (ft)	Vel Chnl (ft/s)	Flow Area (sq ft)	Top Width (ft)	Top W Chnl (ft)	Froude # Chl	Shear Chan (lb/sq ft)
663+00	11	100-cfs	100.00		46.00	46.78	46.27	46.80	0.000902	0.78	0.73	0.95	104.71	142.68	142.68	0.20	0.04
663+00	11	250-cfs	250.00		46.00	47.34	46.49	47.37	0.000901	1.34	1.21	1.33	187.74	155.22	155.22	0.21	0.07
663+00	11	500-cfs	500.00		46.00	48.00	46.77	48.04	0.000900	2.00	1.74	1.69	295.24	170.09	170.08	0.23	0.10
663+00	11	750-cfs	750.00		46.00	48.48	47.00	48.54	0.000901	2.48	2.21	1.99	378.79	180.77	170.08	0.24	0.12
663+00	11	1000-cfs	1000.00		46.00	48.89	47.21	48.97	0.000900	2.89	2.62	2.23	455.22	190.00	170.08	0.24	0.15
663+00	11	2000-cfs	2000.00		46.00	47.88	47.88	48.70	0.017813	1.88	1.64	7.27	275.28	167.43	167.43	1.00	1.83
663+00	11	3000-cfs	3000.00		46.00	50.46	48.40	50.57	0.000900	4.46	4.20	3.05	1548.17	790.02	170.08	0.26	0.24
663+00	11	4000-cfs	4000.00		46.00	50.95	48.87	51.07	0.000901	4.95	4.69	3.29	1939.03	795.70	170.08	0.27	0.26
663+00	11	5000-cfs	5000.00		46.00	51.39	49.29	51.52	0.000900	5.39	5.13	3.49	2286.53	800.71	170.08	0.27	0.29
663+00	12	100-cfs	100.00	181.00	41.70	46.80	42.61	46.80	0.000008	5.10	4.17	0.28	357.17	85.69	85.69	0.02	0.00
663+00	12	250-cfs	250.00	181.00	41.70	47.38	43.01	47.39	0.000033	5.68	4.67	0.61	407.26	87.29	87.29	0.05	0.01
663+00	12	500-cfs	500.00	181.00	41.70	48.07	43.43	48.08	0.000088	6.37	5.20	1.07	467.86	89.93	89.93	0.08	0.03
663+00	12	750-cfs	750.00	181.00	41.70	48.57	43.78	48.60	0.000158	6.87	5.31	1.46	514.39	96.88	96.88	0.11	0.05
663+00	12	1000-cfs	1000.00	181.00	41.70	48.99	44.08	49.04	0.000233	7.29	5.42	1.80	557.08	102.74	102.74	0.14	0.08
663+00	12	2000-cfs	2000.00	181.00	41.70	49.01	45.10	49.21	0.000925	7.31	5.43	3.58	558.80	102.98	102.98	0.27	0.30
663+00	12	3000-cfs	3000.00	181.00	41.70	50.59	45.96	50.69	0.000515	8.89	6.30	2.96	1787.24	847.03	116.85	0.21	0.20
663+00	12	4000-cfs	4000.00	181.00	41.70	51.08	46.71	51.19	0.000567	9.38	6.79	3.26	2207.90	853.06	116.85	0.22	0.23
663+00	12	5000-cfs	5000.00	181.00	41.70	51.52	47.38	51.64	0.000602	9.82	7.23	3.50	2582.39	858.39	116.85	0.23	0.26
663+00	13	100-cfs	100.00	450.00	40.00	46.80	41.42	46.81	0.000015	6.80	4.72	0.42	240.90	51.03	51.03	0.03	0.00
663+00	13	250-cfs	250.00	450.00	40.00	47.39	42.14	47.40	0.000068	7.39	5.17	0.92	271.15	52.47	52.47	0.07	0.02
663+00	13	500-cfs	500.00	450.00	40.00	48.08	42.96	48.12	0.000189	8.08	5.64	1.62	308.32	55.11	54.66	0.12	0.06
663+00	13	750-cfs	750.00	450.00	40.00	48.59	43.58	48.67	0.000346	8.59	5.74	2.22	338.23	61.97	58.78	0.16	0.12
663+00	13	1000-cfs	1000.00	450.00	40.00	49.04	44.08	49.15	0.000512	9.04	5.84	2.74	366.83	67.89	62.34	0.20	0.17
663+00	13	2000-cfs	2000.00	450.00	40.00	49.19	45.60	49.63	0.001926	9.19	5.88	5.35	377.17	69.91	63.55	0.39	0.66
663+00	13	3000-cfs	3000.00	450.00	40.00	50.66	46.84	50.90	0.001160	10.66	6.76	4.57	1372.13	956.19	70.12	0.31	0.46
663+00	13	4000-cfs	4000.00	450.00	40.00	51.17	47.91	51.39	0.001106	11.17	7.28	4.69	1866.31	961.31	70.12	0.31	0.47
663+00	13	5000-cfs	5000.00	450.00	40.00	51.62	49.10	51.82	0.001057	11.62	7.73	4.77	2299.87	965.79	70.12	0.30	0.48
663+00	14	100-cfs	100.00	724.00	39.20	46.81	40.15	46.81	0.000001	7.61	5.96	0.15	678.98	114.01	114.01	0.01	0.00
663+00	14	250-cfs	250.00	724.00	39.20	47.40	40.55	47.41	0.000006	8.20	6.46	0.33	747.67	115.83	115.83	0.02	0.00
663+00	14	500-cfs	500.00	724.00	39.20	48.13	41.06	48.14	0.000018	8.93	7.08	0.60	836.15	147.28	117.64	0.04	0.01
663+00	14	750-cfs	750.00	724.00	39.20	48.69	41.42	48.70	0.000032	9.49	7.63	0.83	930.93	191.32	117.64	0.05	0.01
663+00	14	1000-cfs	1000.00	724.00	39.20	49.18	41.73	49.19	0.000045	9.98	8.12	1.03	1031.68	220.24	117.64	0.06	0.02
663+00	14	2000-cfs	2000.00	724.00	39.20	49.71	42.66	49.76	0.000142	10.51	8.66	1.92	1155.19	243.29	117.64	0.11	0.07
663+00	14	3000-cfs	3000.00	724.00	39.20	50.93	43.40	50.99	0.000149	11.73	9.88	2.14	2456.52	1143.35	117.64	0.12	0.09
663+00	14	4000-cfs	4000.00	724.00	39.20	51.41	44.03	51.48	0.000189	12.21	10.35	2.49	3002.37	1147.44	117.64	0.14	0.12
663+00	14	5000-cfs	5000.00	724.00	39.20	51.83	44.62	51.92	0.000221	12.63	10.78	2.77	3487.66	1151.06	117.64	0.15	0.14
663+00	15	100-cfs	100.00	1238.00	46.00	46.78	46.38	46.82	0.002558	0.78	0.73	1.60	62.41	85.50	85.50	0.33	0.12
663+00	15	250-cfs	250.00	1238.00	46.00	47.37	46.69	47.44	0.002369	1.37	1.22	2.18	114.94	93.88	93.88	0.35	0.18
663+00	15	500-cfs	500.00	1238.00	46.00	48.09	47.08	48.20	0.002162	2.09	1.79	2.68	186.78	104.27	104.27	0.35	0.24
663+00	15	750-cfs	750.00	1238.00	46.00	48.65	47.41	48.79	0.002119	2.65	2.20	3.04	246.87	112.22	112.22	0.36	0.29
663+00	15	1000-cfs	1000.00	1238.00	46.00	49.14	47.68	49.31	0.002046	3.14	2.55	3.29	303.87	119.27	119.27	0.36	0.32
663+00	15	2000-cfs	2000.00	1238.00	46.00	49.63	48.59	50.10	0.004841	3.63	2.87	5.49	364.61	126.85	126.85	0.57	0.87
663+00	15	3000-cfs	3000.00	1238.00	46.00	50.87	49.31	51.33	0.004311	4.87	3.09	5.44	552.40	187.47	178.43	0.54	0.83
663+00	15	4000-cfs	4000.00	1238.00	46.00	51.29	49.95	51.92	0.004989	5.29	3.51	6.37	637.33	217.08	178.43	0.60	1.09
663+00	15	5000-cfs	5000.00	1238.00	46.00	51.64	50.64	52.44	0.005609	5.64	3.87	7.20	720.44	253.85	178.43	0.65	1.35

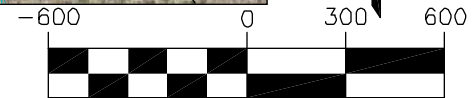
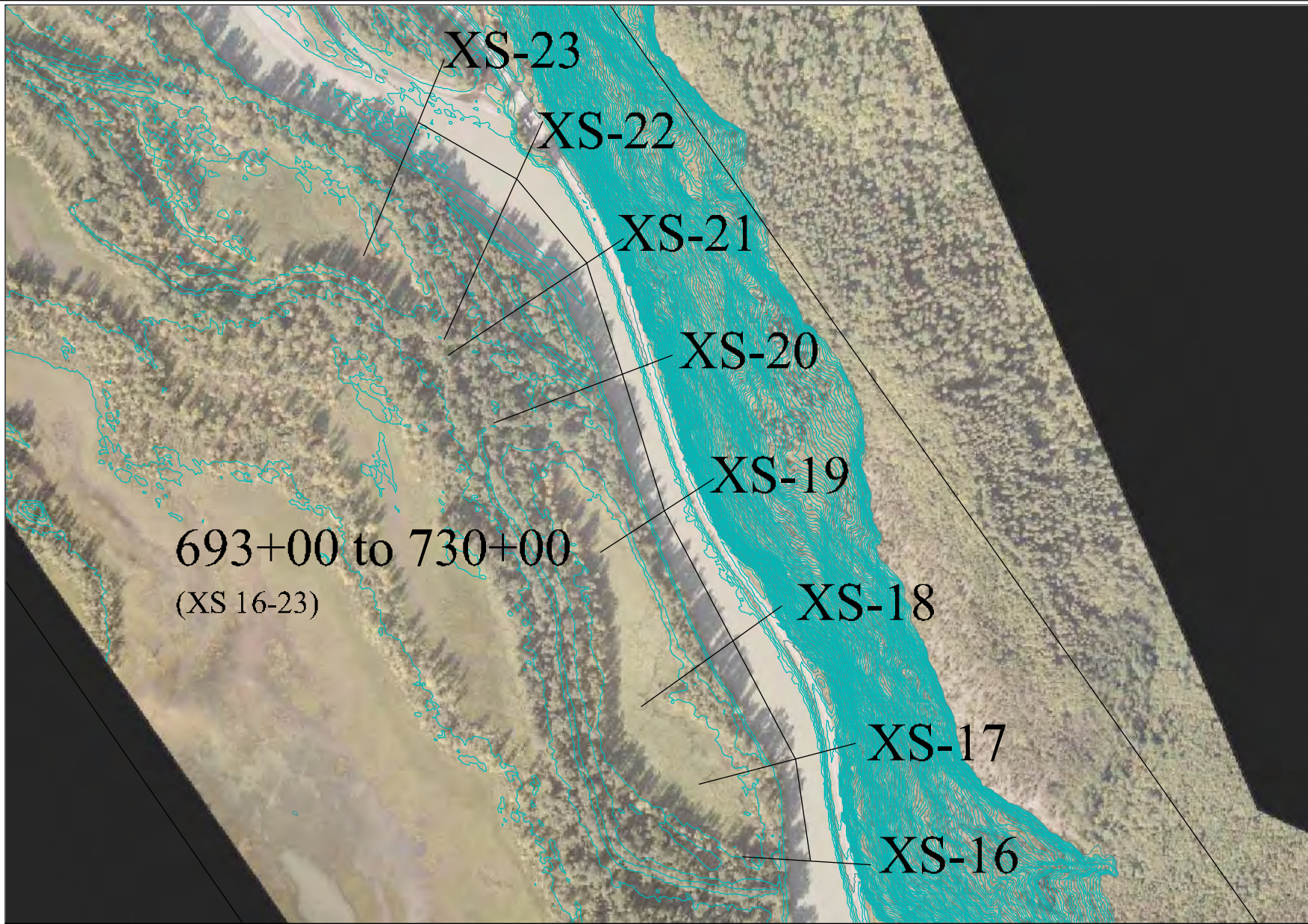

1 inch = 600ft.



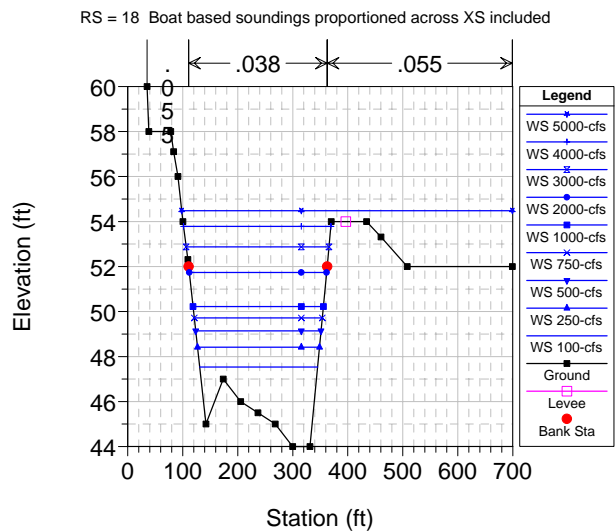
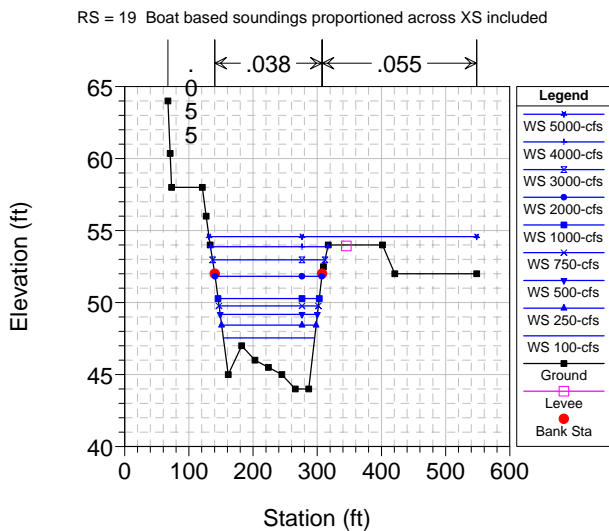
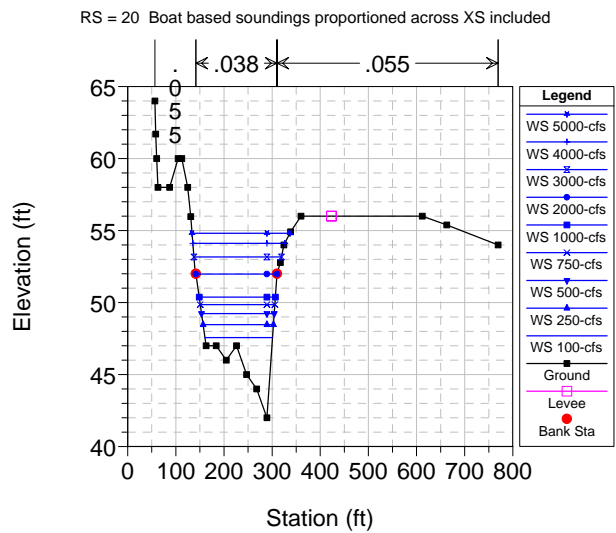
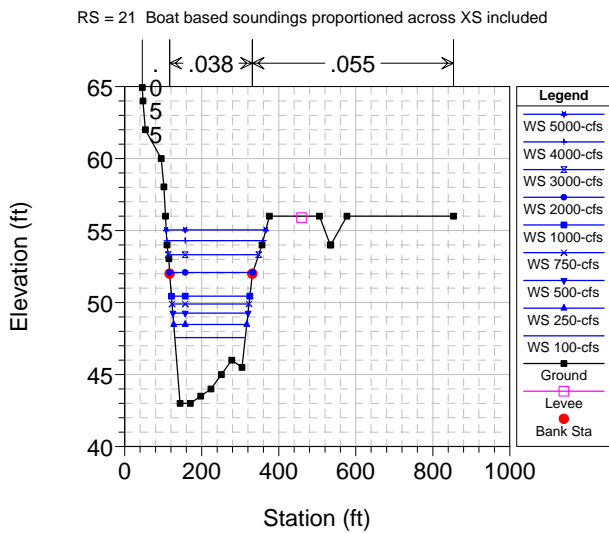
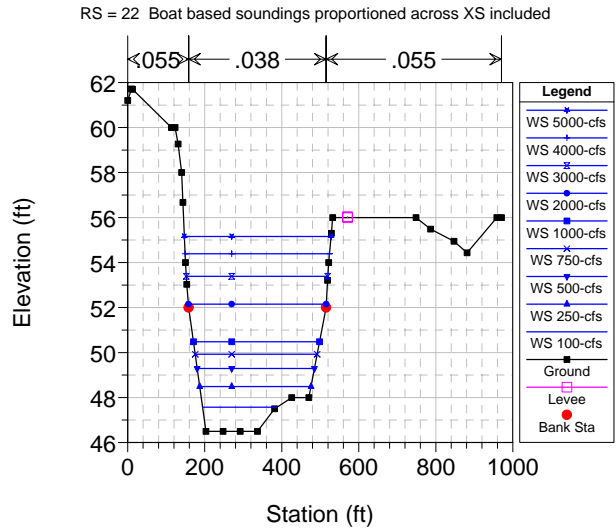
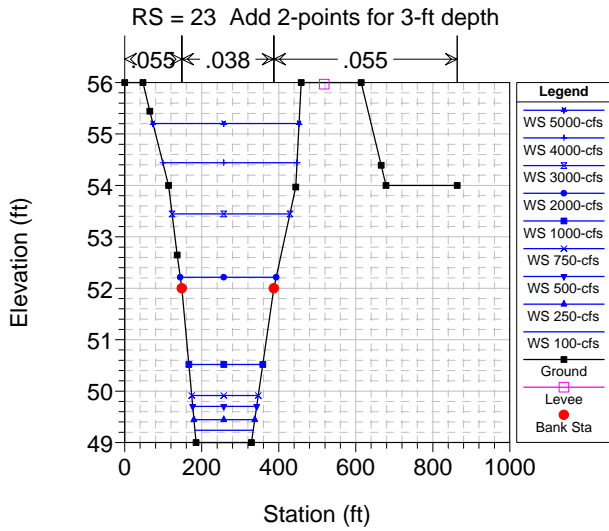

693-730+00 Plan: 700+00 LIDAR w. Soundings 11/16/2005

RS = 17 Boat based soundings proportioned across XS included

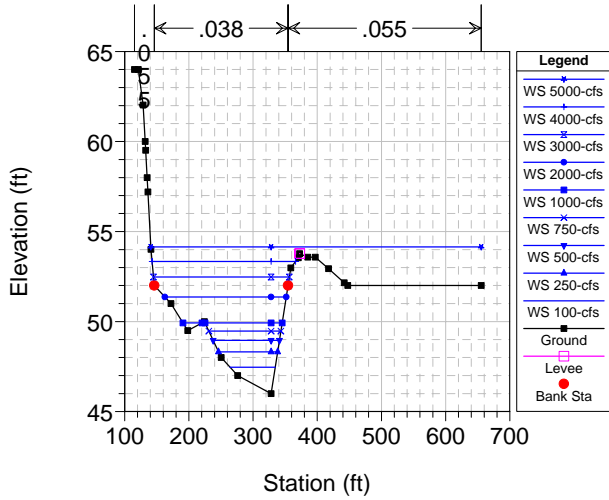

693-730+00 Plan: 700+00 LIDAR w. Soundings 11/16/2005

RS = 16 Boat based soundings proportioned across XS included

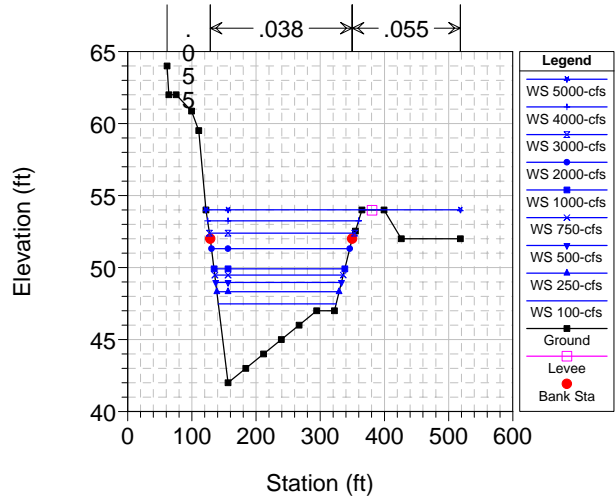

693-730+00 Plan: 700+00 LIDAR w. Soundings 11/16/2005

RS = 15.5 Boat based soundings proportioned across XS included

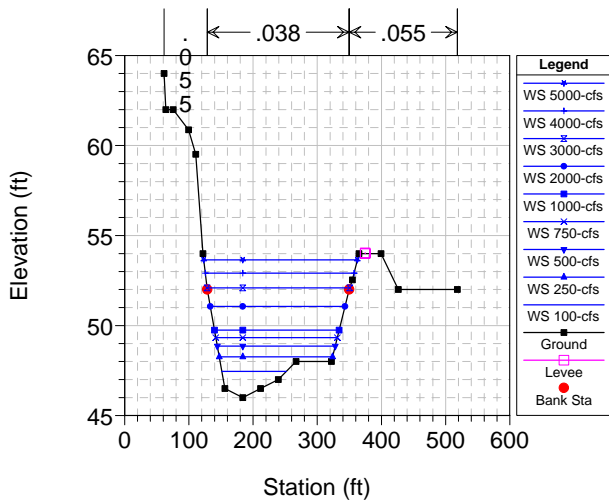

HEC-RAS Plan: 700 bathym River: Chilkat Reach: 700+00

Reach	River Sta	Profile	Q Total (cfs)	Cum Ch Len (ft)	Min Ch El (ft)	W.S. Elev (ft)	Crit W.S. (ft)	E.G. Elev (ft)	E.G. Slope (ft/ft)	Max Chl Dpth (ft)	Hydr Depth C (ft)	Vel Chnl (ft/s)	Flow Area (sq ft)	Top Width (ft)	Top W Chnl (ft)	Froude # Chl	Shear Chan (lb/sq ft)
700+00	15.5	100-cfs	100.00		46.00	47.45	46.73	47.47	0.000901	1.45	0.91	1.10	91.02	100.41	100.41	0.20	0.05
700+00	15.5	250-cfs	250.00		46.00	48.27	47.07	48.29	0.000901	2.27	1.12	1.26	197.73	176.59	176.59	0.21	0.06
700+00	15.5	500-cfs	500.00		46.00	48.86	47.46	48.90	0.000901	2.86	1.66	1.64	304.45	183.63	183.63	0.22	0.09
700+00	15.5	750-cfs	750.00		46.00	49.33	47.76	49.39	0.000901	3.33	2.08	1.91	393.07	189.28	189.28	0.23	0.12
700+00	15.5	1000-cfs	1000.00		46.00	49.75	48.14	49.82	0.000900	3.75	2.43	2.12	472.14	194.18	194.18	0.24	0.14
700+00	15.5	2000-cfs	2000.00		46.00	51.06	48.74	51.18	0.000901	5.06	3.52	2.71	738.19	209.84	209.84	0.25	0.20
700+00	15.5	3000-cfs	3000.00		46.00	52.10	49.23	52.25	0.000901	6.10	4.35	3.12	961.45	222.21	220.98	0.26	0.24
700+00	15.5	4000-cfs	4000.00		46.00	52.91	49.68	53.10	0.000902	6.91	5.17	3.50	1147.13	231.74	220.98	0.27	0.29
700+00	15.5	5000-cfs	5000.00		46.00	53.65	50.07	53.88	0.000901	7.65	5.90	3.82	1320.59	239.36	220.98	0.28	0.33
700+00	16	100-cfs	100.00	500.00	42.00	47.48	43.22	47.48	0.000009	5.48	2.55	0.21	467.46	183.54	183.54	0.02	0.00
700+00	16	250-cfs	250.00	500.00	42.00	48.32	43.76	48.32	0.000022	6.32	3.28	0.40	624.39	190.49	190.49	0.04	0.00
700+00	16	500-cfs	500.00	500.00	42.00	48.96	44.32	48.97	0.000049	6.96	3.82	0.67	747.76	195.79	195.79	0.06	0.01
700+00	16	750-cfs	750.00	500.00	42.00	49.47	44.73	49.48	0.000075	7.47	4.24	0.88	848.93	200.03	200.03	0.08	0.02
700+00	16	1000-cfs	1000.00	500.00	42.00	49.91	45.07	49.93	0.000098	7.91	4.61	1.07	938.00	203.68	203.68	0.09	0.03
700+00	16	2000-cfs	2000.00	500.00	42.00	51.31	46.04	51.35	0.000171	9.31	5.72	1.63	1230.35	215.25	215.25	0.12	0.06
700+00	16	3000-cfs	3000.00	500.00	42.00	52.39	46.75	52.45	0.000222	10.39	6.64	2.04	1468.05	225.96	220.98	0.14	0.09
700+00	16	4000-cfs	4000.00	500.00	42.00	53.25	47.39	53.34	0.000263	11.25	7.49	2.41	1665.44	235.17	220.98	0.16	0.12
700+00	16	5000-cfs	5000.00	500.00	42.00	54.01	47.79	54.12	0.000283	12.01	8.26	2.67	2061.60	396.15	220.98	0.16	0.14
700+00	17	100-cfs	100.00	917.00	46.00	47.46	46.95	47.51	0.002580	1.46	0.82	1.74	57.64	70.41	70.41	0.34	0.13
700+00	17	250-cfs	250.00	917.00	46.00	48.31	47.37	48.37	0.001634	2.31	1.39	1.96	127.53	92.02	92.02	0.29	0.14
700+00	17	500-cfs	500.00	917.00	46.00	48.95	47.84	49.06	0.002014	2.95	1.84	2.63	190.09	103.20	103.20	0.34	0.23
700+00	17	750-cfs	750.00	917.00	46.00	49.47	48.18	49.61	0.002156	3.47	2.19	3.05	245.66	112.20	112.20	0.36	0.29
700+00	17	1000-cfs	1000.00	917.00	46.00	49.93	48.48	50.09	0.002736	3.93	2.04	3.28	304.99	149.72	149.72	0.40	0.35
700+00	17	2000-cfs	2000.00	917.00	46.00	51.37	49.42	51.57	0.002082	5.37	2.91	3.63	551.09	189.24	189.24	0.37	0.38
700+00	17	3000-cfs	3000.00	917.00	46.00	52.47	50.25	52.70	0.001708	6.47	3.72	3.87	776.13	211.74	208.47	0.35	0.39
700+00	17	4000-cfs	4000.00	917.00	46.00	53.34	50.76	53.61	0.001510	7.34	4.58	4.18	962.82	223.52	208.47	0.34	0.43
700+00	17	5000-cfs	5000.00	917.00	46.00	54.15	51.21	54.35	0.001014	8.15	5.40	3.82	1677.42	514.68	208.47	0.29	0.34
700+00	18	100-cfs	100.00	1461.00	44.00	47.54	44.60	47.54	0.000012	3.54	2.13	0.22	455.55	214.33	214.33	0.03	0.00
700+00	18	250-cfs	250.00	1461.00	44.00	48.42	45.03	48.42	0.000024	4.42	2.92	0.39	647.12	221.74	221.74	0.04	0.00
700+00	18	500-cfs	500.00	1461.00	44.00	49.14	45.52	49.15	0.000046	5.14	3.56	0.62	810.01	227.85	227.85	0.06	0.01
700+00	18	750-cfs	750.00	1461.00	44.00	49.72	45.83	49.73	0.000064	5.72	4.05	0.80	943.30	232.73	232.73	0.07	0.02
700+00	18	1000-cfs	1000.00	1461.00	44.00	50.22	46.06	50.23	0.000079	6.22	4.48	0.94	1060.91	236.96	236.96	0.08	0.02
700+00	18	2000-cfs	2000.00	1461.00	44.00	51.74	46.75	51.77	0.000126	7.74	5.73	1.40	1429.86	249.74	249.74	0.10	0.04
700+00	18	3000-cfs	3000.00	1461.00	44.00	52.88	47.23	52.92	0.000156	8.88	6.81	1.75	1720.22	259.65	251.97	0.12	0.07
700+00	18	4000-cfs	4000.00	1461.00	44.00	53.78	47.63	53.85	0.000183	9.78	7.72	2.05	1959.13	267.81	251.97	0.13	0.09
700+00	18	5000-cfs	5000.00	1461.00	44.00	54.48	47.99	54.55	0.000185	10.48	8.42	2.19	2763.08	600.97	251.97	0.13	0.10
700+00	19	100-cfs	100.00	2058.00	44.00	47.55	44.77	47.55	0.000026	3.55	2.13	0.33	303.65	142.31	142.31	0.04	0.00
700+00	19	250-cfs	250.00	2058.00	44.00	48.43	45.32	48.44	0.000053	4.43	2.93	0.58	432.16	147.29	147.29	0.06	0.01
700+00	19	500-cfs	500.00	2058.00	44.00	49.17	45.83	49.19	0.000103	5.17	3.58	0.92	542.83	151.44	151.44	0.09	0.02
700+00	19	750-cfs	750.00	2058.00	44.00	49.77	46.17	49.79	0.000143	5.77	4.09	1.18	633.31	154.76	154.76	0.10	0.04
700+00	19	1000-cfs	1000.00	2058.00	44.00	50.28	46.44	50.31	0.000175	6.28	4.52	1.40	712.99	157.62	157.62	0.12	0.05
700+00	19	2000-cfs	2000.00	2058.00	44.00	51.82	47.24	51.88	0.000277	7.82	5.79	2.08	962.71	166.28	166.28	0.15	0.10
700+00	19	3000-cfs	3000.00	2058.00	44.00	52.97	47.82	53.07	0.000343	8.97	6.91	2.60	1159.03	175.27	167.30	0.17	0.15
700+00	19	4000-cfs	4000.00	2058.00	44.00	53.88	48.34	54.03	0.000401	9.88	7.82	3.05	1322.67	183.05	167.30	0.19	0.19
700+00	19	5000-cfs	5000.00	2058.00	44.00	54.58	48.81	54.74	0.000410	10.58	8.52	3.27	1861.52	417.18	167.30	0.20	0.21
700+00	20	100-cfs	100.00	2637.00	42.00	47.56	43.73	47.56	0.000032	5.56	2.02	0.35	283.63	140.49	140.49	0.04	0.00
700+00	20	250-cfs	250.00	2637.00	42.00	48.47	44.52	48.47	0.000061	6.47	2.83	0.61	413.12	146.20	146.20	0.06	0.01
700+00	20	500-cfs	500.00	2637.00	42.00	49.24	45.23	49.25	0.000113	7.24	3.49	0.95	527.63	151.08	151.08	0.09	0.02
700+00	20	750-cfs	750.00	2637.00	42.00	49.85	45.72	49.87	0.000152	7.85	4.01	1.21	621.58	154.96	154.96	0.11	0.04
700+00	20	1000-cfs	1000.00	2637.00	42.00	50.38	46.21	50.41	0.000184	8.38	4.45	1.42	704.37	158.30	158.30	0.12	0.05
700+00	20	2000-cfs	2000.00	2637.00	42.00	51.98	47.38	52.05	0.000280	9.98	5.73	2.07	965.82	168.43	168.43	0.15	0.10
700+00	20	3000-cfs	3000.00	2637.00	42.00	53.17	47.98	53.27	0.000336	11.17	6.92	2.57	1175.23	182.02	168.56	0.17	0.14

HEC-RAS Plan: 700 bathym River: Chilkat Reach: 700+00 (Continued)

Reach	River Sta	Profile	Q Total (cfs)	Cum Ch Len (ft)	Min Ch El (ft)	W.S. Elev (ft)	Crit W.S. (ft)	E.G. Elev (ft)	E.G. Slope (ft/ft)	Max Chl Dpth (ft)	Hydr Depth C (ft)	Vel Chnl (ft/s)	Flow Area (sq ft)	Top Width (ft)	Top W Chnl (ft)	Froude # Chl	Shear Chan (lb/sq ft)
700+00	20	4000-cfs	4000.00	2637.00	42.00	54.12	48.49	54.26	0.000387	12.12	7.87	3.01	1351.54	190.93	168.56	0.19	0.19
700+00	20	5000-cfs	5000.00	2637.00	42.00	54.81	48.97	55.00	0.000453	12.81	8.56	3.44	1489.07	203.13	168.56	0.21	0.24
700+00	21	100-cfs	100.00	3113.00	43.00	47.57	43.61	47.57	0.000005	4.57	3.10	0.18	567.90	183.27	183.27	0.02	0.00
700+00	21	250-cfs	250.00	3113.00	43.00	48.48	43.99	48.48	0.000012	5.48	3.89	0.34	738.14	189.76	189.76	0.03	0.00
700+00	21	500-cfs	500.00	3113.00	43.00	49.27	44.39	49.27	0.000028	6.27	4.56	0.56	889.95	195.37	195.37	0.05	0.01
700+00	21	750-cfs	750.00	3113.00	43.00	49.90	44.71	49.91	0.000041	6.90	5.08	0.74	1014.47	199.85	199.85	0.06	0.01
700+00	21	1000-cfs	1000.00	3113.00	43.00	50.44	44.98	50.46	0.000054	7.44	5.52	0.89	1124.03	203.71	203.71	0.07	0.02
700+00	21	2000-cfs	2000.00	3113.00	43.00	52.09	45.90	52.12	0.000095	9.09	6.84	1.36	1469.86	216.15	214.78	0.09	0.04
700+00	21	3000-cfs	3000.00	3113.00	43.00	53.32	46.45	53.37	0.000123	10.32	8.07	1.73	1746.21	234.92	214.78	0.11	0.06
700+00	21	4000-cfs	4000.00	3113.00	43.00	54.31	46.89	54.37	0.000148	11.31	9.06	2.05	1985.85	250.27	214.78	0.12	0.08
700+00	21	5000-cfs	5000.00	3113.00	43.00	55.05	47.31	55.13	0.000176	12.05	9.80	2.36	2174.76	258.76	214.78	0.13	0.11
700+00	22	100-cfs	100.00	3557.00	46.50	47.57	46.76	47.58	0.000250	1.07	0.90	0.58	173.73	193.42	193.42	0.11	0.01
700+00	22	250-cfs	250.00	3557.00	46.50	48.49	46.97	48.50	0.000159	1.99	1.40	0.62	405.37	289.05	289.05	0.09	0.01
700+00	22	500-cfs	500.00	3557.00	46.50	49.29	47.23	49.30	0.000147	2.79	2.11	0.78	642.33	304.44	304.44	0.09	0.02
700+00	22	750-cfs	750.00	3557.00	46.50	49.93	47.43	49.94	0.000142	3.43	2.65	0.89	840.39	316.72	316.72	0.10	0.02
700+00	22	1000-cfs	1000.00	3557.00	46.50	50.48	47.62	50.49	0.000140	3.98	3.11	0.98	1017.21	327.30	327.30	0.10	0.03
700+00	22	2000-cfs	2000.00	3557.00	46.50	52.15	48.22	52.17	0.000141	5.65	4.46	1.26	1590.87	357.81	356.63	0.10	0.04
700+00	22	3000-cfs	3000.00	3557.00	46.50	53.39	48.59	53.43	0.000140	6.89	5.70	1.47	2041.90	367.31	356.63	0.11	0.05
700+00	22	4000-cfs	4000.00	3557.00	46.50	54.39	48.91	54.44	0.000144	7.89	6.71	1.67	2413.56	374.77	356.63	0.11	0.06
700+00	22	5000-cfs	5000.00	3557.00	46.50	55.16	49.21	55.21	0.000157	8.66	7.47	1.87	2701.53	380.95	356.63	0.12	0.07
700+00	23	100-cfs	100.00	4016.00	49.00	49.24	49.24	49.36	0.036322	0.24	0.23	2.83	35.40	151.64	151.64	1.03	0.53
700+00	23	250-cfs	250.00	4016.00	49.00	49.45	49.45	49.66	0.028268	0.45	0.43	3.72	67.25	158.15	158.15	1.00	0.75
700+00	23	500-cfs	500.00	4016.00	49.00	49.70	49.70	50.03	0.023980	0.70	0.66	4.58	109.29	166.36	166.36	0.99	0.98
700+00	23	750-cfs	750.00	4016.00	49.00	49.91	49.91	50.33	0.022173	0.91	0.84	5.17	144.96	173.02	173.02	1.00	1.16
700+00	23	1000-cfs	1000.00	4016.00	49.00	50.52	50.11	50.76	0.006884	1.52	1.33	3.92	255.18	192.13	192.13	0.60	0.57
700+00	23	2000-cfs	2000.00	4016.00	49.00	52.21	50.70	52.37	0.001853	3.21	2.62	3.20	626.88	249.21	239.06	0.35	0.30
700+00	23	3000-cfs	3000.00	4016.00	49.00	53.44	51.18	53.60	0.001127	4.44	3.85	3.22	968.82	305.98	239.06	0.29	0.27
700+00	23	4000-cfs	4000.00	4016.00	49.00	54.44	51.60	54.61	0.000891	5.44	4.85	3.34	1295.67	348.47	239.06	0.27	0.27
700+00	23	5000-cfs	5000.00	4016.00	49.00	55.20	51.98	55.39	0.000822	6.20	5.61	3.54	1573.30	379.55	239.06	0.26	0.29

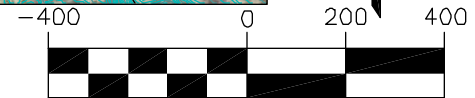
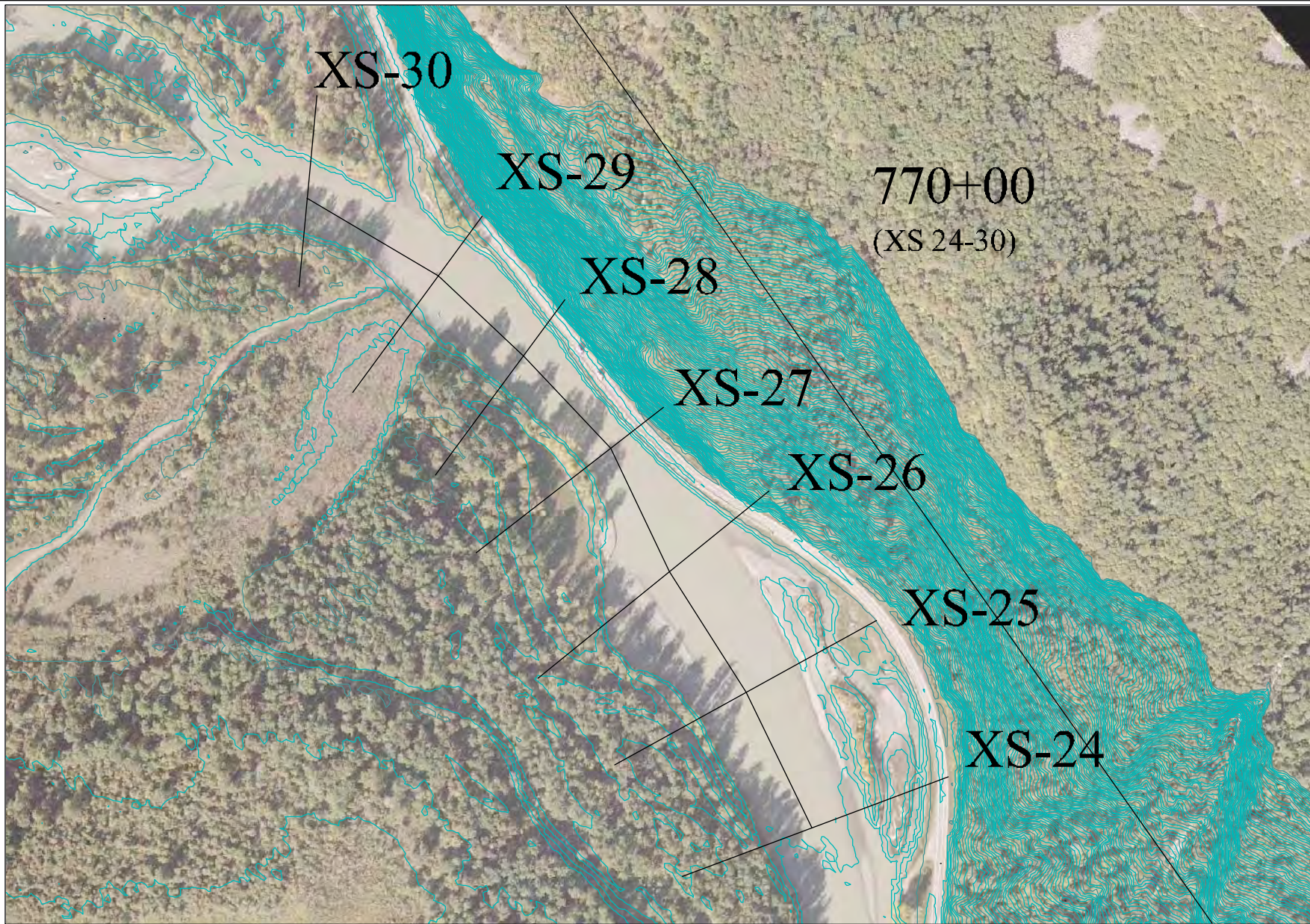

1 inch = 400ft.



770+00 Plan: 770+00 - LIDAR 11/15/2005
RS = 30

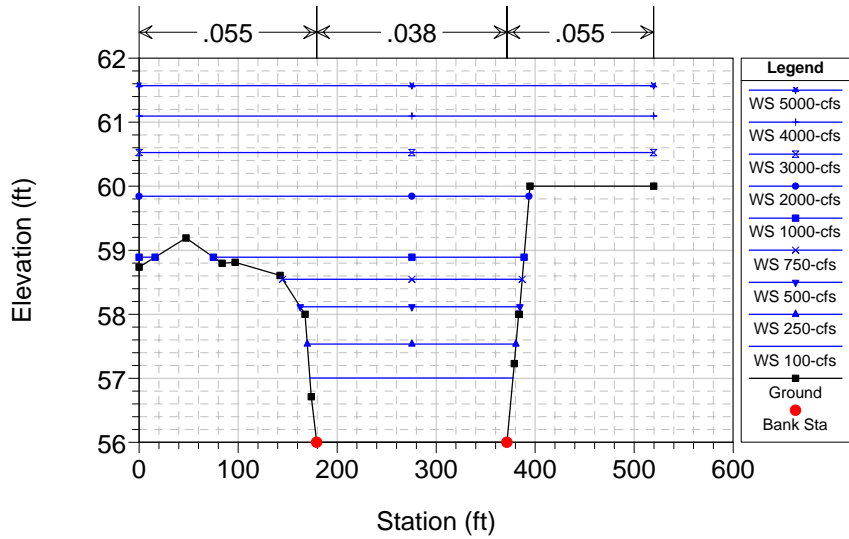

770+00 Plan: 770+00 - LIDAR 11/15/2005
RS = 29

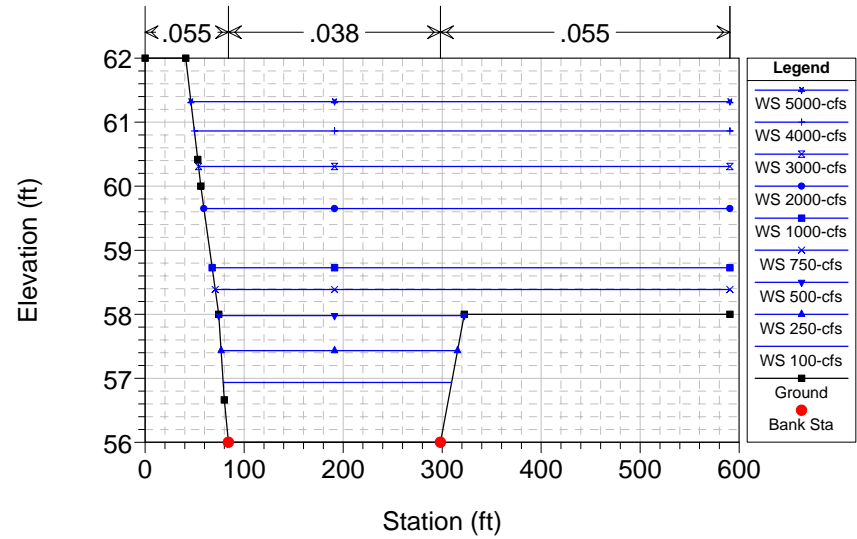

770+00 Plan: 770+00 - LIDAR 11/15/2005
RS = 28

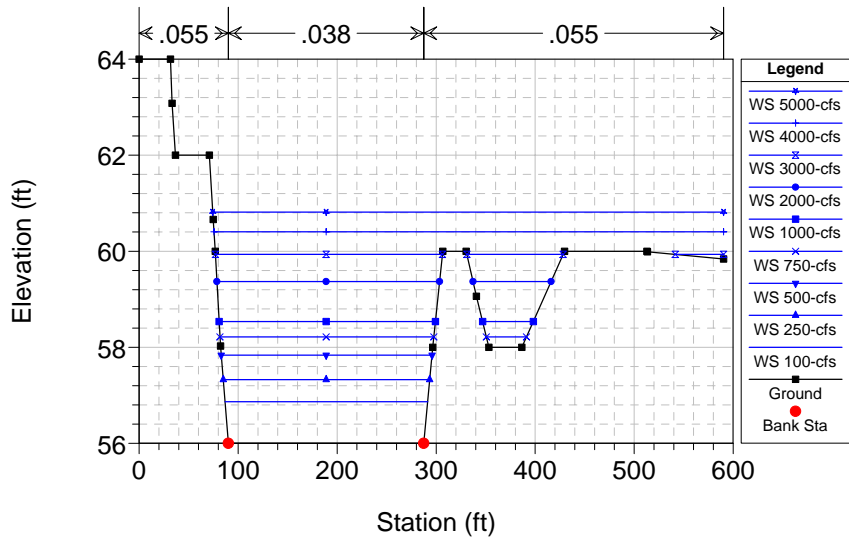

770+00 Plan: 770+00 - LIDAR 11/15/2005
RS = 27

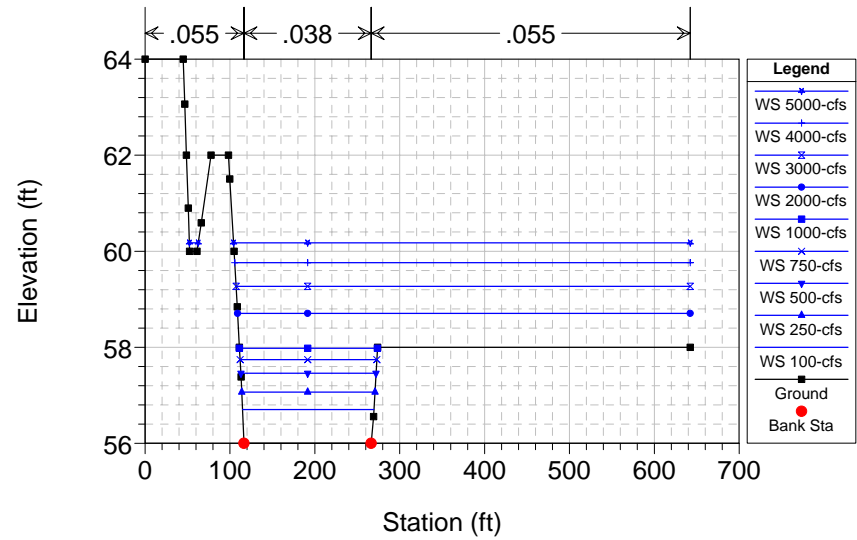

770+00 Plan: 770+00 - LIDAR 11/15/2005

RS = 26

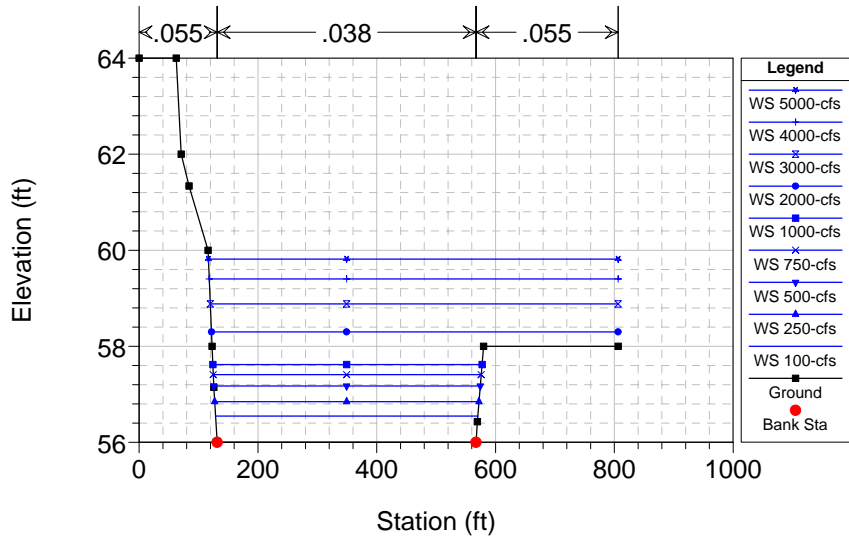

770+00 Plan: 770+00 - LIDAR 11/15/2005

RS = 25

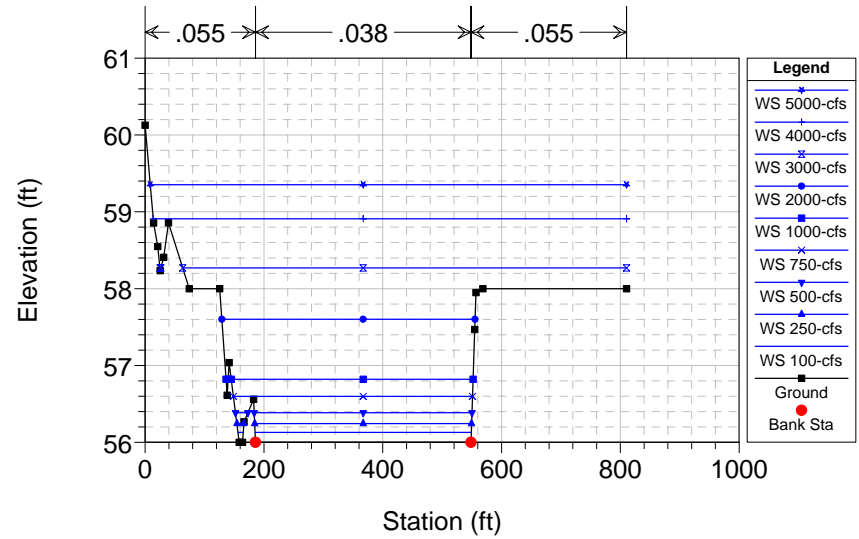

770+00 Plan: 770+00 - LIDAR 11/15/2005

RS = 24

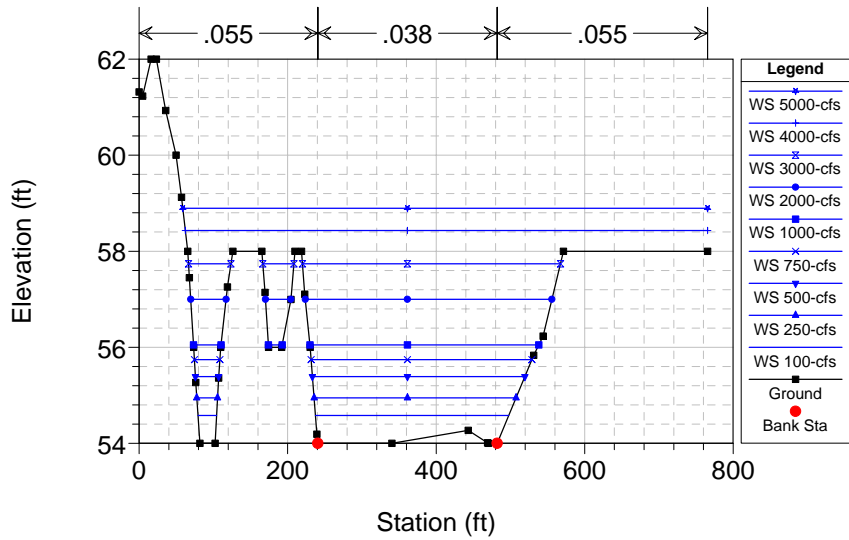

HEC-RAS Plan: 770 LIDAR River: Chilkat Reach: 770+00

Reach	River Sta	Profile	Q Total (cfs)	Cum Ch Len (ft)	Min Ch El (ft)	W.S. Elev (ft)	Crit W.S. (ft)	E.G. Elev (ft)	E.G. Slope (ft/ft)	Max Chl Dpth (ft)	Hydr Depth C (ft)	Vel Chnl (ft/s)	Flow Area (sq ft)	Top Width (ft)	Top W Chnl (ft)	Froude # Chl	Shear Chan (lb/sq ft)
770+00	24	100-cfs	100.00		54.00	54.58	54.22	54.59	0.000902	0.58	0.51	0.75	140.85	285.28	241.56	0.18	0.03
770+00	24	250-cfs	250.00		54.00	54.95	54.37	54.96	0.000901	0.95	0.87	1.07	248.63	299.88	241.56	0.20	0.05
770+00	24	500-cfs	500.00		54.00	55.39	54.54	55.42	0.000901	1.39	1.32	1.41	385.05	317.32	241.56	0.22	0.07
770+00	24	750-cfs	750.00		54.00	55.74	54.69	55.78	0.000901	1.74	1.67	1.65	499.65	331.42	241.56	0.23	0.09
770+00	24	1000-cfs	1000.00		54.00	56.05	54.82	56.10	0.000901	2.05	1.97	1.85	603.64	363.52	241.56	0.23	0.11
770+00	24	2000-cfs	2000.00		54.00	57.00	55.26	57.08	0.000900	3.00	2.93	2.40	974.70	414.23	241.56	0.25	0.16
770+00	24	3000-cfs	3000.00		54.00	57.74	55.62	57.84	0.000901	3.74	3.66	2.79	1292.48	446.59	241.56	0.26	0.21
770+00	24	4000-cfs	4000.00		54.00	58.43	55.93	58.56	0.000901	4.43	4.36	3.13	1713.72	703.39	241.56	0.26	0.25
770+00	24	5000-cfs	5000.00		54.00	58.90	56.25	59.04	0.000900	4.90	4.82	3.35	2041.28	706.86	241.56	0.27	0.27
770+00	25	100-cfs	100.00	407.00	56.00	56.13	56.13	56.20	0.044458	0.13	0.13	2.11	47.88	372.86	362.68	1.03	0.36
770+00	25	250-cfs	250.00	407.00	56.00	56.24	56.24	56.36	0.033779	0.24	0.24	2.80	90.47	376.87	362.68	1.00	0.51
770+00	25	500-cfs	500.00	407.00	56.00	56.38	56.38	56.58	0.029101	0.38	0.38	3.53	144.53	387.26	362.68	1.00	0.70
770+00	25	750-cfs	750.00	407.00	56.00	56.60	56.50	56.77	0.014831	0.60	0.60	3.38	228.81	402.35	362.68	0.77	0.55
770+00	25	1000-cfs	1000.00	407.00	56.00	56.82	56.61	56.98	0.008984	0.82	0.82	3.25	319.27	410.45	362.68	0.63	0.46
770+00	25	2000-cfs	2000.00	407.00	56.00	57.60		57.76	0.003680	1.60	1.60	3.25	647.77	426.17	362.68	0.45	0.37
770+00	25	3000-cfs	3000.00	407.00	56.00	58.27		58.44	0.002538	2.27	2.27	3.40	1018.33	748.76	362.68	0.40	0.36
770+00	25	4000-cfs	4000.00	407.00	56.00	58.91		59.06	0.001699	2.91	2.91	3.28	1514.20	796.83	362.68	0.34	0.31
770+00	25	5000-cfs	5000.00	407.00	56.00	59.35		59.50	0.001489	3.35	3.35	3.38	1869.56	801.80	362.68	0.33	0.31
770+00	26	100-cfs	100.00	794.00	56.00	56.55		56.55	0.000255	0.55	0.55	0.42	240.23	441.38	435.54	0.10	0.01
770+00	26	250-cfs	250.00	794.00	56.00	56.85		56.85	0.000374	0.85	0.85	0.68	371.97	444.90	435.54	0.13	0.02
770+00	26	500-cfs	500.00	794.00	56.00	57.17		57.19	0.000498	1.17	1.17	0.97	519.07	448.74	435.54	0.16	0.04
770+00	26	750-cfs	750.00	794.00	56.00	57.41		57.43	0.000609	1.41	1.41	1.21	624.74	451.08	435.54	0.18	0.05
770+00	26	1000-cfs	1000.00	794.00	56.00	57.62		57.65	0.000680	1.62	1.62	1.41	719.42	453.17	435.54	0.19	0.07
770+00	26	2000-cfs	2000.00	794.00	56.00	58.30		58.36	0.000823	2.30	2.30	1.95	1097.38	684.37	435.54	0.23	0.12
770+00	26	3000-cfs	3000.00	794.00	56.00	58.88		58.96	0.000803	2.88	2.88	2.24	1497.83	686.38	435.54	0.23	0.14
770+00	26	4000-cfs	4000.00	794.00	56.00	59.40		59.49	0.000771	3.40	3.40	2.46	1853.99	688.17	435.54	0.23	0.16
770+00	26	5000-cfs	5000.00	794.00	56.00	59.81		59.92	0.000788	3.81	3.81	2.68	2138.51	689.59	435.54	0.24	0.19
770+00	27	100-cfs	100.00	1163.00	56.00	56.70		56.72	0.000930	0.70	0.70	0.94	107.12	154.88	149.91	0.20	0.04
770+00	27	250-cfs	250.00	1163.00	56.00	57.07		57.10	0.001435	1.07	1.07	1.55	163.90	156.96	149.91	0.26	0.10
770+00	27	500-cfs	500.00	1163.00	56.00	57.46		57.54	0.002012	1.46	1.46	2.26	225.76	159.25	149.91	0.33	0.18
770+00	27	750-cfs	750.00	1163.00	56.00	57.74		57.86	0.002489	1.74	1.74	2.82	271.26	161.12	149.91	0.38	0.27
770+00	27	1000-cfs	1000.00	1163.00	56.00	57.98		58.15	0.002887	1.98	1.98	3.31	309.45	162.67	149.91	0.41	0.36
770+00	27	2000-cfs	2000.00	1163.00	56.00	58.71		58.93	0.002914	2.71	2.71	4.10	688.64	533.38	149.91	0.44	0.49
770+00	27	3000-cfs	3000.00	1163.00	56.00	59.27		59.50	0.002657	3.27	3.27	4.44	989.60	535.16	149.91	0.43	0.54
770+00	27	4000-cfs	4000.00	1163.00	56.00	59.76		60.01	0.002460	3.76	3.76	4.69	1254.14	536.77	149.91	0.43	0.58
770+00	27	5000-cfs	5000.00	1163.00	56.00	60.17		60.44	0.002406	4.17	4.17	4.97	1476.99	548.51	149.91	0.43	0.63
770+00	28	100-cfs	100.00	1507.00	56.00	56.87		56.87	0.000266	0.87	0.87	0.58	174.35	204.70	197.38	0.11	0.01
770+00	28	250-cfs	250.00	1507.00	56.00	57.33		57.34	0.000398	1.33	1.33	0.94	269.47	208.59	197.38	0.14	0.03
770+00	28	500-cfs	500.00	1507.00	56.00	57.83		57.86	0.000537	1.83	1.83	1.36	376.37	212.87	197.38	0.18	0.06
770+00	28	750-cfs	750.00	1507.00	56.00	58.22		58.26	0.000636	2.22	2.22	1.68	466.22	256.48	197.38	0.20	0.09
770+00	28	1000-cfs	1000.00	1507.00	56.00	58.54		58.59	0.000707	2.54	2.54	1.93	550.45	269.65	197.38	0.21	0.11
770+00	28	2000-cfs	2000.00	1507.00	56.00	59.37		59.48	0.001033	3.37	3.37	2.82	788.57	303.60	197.38	0.27	0.22
770+00	28	3000-cfs	3000.00	1507.00	56.00	59.93		60.11	0.001325	3.93	3.93	3.55	969.21	375.37	197.38	0.32	0.33
770+00	28	4000-cfs	4000.00	1507.00	56.00	60.41		60.65	0.001568	4.41	4.41	4.16	1203.85	514.69	197.38	0.35	0.43
770+00	28	5000-cfs	5000.00	1507.00	56.00	60.82		61.10	0.001671	4.82	4.82	4.56	1415.43	515.97	197.38	0.37	0.50
770+00	29	100-cfs	100.00	1823.00	56.00	56.94		56.94	0.000172	0.94	0.94	0.49	208.31	230.71	214.17	0.09	0.01
770+00	29	250-cfs	250.00	1823.00	56.00	57.43		57.44	0.000256	1.43	1.43	0.79	324.77	238.79	214.17	0.12	0.02
770+00	29	500-cfs	500.00	1823.00	56.00	57.98		58.00	0.000342	1.98	1.98	1.14	457.64	247.69	214.17	0.14	0.04
770+00	29	750-cfs	750.00	1823.00	56.00	58.39		58.41	0.000382	2.39	2.39	1.36	663.66	519.76	214.17	0.16	0.06
770+00	29	1000-cfs	1000.00	1823.00	56.00	58.73		58.76	0.000389	2.73	2.73	1.50	840.59	522.83	214.17	0.16	0.07
770+00	29	2000-cfs	2000.00	1823.00	56.00	59.65		59.70	0.000457	3.65	3.65	1.98	1327.57	531.19	214.17	0.18	0.10
770+00	29	3000-cfs	3000.00	1823.00	56.00	60.31		60.38	0.000521	4.31	4.31	2.36	1678.55	536.60	214.17	0.20	0.14

HEC-RAS Plan: 770 LIDAR River: Chilkat Reach: 770+00 (Continued)

Reach	River Sta	Profile	Q Total (cfs)	Cum Ch Len (ft)	Min Ch El (ft)	W.S. Elev (ft)	Crit W.S. (ft)	E.G. Elev (ft)	E.G. Slope (ft/ft)	Max Chl Dpth (ft)	Hydr Depth C (ft)	Vel Chnl (ft/s)	Flow Area (sq ft)	Top Width (ft)	Top W Chnl (ft)	Froude # Chl	Shear Chan (lb/sq ft)
770+00	29	4000-cfs	4000.00	1823.00	56.00	60.86		60.95	0.000569	4.86	4.86	2.68	1977.45	540.83	214.17	0.21	0.17
770+00	29	5000-cfs	5000.00	1823.00	56.00	61.32		61.42	0.000622	5.32	5.32	2.97	2225.05	544.34	214.17	0.23	0.21
770+00	30	100-cfs	100.00	2236.00	56.00	57.01		57.01	0.000169	1.01	1.01	0.51	199.99	205.14	192.13	0.09	0.01
770+00	30	250-cfs	250.00	2236.00	56.00	57.54		57.55	0.000253	1.54	1.54	0.83	310.26	210.79	192.13	0.12	0.02
770+00	30	500-cfs	500.00	2236.00	56.00	58.12		58.14	0.000344	2.12	2.12	1.20	434.98	221.90	192.13	0.14	0.05
770+00	30	750-cfs	750.00	2236.00	56.00	58.55		58.58	0.000414	2.55	2.55	1.48	534.45	242.02	192.13	0.16	0.07
770+00	30	1000-cfs	1000.00	2236.00	56.00	58.89		58.94	0.000478	2.89	2.89	1.73	630.45	329.87	192.13	0.18	0.09
770+00	30	2000-cfs	2000.00	2236.00	56.00	59.84		59.93	0.000639	3.84	3.84	2.43	994.40	393.87	192.13	0.22	0.15
770+00	30	3000-cfs	3000.00	2236.00	56.00	60.53		60.64	0.000750	4.53	4.53	2.93	1328.63	519.66	192.13	0.24	0.21
770+00	30	4000-cfs	4000.00	2236.00	56.00	61.10		61.23	0.000798	5.10	5.10	3.27	1624.97	519.66	192.13	0.26	0.25
770+00	30	5000-cfs	5000.00	2236.00	56.00	61.57		61.73	0.000852	5.57	5.57	3.59	1871.53	519.66	192.13	0.27	0.30

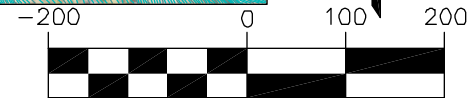

813 Plan: 813+00-LIDAR 11/16/2005

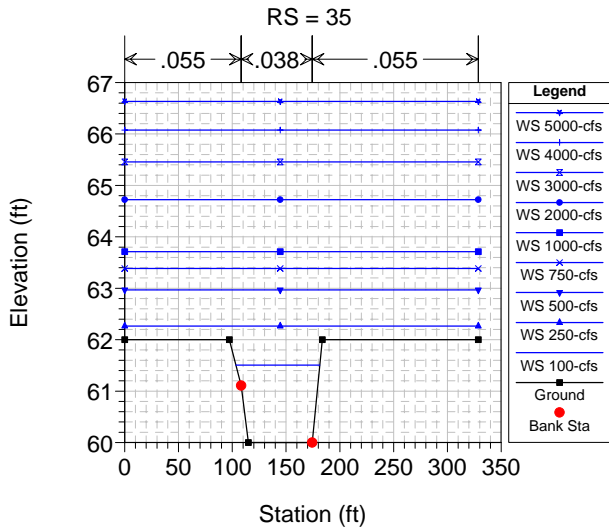

813 Plan: 813+00-LIDAR 11/16/2005

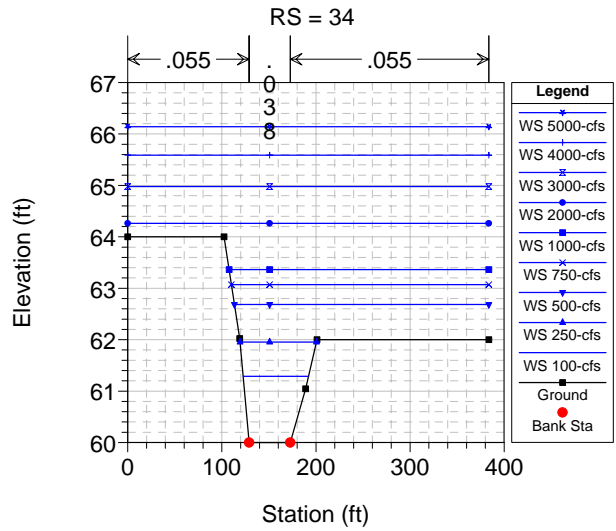

813 Plan: 813+00-LIDAR 11/16/2005

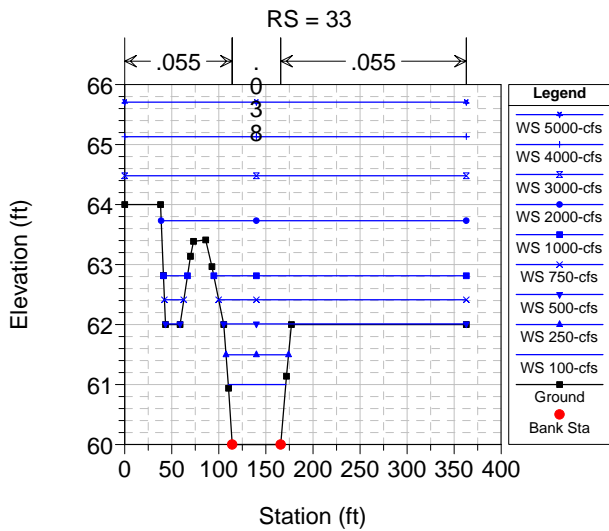

813 Plan: 813+00-LIDAR 11/16/2005

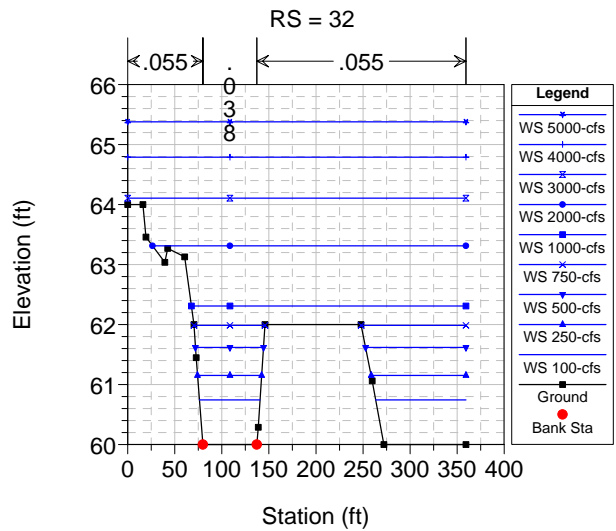

813 Plan: 813+00-LIDAR 11/16/2005

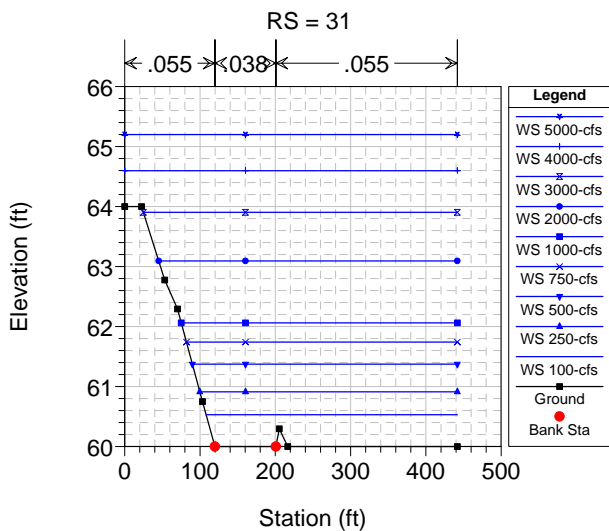

HEC-RAS Plan: 813 LIDAR River: Chilkat Reach: 813+00

Reach	River Sta	Profile	Q Total (cfs)	Cum Ch Len (ft)	Min Ch El (ft)	W.S. Elev (ft)	Crit W.S. (ft)	E.G. Elev (ft)	E.G. Slope (ft/ft)	Max Chl Dpth (ft)	Hydr Depth C (ft)	Vel Chnl (ft/s)	Flow Area (sq ft)	Top Width (ft)	Top W Chnl (ft)	Froude # Chl	Shear Chan (lb/sq ft)
813+00	31	100-cfs	100.00		60.00	60.53	60.15	60.54	0.000901	0.53	0.53	0.77	171.75	333.76	80.92	0.19	0.03
813+00	31	250-cfs	250.00		60.00	60.91	60.28	60.92	0.000901	0.91	0.91	1.10	300.43	342.10	80.92	0.20	0.05
813+00	31	500-cfs	500.00		60.00	61.37	60.44	61.39	0.000900	1.37	1.37	1.45	460.20	351.95	80.92	0.22	0.08
813+00	31	750-cfs	750.00		60.00	61.74	60.58	61.77	0.000901	1.74	1.74	1.70	591.74	359.85	80.92	0.23	0.10
813+00	31	1000-cfs	1000.00		60.00	62.06	60.69	62.10	0.000900	2.06	2.06	1.90	708.19	366.71	80.92	0.23	0.12
813+00	31	2000-cfs	2000.00		60.00	63.09	61.09	63.15	0.000901	3.09	3.09	2.49	1101.13	396.63	80.92	0.25	0.17
813+00	31	3000-cfs	3000.00		60.00	63.90	61.42	63.98	0.000900	3.90	3.90	2.91	1431.83	417.03	80.92	0.26	0.22
813+00	31	4000-cfs	4000.00		60.00	64.60	61.72	64.70	0.000901	4.60	4.60	3.25	1736.04	441.79	80.92	0.27	0.26
813+00	31	5000-cfs	5000.00		60.00	65.20	61.99	65.31	0.000901	5.20	5.20	3.52	2001.32	441.79	80.92	0.27	0.29
813+00	32	100-cfs	100.00	209.00	60.00	60.74		60.76	0.001222	0.74	0.74	1.12	113.37	160.32	57.37	0.23	0.06
813+00	32	250-cfs	250.00	209.00	60.00	61.15		61.19	0.001740	1.15	1.15	1.79	180.50	168.88	57.37	0.29	0.13
813+00	32	500-cfs	500.00	209.00	60.00	61.62		61.69	0.002180	1.62	1.62	2.52	261.91	178.96	57.37	0.35	0.22
813+00	32	750-cfs	750.00	209.00	60.00	61.99		62.08	0.002436	1.99	1.99	3.05	328.87	186.69	57.37	0.38	0.30
813+00	32	1000-cfs	1000.00	209.00	60.00	62.31		62.45	0.003099	2.31	2.31	3.80	421.50	291.70	57.37	0.44	0.45
813+00	32	2000-cfs	2000.00	209.00	60.00	63.31		63.48	0.002502	3.31	3.31	4.34	721.98	332.96	57.37	0.42	0.52
813+00	32	3000-cfs	3000.00	209.00	60.00	64.11		64.30	0.002216	4.11	4.11	4.72	994.85	359.39	57.37	0.41	0.57
813+00	32	4000-cfs	4000.00	209.00	60.00	64.79		65.00	0.002034	4.79	4.79	5.01	1240.06	359.39	57.37	0.40	0.61
813+00	32	5000-cfs	5000.00	209.00	60.00	65.38		65.62	0.001953	5.38	5.38	5.31	1452.26	359.39	57.37	0.40	0.66
813+00	33	100-cfs	100.00	383.00	60.00	61.00		61.05	0.002276	1.00	1.00	1.87	56.29	61.02	51.61	0.33	0.14
813+00	33	250-cfs	250.00	383.00	60.00	61.50		61.64	0.003579	1.50	1.50	3.06	87.88	66.35	51.61	0.44	0.33
813+00	33	500-cfs	500.00	383.00	60.00	62.01	61.39	62.33	0.005503	2.01	2.01	4.62	125.49	273.31	51.61	0.57	0.69
813+00	33	750-cfs	750.00	383.00	60.00	62.41		62.73	0.004907	2.41	2.41	4.93	237.69	283.60	51.61	0.56	0.74
813+00	33	1000-cfs	1000.00	383.00	60.00	62.81		63.07	0.003722	2.81	2.81	4.75	353.07	293.81	51.61	0.50	0.65
813+00	33	2000-cfs	2000.00	383.00	60.00	63.73		64.00	0.003286	3.73	3.73	5.39	637.42	324.13	51.61	0.49	0.77
813+00	33	3000-cfs	3000.00	383.00	60.00	64.48		64.77	0.002948	4.48	4.48	5.77	898.61	362.90	51.61	0.48	0.82
813+00	33	4000-cfs	4000.00	383.00	60.00	65.13		65.43	0.002643	5.13	5.13	5.98	1134.86	362.90	51.61	0.47	0.85
813+00	33	5000-cfs	5000.00	383.00	60.00	65.71		66.02	0.002476	5.71	5.71	6.21	1343.71	362.90	51.61	0.46	0.88
813+00	34	100-cfs	100.00	554.00	60.00	61.29		61.32	0.001149	1.29	1.29	1.57	73.26	69.51	43.70	0.24	0.09
813+00	34	250-cfs	250.00	554.00	60.00	61.95		62.03	0.001600	1.95	1.95	2.44	123.42	81.21	43.70	0.31	0.20
813+00	34	500-cfs	500.00	554.00	60.00	62.68		62.77	0.001361	2.68	2.68	2.79	310.10	270.16	43.70	0.30	0.23
813+00	34	750-cfs	750.00	554.00	60.00	63.07		63.17	0.001446	3.07	3.07	3.14	414.99	273.41	43.70	0.32	0.28
813+00	34	1000-cfs	1000.00	554.00	60.00	63.36		63.47	0.001577	3.36	3.36	3.49	495.45	275.88	43.70	0.33	0.33
813+00	34	2000-cfs	2000.00	554.00	60.00	64.26		64.44	0.001962	4.26	4.26	4.55	773.85	383.62	43.70	0.39	0.52
813+00	34	3000-cfs	3000.00	554.00	60.00	64.98		65.18	0.001947	4.98	4.98	5.03	1047.78	383.62	43.70	0.40	0.60
813+00	34	4000-cfs	4000.00	554.00	60.00	65.59		65.81	0.001930	5.59	5.59	5.41	1281.67	383.62	43.70	0.40	0.67
813+00	34	5000-cfs	5000.00	554.00	60.00	66.14		66.39	0.001905	6.14	6.14	5.72	1494.05	383.62	43.70	0.41	0.73
813+00	35	100-cfs	100.00	855.00	60.00	61.50		61.52	0.000414	1.50	1.45	1.02	101.99	78.01	66.11	0.15	0.04
813+00	35	250-cfs	250.00	855.00	60.00	62.27		62.30	0.000542	2.27	2.21	1.54	230.14	328.74	66.11	0.18	0.07
813+00	35	500-cfs	500.00	855.00	60.00	62.97		63.00	0.000486	2.97	2.91	1.76	461.31	328.74	66.11	0.18	0.09
813+00	35	750-cfs	750.00	855.00	60.00	63.38		63.43	0.000547	3.38	3.33	2.04	597.63	328.74	66.11	0.20	0.11
813+00	35	1000-cfs	1000.00	855.00	60.00	63.71		63.76	0.000609	3.71	3.66	2.29	705.40	328.74	66.11	0.21	0.14
813+00	35	2000-cfs	2000.00	855.00	60.00	64.72		64.81	0.000772	4.72	4.67	3.03	1037.31	328.74	66.11	0.25	0.22
813+00	35	3000-cfs	3000.00	855.00	60.00	65.46		65.57	0.000910	5.46	5.40	3.63	1278.92	328.74	66.11	0.28	0.31
813+00	35	4000-cfs	4000.00	855.00	60.00	66.08		66.23	0.001018	6.08	6.02	4.13	1482.86	328.74	66.11	0.30	0.38
813+00	35	5000-cfs	5000.00	855.00	60.00	66.63		66.82	0.001102	6.63	6.58	4.55	1665.84	328.74	66.11	0.31	0.45

23.5.2 Hydraulic Output – Tributaries

Conversion from relative datum: As described in Section 3.2 cursory survey was collected as part of Inter-Fluve’s October 2005 field investigations. These survey data were used for the preliminary HEC-RAS hydraulic modeling shown in this appendix. Approximate conversions to ADOT&PF datum was obtained by comparing elevations of features at each site surveyed by Inter-Fluve and ADOT&PF or Toner-Nordling. The approximate datum conversion is noted below. Subtract the elevation difference noted in the table from the Inter-Fluve survey and models for stations noted in the table to obtain approximate ADOT&PF elevations. Elevations for culverts not noted in the table are based on ADOT&PF datum. Design level survey of stream cross sections, topography, bathymetry and profiles – based on ADOT&PF project datum - will be required at all culverts to finalize designs for submittal at Plans-in-Hand.

Culvert (2009 Stationing)	Datum conversion elevation difference (IFI interim datum) – (elevation difference) ~ (ADOT&PF datum)
222+51	74.42-ft
319+13	68.83-ft
324+79	69.17-ft
483+18	57.63-ft
512+24	57.88-ft

Tributary 222+51 HEC-RAS

Companion 2006 Stream and Habitat Inventory (S&HI) station 245+50
Model based on relative datum. Subtract 74.42-ft for approximate conversion to
ADOT&PF project datum

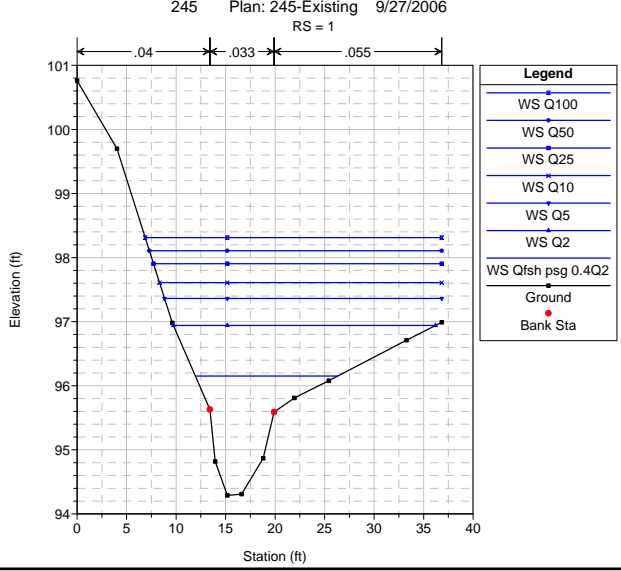
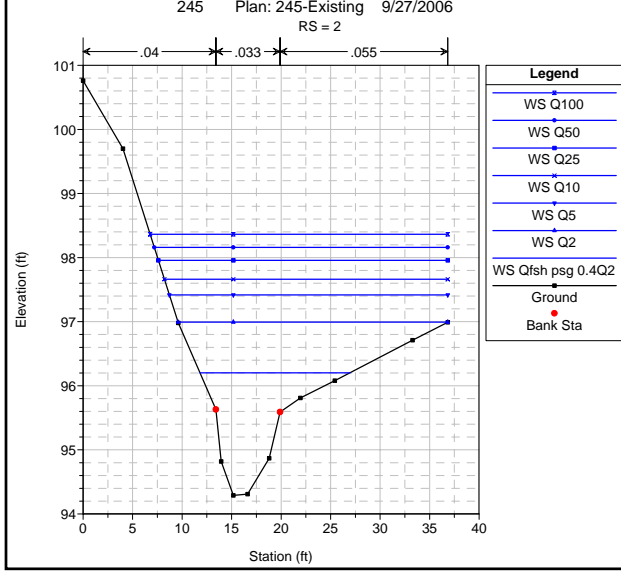
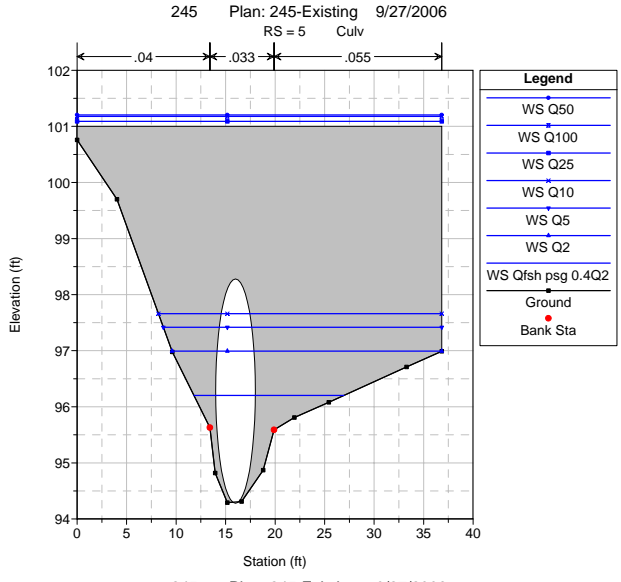
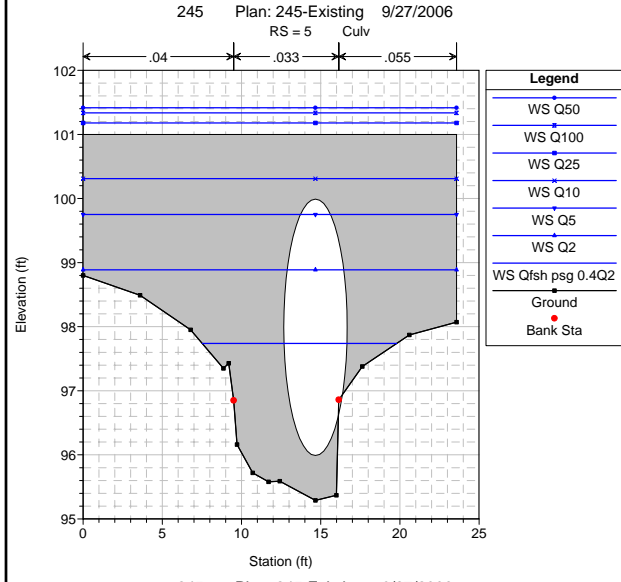
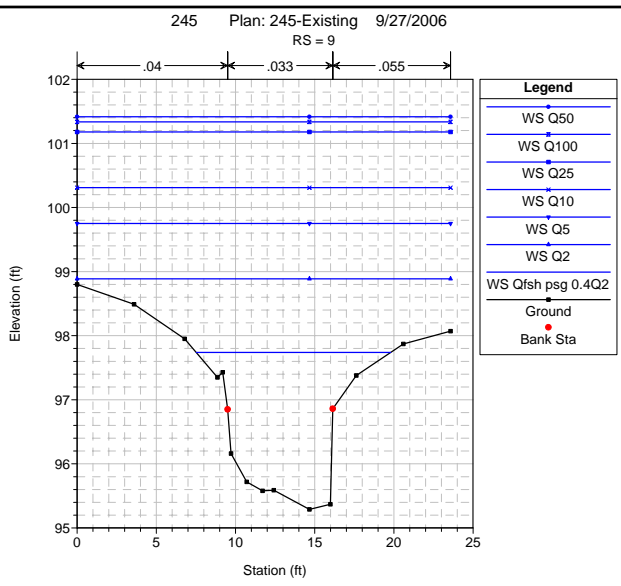
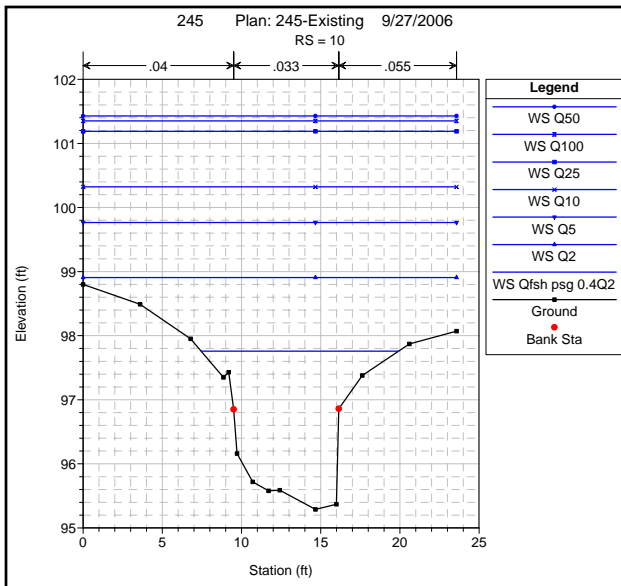

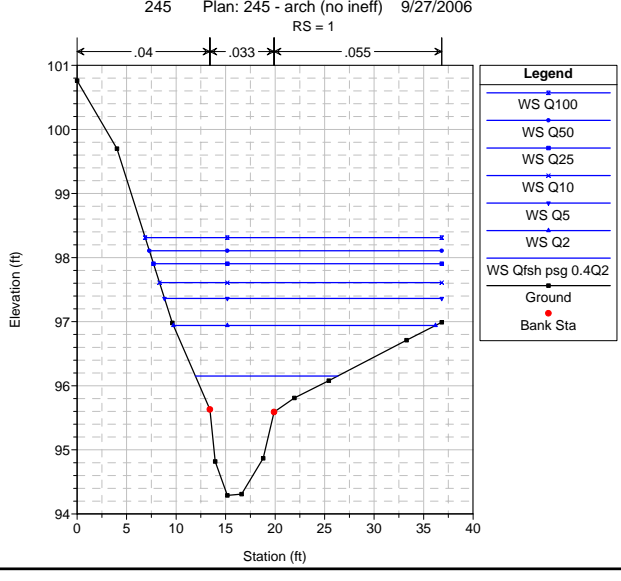
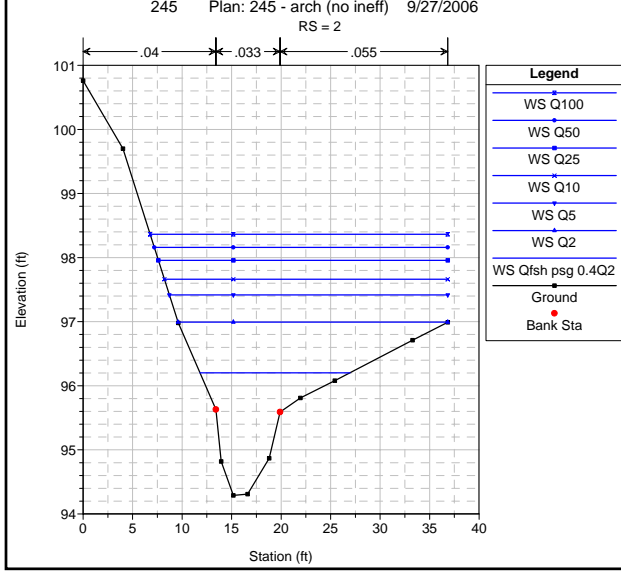
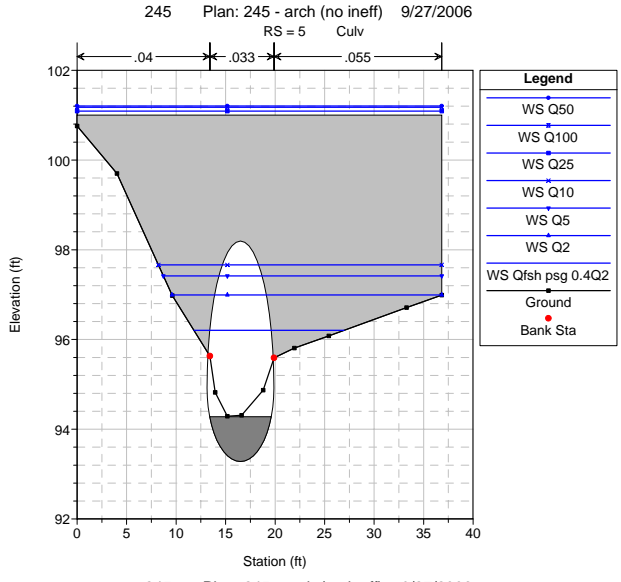
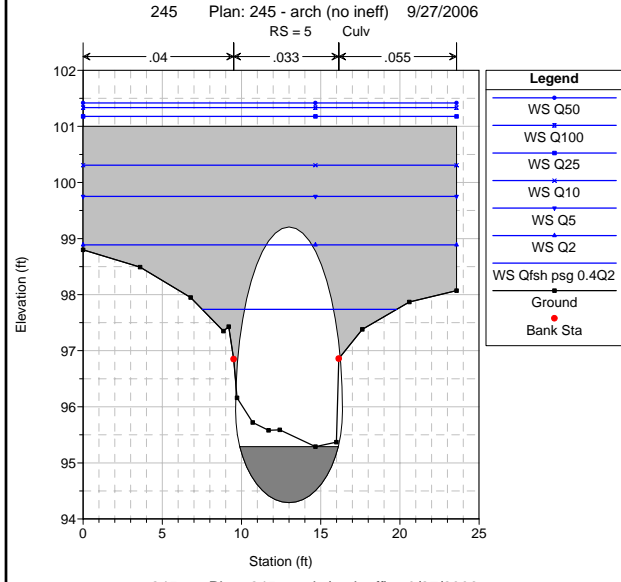
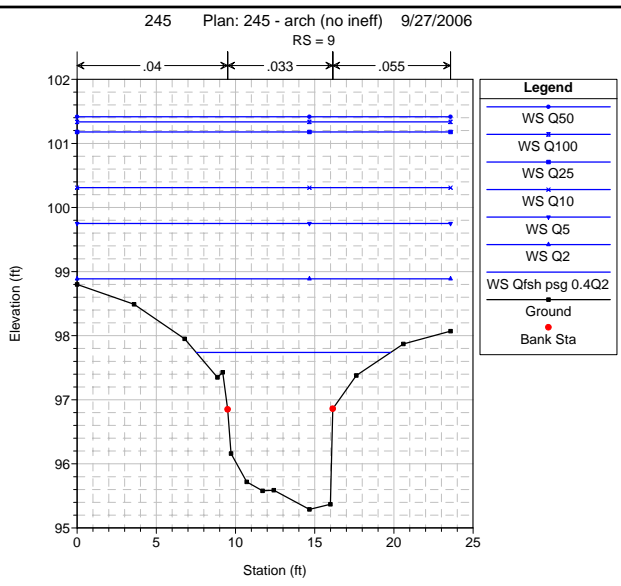
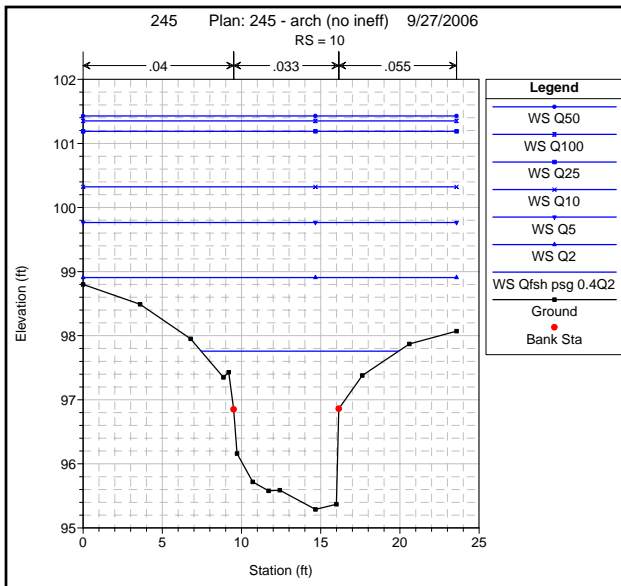

HEC-RAS River: Trib 245 Reach: 245

Reach	River Sta	Profile	Plan	Q Total (cfs)	Cum Ch Len (ft)	Min Ch El (ft)	W.S. Elev (ft)	Crit W.S. (ft)	E.G. Elev (ft)	E.G. Slope (ft/ft)	Max Chl Dpth (ft)	Hydr Depth C (ft)	Vel Chnl (ft/s)	Flow Area (sq ft)	Top Width (ft)	Top W Chnl (ft)	Froude # Chl	Shear Chan (lb/sq ft)
245	1	Lo	Arch -noinef	5.00		94.29	95.37	94.81	95.39	0.001001	1.08	0.76	1.11	4.51	5.97	5.97	0.22	0.04
245	1	Lo	245-Ex	5.00		94.29	95.37	94.81	95.39	0.001001	1.08	0.76	1.11	4.51	5.97	5.97	0.22	0.04
245	1	Lo	Arch -noinef	10.00		94.29	95.78	95.01	95.81	0.001001	1.49	1.10	1.40	7.32	8.67	6.48	0.24	0.06
245	1	Lo	245-Ex	10.00		94.29	95.78	95.01	95.81	0.001001	1.49	1.10	1.40	7.32	8.67	6.48	0.24	0.06
245	1	Q1sh psg 0.4Q2	Arch -noinef	17.00		94.29	96.15	95.23	96.20	0.001001	1.86	1.47	1.70	11.61	14.40	6.48	0.25	0.08
245	1	Q1sh psg 0.4Q2	245-Ex	17.00		94.29	96.15	95.23	96.20	0.001001	1.86	1.47	1.70	11.61	14.40	6.48	0.25	0.08
245	1	Lo	Arch -noinef	30.00		94.29	96.62	95.54	96.68	0.001002	2.33	1.94	2.05	20.06	21.57	6.48	0.26	0.11
245	1	Lo	245-Ex	30.00		94.29	96.62	95.54	96.68	0.001002	2.33	1.94	2.05	20.06	21.57	6.48	0.26	0.11
245	1	Q2	Arch -noinef	42.00		94.29	96.94	95.79	97.00	0.001000	2.65	2.26	2.26	27.68	26.48	6.48	0.27	0.13
245	1	Q2	245-Ex	42.00		94.29	96.94	95.79	97.00	0.001000	2.65	2.26	2.26	27.68	26.48	6.48	0.27	0.13
245	1	Q5	Arch -noinef	64.00		94.29	97.36	96.22	97.44	0.001001	3.07	2.68	2.54	39.36	28.02	6.48	0.27	0.15
245	1	Q5	245-Ex	64.00		94.29	97.36	96.22	97.44	0.001001	3.07	2.68	2.54	39.36	28.02	6.48	0.27	0.15
245	1	Q10	Arch -noinef	79.00		94.29	97.61	96.43	97.69	0.001001	3.32	2.93	2.69	46.29	28.52	6.48	0.28	0.16
245	1	Q10	245-Ex	79.00		94.29	97.61	96.43	97.69	0.001001	3.32	2.93	2.69	46.29	28.52	6.48	0.28	0.16
245	1	Q25	Arch -noinef	99.00		94.29	97.90	96.66	97.99	0.001001	3.61	3.22	2.87	54.79	29.13	6.48	0.28	0.18
245	1	Q25	245-Ex	99.00		94.29	97.90	96.66	97.99	0.001001	3.61	3.22	2.87	54.79	29.13	6.48	0.28	0.18
245	1	Q50	Arch -noinef	114.00		94.29	98.11	96.80	98.20	0.001002	3.82	3.43	2.99	60.72	29.54	6.48	0.28	0.19
245	1	Q50	245-Ex	114.00		94.29	98.11	96.80	98.20	0.001002	3.82	3.43	2.99	60.72	29.54	6.48	0.28	0.19
245	1	Q100	Arch -noinef	130.00		94.29	98.31	96.98	98.41	0.001001	4.02	3.63	3.10	66.80	29.96	6.48	0.29	0.20
245	1	Q100	245-Ex	130.00		94.29	98.31	96.98	98.41	0.001001	4.02	3.63	3.10	66.80	29.96	6.48	0.29	0.20
245	2	Lo	Arch -noinef	5.00	49.00	94.29	95.42		95.43	0.000840	1.13	0.79	1.04	4.80	6.07	6.07	0.21	0.04
245	2	Lo	245-Ex	5.00	49.00	94.29	95.42		95.43	0.000840	1.13	0.79	1.04	4.80	6.07	6.07	0.21	0.04
245	2	Lo	Arch -noinef	10.00	49.00	94.29	95.83		95.86	0.000862	1.54	1.15	1.34	7.75	9.32	6.48	0.22	0.05
245	2	Lo	245-Ex	10.00	49.00	94.29	95.83		95.86	0.000862	1.54	1.15	1.34	7.75	9.32	6.48	0.22	0.05
245	2	Q1sh psg 0.4Q2	Arch -noinef	17.00	49.00	94.29	96.20		96.24	0.000879	1.91	1.52	1.63	12.36	15.16	6.48	0.23	0.07
245	2	Q1sh psg 0.4Q2	245-Ex	17.00	49.00	94.29	96.20		96.24	0.000879	1.91	1.52	1.63	12.36	15.16	6.48	0.23	0.07
245	2	Lo	Arch -noinef	30.00	49.00	94.29	96.67		96.73	0.000893	2.38	1.99	1.97	21.20	22.36	6.48	0.25	0.10
245	2	Lo	245-Ex	30.00	49.00	94.29	96.67		96.73	0.000893	2.38	1.99	1.97	21.20	22.36	6.48	0.25	0.10
245	2	Q2	Arch -noinef	42.00	49.00	94.29	96.99		97.05	0.000900	2.70	2.31	2.18	29.09	27.26	6.48	0.25	0.12
245	2	Q2	245-Ex	42.00	49.00	94.29	96.99		97.05	0.000900	2.70	2.31	2.18	29.09	27.26	6.48	0.25	0.12
245	2	Q5	Arch -noinef	64.00	49.00	94.29	97.42		97.48	0.000910	3.13	2.74	2.45	40.85	28.13	6.48	0.26	0.14
245	2	Q5	245-Ex	64.00	49.00	94.29	97.42		97.48	0.000910	3.13	2.74	2.45	40.85	28.13	6.48	0.26	0.14
245	2	Q10	Arch -noinef	79.00	49.00	94.29	97.66		97.74	0.000919	3.37	2.98	2.61	47.80	28.63	6.48	0.27	0.15
245	2	Q10	245-Ex	79.00	49.00	94.29	97.66		97.74	0.000919	3.37	2.98	2.61	47.80	28.63	6.48	0.27	0.15
245	2	Q25	Arch -noinef	99.00	49.00	94.29	97.96		98.04	0.000928	3.67	3.28	2.79	56.32	29.24	6.48	0.27	0.17
245	2	Q25	245-Ex	99.00	49.00	94.29	97.96		98.04	0.000928	3.67	3.28	2.79	56.32	29.24	6.48	0.27	0.17
245	2	Q50	Arch -noinef	114.00	49.00	94.29	98.16		98.24	0.000934	3.87	3.48	2.92	62.28	29.65	6.48	0.28	0.18
245	2	Q50	245-Ex	114.00	49.00	94.29	98.16		98.24	0.000934	3.87	3.48	2.92	62.28	29.65	6.48	0.28	0.18
245	2	Q100	Arch -noinef	130.00	49.00	94.29	98.36		98.45	0.000937	4.07	3.68	3.03	68.39	30.07	6.48	0.28	0.19
245	2	Q100	245-Ex	130.00	49.00	94.29	98.36		98.45	0.000938	4.07	3.68	3.03	68.38	30.07	6.48	0.28	0.19
245	5			Culvert														
245	9	Lo	Arch -noinef	5.00	121.00	95.29	95.77	95.77	95.92	0.026851	0.48	0.29	3.12	1.80	5.44	5.44	1.01	0.46
245	9	Lo	245-Ex	5.00	121.00	95.29	96.94	95.77	96.94	0.000147	1.65	1.35	0.56	8.96	6.90	6.63	0.08	0.01
245	9	Lo	Arch -noinef	10.00	121.00	95.29	95.95	95.95	96.18	0.024210	0.66	0.45	3.83	2.61	5.86	5.86	1.01	0.61
245	9	Lo	245-Ex	10.00	121.00	95.29	97.32	95.95	97.33	0.000252	2.03	0.87	1.73	11.85	8.21	6.63	0.12	0.02
245	9	Q1sh psg 0.4Q2	Arch -noinef	17.00	121.00	95.29	96.15	96.15	96.46	0.022221	0.86	0.61	4.43	3.84	6.33	6.33	1.00	0.74
245	9	Q1sh psg 0.4Q2	245-Ex	17.00	121.00	95.29	97.74	96.15	97.76	0.000339	2.45	2.15	1.16	16.13	12.28	6.63	0.14	0.04
245	9	Lo	Arch -noinef	30.00	121.00	95.29	96.67	96.43	96.94	0.010352	1.38	1.09	4.18	7.18	6.56	6.56	0.70	0.56
245	9	Lo	245-Ex	30.00	121.00	95.29	98.37	96.43	98.40	0.000373	3.08	2.78	1.44	26.50	19.29	6.63	0.15	0.05
245	9	Q2	Arch -noinef	42.00	121.00	95.29	97.07	96.65	97.35	0.007521	1.78	1.48	4.27	9.91	7.36	6.63	0.62	0.54
245	9	Q2	245-Ex	42.00	121.00	95.29	98.89	96.65	98.92	0.000340	3.60	3.30	1.54	37.62	23.58	6.63	0.15	0.05
245	9	Q5	Arch -noinef	64.00	121.00	95.29	97.68	97.01	97.99	0.005310	2.39	2.09	4.51	15.44	11.74	6.63	0.55	0.53
245	9	Q5	245-Ex	64.00	121.00	95.29	99.75	97.01	99.78	0.000260	4.46	4.16	1.58	57.97	23.58	6.63	0.14	0.05
245	9	Q10	Arch -noinef	79.00	121.00	95.29	98.11	97.25	98.40	0.003956	2.82	2.52	4.41	21.66	17.75	6.63	0.49	0.48
245	9	Q10	245-Ex	79.00	121.00	95.29	100.31	97.25	100.34	0.000225	5.02	4.72	1.60	71.13	23.58	6.63	0.13	0.05
245	9	Q25	Arch -noinef	99.00	121.00	95.29	98.75	97.57	98.95	0.002330	3.46	3.16	3.93	34.27	22.94	6.63	0.39	0.35
245	9	Q25	245-Ex	99.00	121.00	95.29	101.18	97.57	101.20	0.000173	5.89	5.59	1.57	91.63	23.58	6.63	0.12	0.05
245	9	Q50	Arch -noinef	114.00	121.00	95.29	99.27	97.79	99.41	0.001476	3.98	3.68	3.46	46.55	23.58	6.63	0.32	0.26
245	9	Q50	245-Ex	114.00	121.00	95.29	101.42	97.79	101.45	0.000193	6.13	5.83	1.70	97.24	23.58	6.63	0.12	0.05
245	9	Q100	Arch -noinef	130.00	121.00	95.29	99.88	98.04	99.99	0.000932	4.59	4.29	3.05	61.05	23.58	6.63	0.26	0.19
245	9	Q100	245-Ex	130.00	121.00	95.29	101.34	98.04	101.38	0.000266	6.05	5.75	1.98	95.33	23.58	6.63	0.15	0.07

HEC-RAS River: Trib 245 Reach: 245 (Continued)

Reach	River Sta	Profile	Plan	Q Total (cfs)	Cum Ch Len (ft)	Min Ch El (ft)	W.S. Elev (ft)	Crit W.S. (ft)	E.G. Elev (ft)	E.G. Slope (ft/ft)	Max Chl Dpth (ft)	Hydr Depth C (ft)	Vel Chnl (ft/s)	Flow Area (sq ft)	Top Width (ft)	Top W Chnl (ft)	Froude # Chl	Shear Chan (lb/sq ft)
245	10	Lo	Arch -noinef	5.00	178.00	95.29	96.17		96.19	0.001802	0.88	0.62	1.27	3.92	6.35	6.35	0.29	0.06
245	10	Lo	245-Ex	5.00	178.00	95.29	96.95		96.95	0.000144	1.66	1.36	0.56	9.01	6.93	6.63	0.08	0.01
245	10	Lo	Arch -noinef	10.00	178.00	95.29	96.45		96.50	0.002247	1.16	0.89	1.74	5.74	6.47	6.47	0.33	0.10
245	10	Lo	245-Ex	10.00	178.00	95.29	97.34		97.35	0.000245	2.05	1.75	0.86	11.97	8.26	6.63	0.11	0.02
245	10	Qfsh psg 0.4Q2	Arch -noinef	17.00	178.00	95.29	96.74		96.82	0.002752	1.45	1.16	2.22	7.65	6.59	6.59	0.36	0.16
245	10	Qfsh psg 0.4Q2	245-Ex	17.00	178.00	95.29	97.76		97.78	0.000328	2.47	2.17	1.15	16.37	12.47	6.63	0.14	0.03
245	10	Lo	Arch -noinef	30.00	178.00	95.29	97.13		97.27	0.003349	1.84	1.54	2.92	10.37	7.57	6.63	0.41	0.25
245	10	Lo	245-Ex	30.00	178.00	95.29	98.40		98.42	0.000360	3.11	2.81	1.43	26.92	19.42	6.63	0.15	0.05
245	10	Q2	Arch -noinef	42.00	178.00	95.29	97.47		97.64	0.003349	2.18	1.88	3.33	13.17	9.72	6.63	0.43	0.30
245	10	Q2	245-Ex	42.00	178.00	95.29	98.91		98.94	0.000330	3.62	3.32	1.53	38.09	23.58	6.63	0.15	0.05
245	10	Q5	Arch -noinef	64.00	178.00	95.29	98.02		98.22	0.003043	2.73	2.43	3.77	19.99	16.36	6.63	0.43	0.35
245	10	Q5	245-Ex	64.00	178.00	95.29	99.77		99.79	0.000256	4.48	4.18	1.57	58.32	23.58	6.63	0.14	0.05
245	10	Q10	Arch -noinef	79.00	178.00	95.29	98.38		98.58	0.002544	3.09	2.79	3.78	26.69	19.35	6.63	0.40	0.34
245	10	Q10	245-Ex	79.00	178.00	95.29	100.32		100.35	0.000223	5.03	4.73	1.59	71.44	23.58	6.63	0.13	0.05
245	10	Q25	Arch -noinef	99.00	178.00	95.29	98.90		99.07	0.001845	3.61	3.31	3.61	37.97	23.58	6.63	0.35	0.29
245	10	Q25	245-Ex	99.00	178.00	95.29	101.19		101.21	0.000171	5.90	5.60	1.56	91.86	23.58	6.63	0.12	0.05
245	10	Q50	Arch -noinef	114.00	178.00	95.29	99.36		99.49	0.001308	4.07	3.77	3.31	48.77	23.58	6.63	0.30	0.24
245	10	Q50	245-Ex	114.00	178.00	95.29	101.43		101.46	0.000192	6.14	5.84	1.70	97.51	23.58	6.63	0.12	0.05
245	10	Q100	Arch -noinef	130.00	178.00	95.29	99.94		100.04	0.000878	4.65	4.35	2.99	62.39	23.58	6.63	0.25	0.18
245	10	Q100	245-Ex	130.00	178.00	95.29	101.35		101.39	0.000263	6.06	5.76	1.97	95.69	23.58	6.63	0.14	0.07

Tributary 319+13 HEC-RAS

Companion 2006 Stream and Habitat Inventory (S&HI) station 342+00
Model based on relative datum. Subtract 68.83-ft for approximate conversion to
ADOT&PF project datum

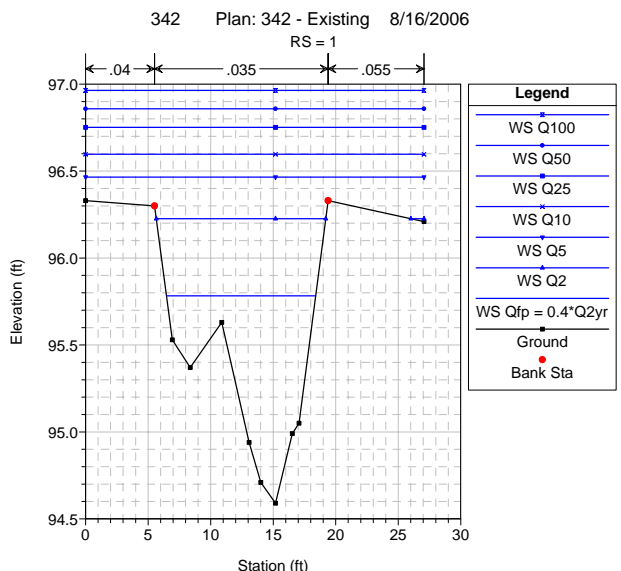
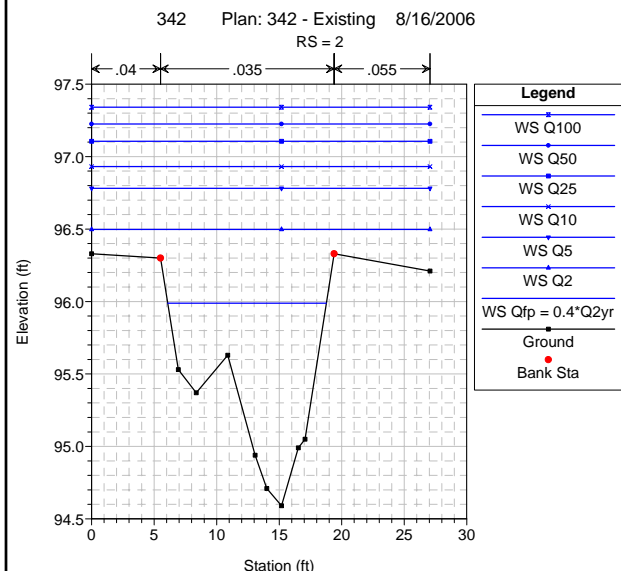
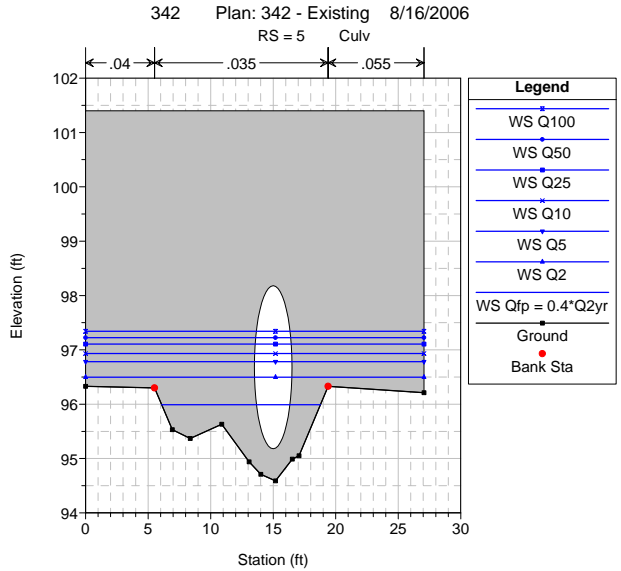
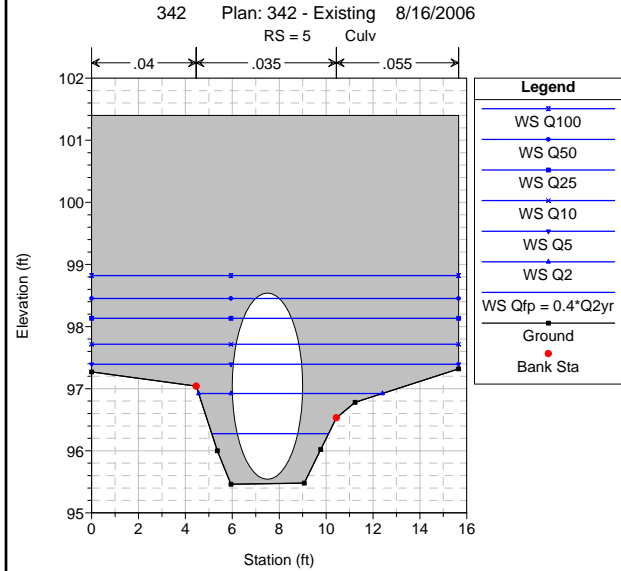
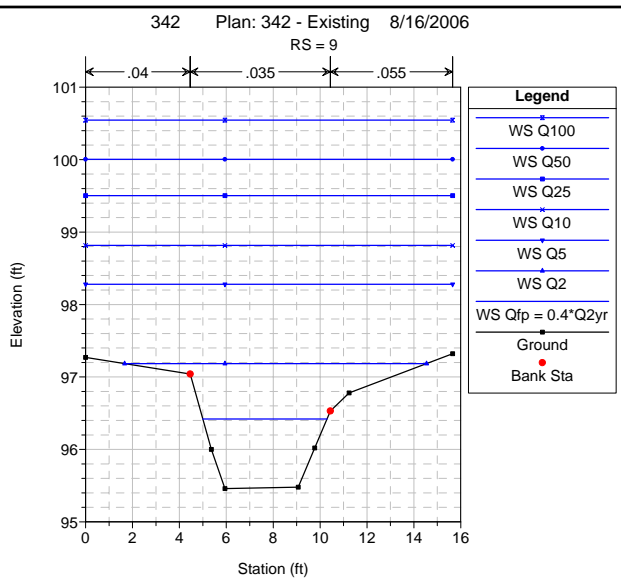
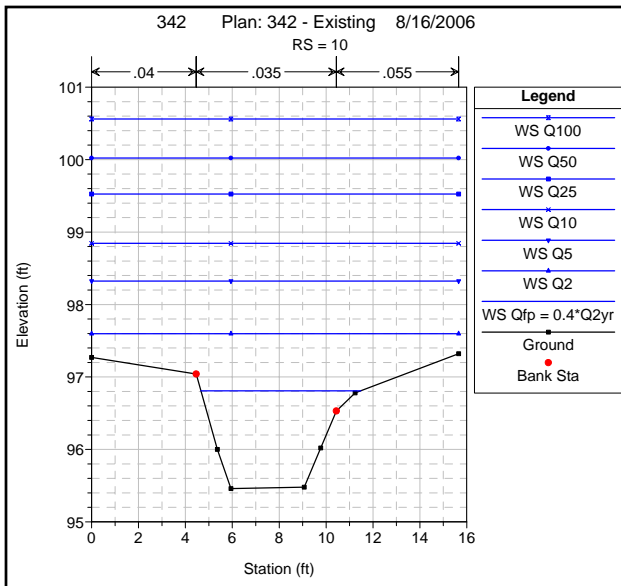

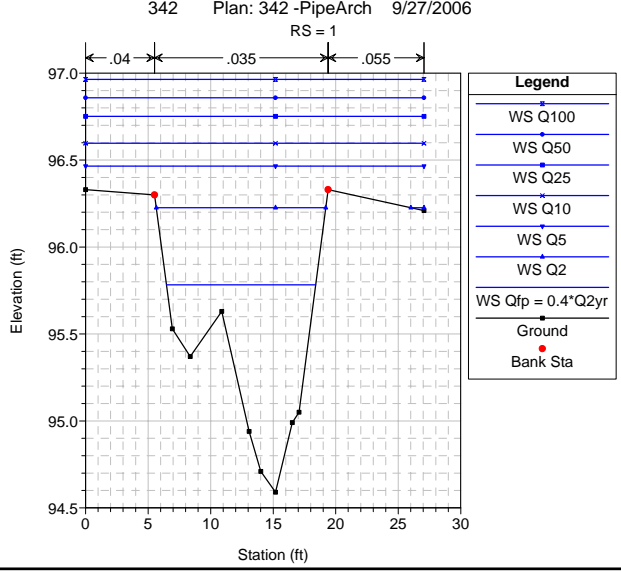
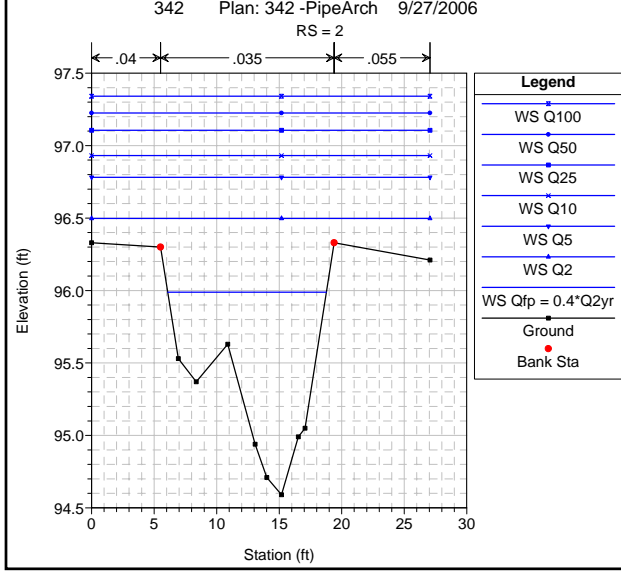
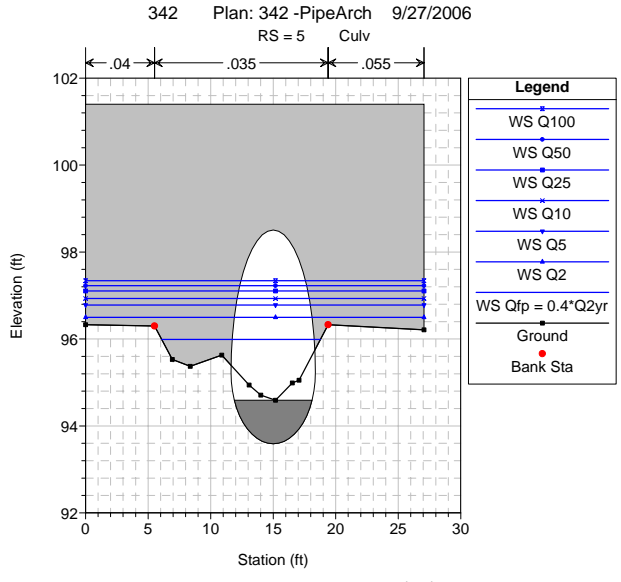
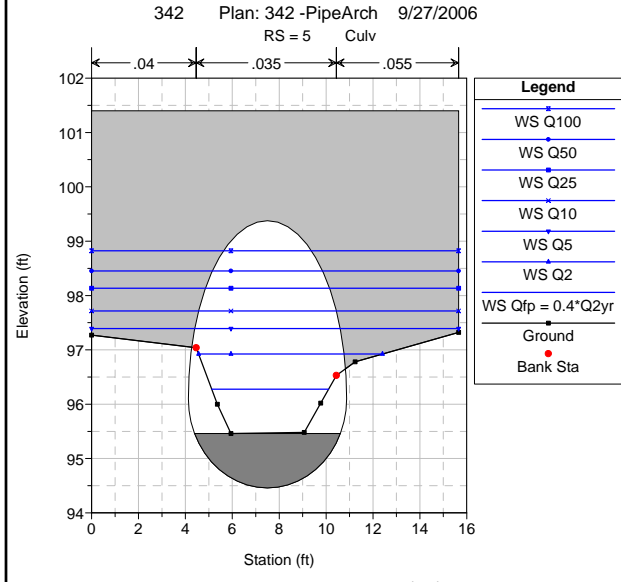
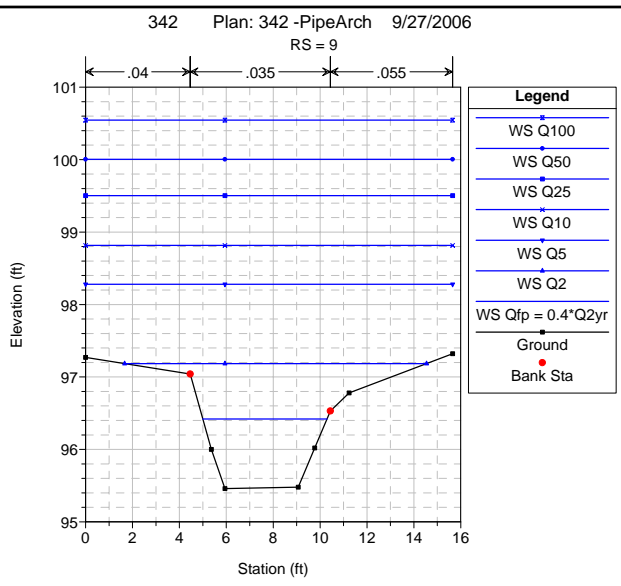
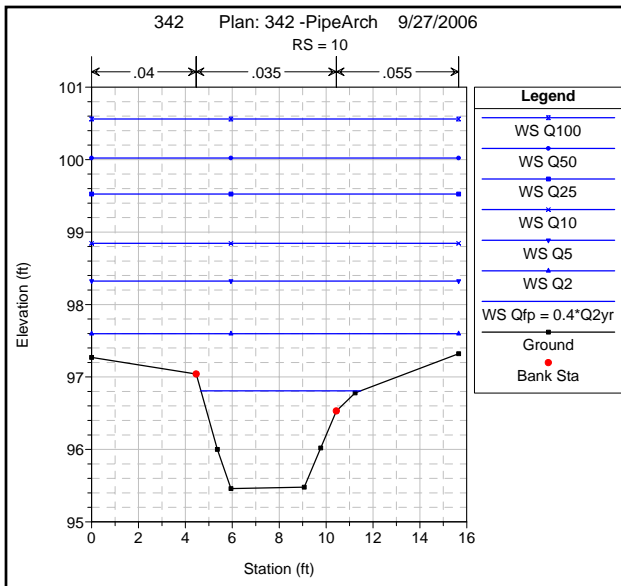

HEC-RAS River: Trib 342 Reach: 342

Reach	River Sta	Profile	Plan	Q Total (cfs)	Cum Ch Len (ft)	Min Ch El (ft)	W.S. Elev (ft)	Crit W.S. (ft)	E.G. Elev (ft)	E.G. Slope (ft/ft)	Max Chl Dpth (ft)	Hydr Depth C (ft)	Vel Chnl (ft/s)	Flow Area (sq ft)	Top Width (ft)	Top W Chnl (ft)	Froude # Chl	Shear Chan (lb/sq ft)
342	1	Lo	342-Sim	10.00		94.59	95.55	95.35	95.64	0.010703	0.96	0.41	2.39	4.19	10.09	10.09	0.65	0.27
342	1	Lo	342-Ex	10.00		94.59	95.55	95.35	95.64	0.010703	0.96	0.41	2.39	4.19	10.09	10.09	0.65	0.27
342	1	Qfp = 0.4*Q2yr	342-Sim	20.00		94.59	95.78	95.64	95.92	0.010703	1.19	0.57	2.94	6.80	11.93	11.93	0.69	0.37
342	1	Qfp = 0.4*Q2yr	342-Ex	20.00		94.59	95.78	95.64	95.92	0.010703	1.19	0.57	2.94	6.80	11.93	11.93	0.69	0.37
342	1	Lo	342-Sim	30.00		94.59	95.95	95.79	96.13	0.010719	1.36	0.71	3.39	8.86	12.54	12.54	0.71	0.45
342	1	Lo	342-Ex	30.00		94.59	95.95	95.79	96.13	0.010719	1.36	0.71	3.39	8.86	12.54	12.54	0.71	0.45
342	1	Lo	342-Sim	40.00		94.59	96.10	95.92	96.31	0.010701	1.51	0.82	3.73	10.73	13.08	13.08	0.73	0.52
342	1	Lo	342-Ex	40.00		94.59	96.10	95.92	96.31	0.010701	1.51	0.82	3.73	10.73	13.08	13.08	0.73	0.52
342	1	Q2	342-Sim	50.00		94.59	96.23	96.03	96.48	0.010708	1.64	0.92	4.02	12.46	14.60	13.55	0.74	0.58
342	1	Q2	342-Ex	50.00		94.59	96.23	96.03	96.48	0.010708	1.64	0.92	4.02	12.46	14.60	13.55	0.74	0.58
342	1	Q5	342-Sim	75.00		94.59	96.47	96.37	96.79	0.010709	1.88	1.14	4.62	18.08	27.06	13.87	0.76	0.72
342	1	Q5	342-Ex	75.00		94.59	96.47	96.37	96.79	0.010709	1.88	1.14	4.62	18.08	27.06	13.87	0.76	0.72
342	1	Q10	342-Sim	93.00		94.59	96.60	96.53	96.96	0.010705	2.01	1.27	4.97	21.64	27.06	13.87	0.78	0.80
342	1	Q10	342-Ex	93.00		94.59	96.60	96.53	96.96	0.010705	2.01	1.27	4.97	21.64	27.06	13.87	0.78	0.80
342	1	Q25	342-Sim	117.00		94.59	96.75	96.69	97.16	0.010716	2.16	1.42	5.37	25.83	27.06	13.87	0.79	0.90
342	1	Q25	342-Ex	117.00		94.59	96.75	96.69	97.16	0.010716	2.16	1.42	5.37	25.83	27.06	13.87	0.79	0.90
342	1	Q50	342-Sim	135.00		94.59	96.86	96.79	97.30	0.010712	2.27	1.53	5.63	28.72	27.06	13.87	0.80	0.97
342	1	Q50	342-Ex	135.00		94.59	96.86	96.79	97.30	0.010712	2.27	1.53	5.63	28.72	27.06	13.87	0.80	0.97
342	1	Q100	342-Sim	154.00		94.59	96.96	96.88	97.44	0.010710	2.37	1.63	5.89	31.58	27.06	13.87	0.81	1.04
342	1	Q100	342-Ex	154.00		94.59	96.96	96.88	97.44	0.010710	2.37	1.63	5.89	31.58	27.06	13.87	0.81	1.04
342	2	Lo	342-Sim	10.00	22.00	94.59	95.73		95.77	0.003570	1.14	0.53	1.61	6.19	11.74	11.74	0.39	0.11
342	2	Lo	342-Ex	10.00	22.00	94.59	95.73		95.77	0.003570	1.14	0.53	1.61	6.19	11.74	11.74	0.39	0.11
342	2	Qfp = 0.4*Q2yr	342-Sim	20.00	22.00	94.59	95.99		96.06	0.004077	1.40	0.74	2.14	9.33	12.68	12.68	0.44	0.18
342	2	Qfp = 0.4*Q2yr	342-Ex	20.00	22.00	94.59	95.99		96.06	0.004063	1.40	0.74	2.14	9.34	12.68	12.68	0.44	0.18
342	2	Lo	342-Sim	30.00	22.00	94.59	96.18		96.28	0.004458	1.59	0.89	2.53	11.86	13.39	13.39	0.47	0.23
342	2	Lo	342-Ex	30.00	22.00	94.59	96.18		96.28	0.004457	1.59	0.89	2.53	11.86	13.39	13.39	0.47	0.23
342	2	Lo	342-Sim	40.00	22.00	94.59	96.35		96.47	0.004611	1.76	1.02	2.82	14.89	27.06	13.87	0.49	0.28
342	2	Lo	342-Ex	40.00	22.00	94.59	96.35		96.47	0.004610	1.76	1.02	2.82	14.89	27.06	13.87	0.49	0.28
342	2	Q2	342-Sim	50.00	22.00	94.59	96.50		96.63	0.004267	1.91	1.17	2.97	18.95	27.06	13.87	0.48	0.30
342	2	Q2	342-Ex	50.00	22.00	94.59	96.50		96.63	0.004260	1.91	1.17	2.97	18.97	27.06	13.87	0.48	0.29
342	2	Q5	342-Sim	75.00	22.00	94.59	96.78		96.94	0.004055	2.19	1.45	3.35	26.64	27.06	13.87	0.49	0.35
342	2	Q5	342-Ex	75.00	22.00	94.59	96.78		96.94	0.004062	2.19	1.45	3.35	26.62	27.06	13.87	0.49	0.35
342	2	Q10	342-Sim	93.00	22.00	94.59	96.93		97.12	0.004225	2.34	1.60	3.65	30.70	27.06	13.87	0.51	0.40
342	2	Q10	342-Ex	93.00	22.00	94.59	96.93		97.12	0.004228	2.34	1.60	3.65	30.69	27.06	13.87	0.51	0.40
342	2	Q25	342-Sim	117.00	22.00	94.59	97.11		97.33	0.004461	2.52	1.78	4.02	35.43	27.06	13.87	0.53	0.47
342	2	Q25	342-Ex	117.00	22.00	94.59	97.11		97.32	0.004465	2.52	1.78	4.02	35.41	27.06	13.87	0.53	0.47
342	2	Q50	342-Sim	135.00	22.00	94.59	97.22		97.47	0.004627	2.63	1.89	4.27	38.63	27.06	13.87	0.55	0.52
342	2	Q50	342-Ex	135.00	22.00	94.59	97.22		97.47	0.004631	2.63	1.89	4.27	38.61	27.06	13.87	0.55	0.52
342	2	Q100	342-Sim	154.00	22.00	94.59	97.34		97.61	0.004787	2.75	2.01	4.52	41.78	27.06	13.87	0.56	0.57
342	2	Q100	342-Ex	154.00	22.00	94.59	97.34		97.61	0.004791	2.75	2.01	4.52	41.77	27.06	13.87	0.56	0.57
342	5			Culvert														
342	9	Lo	342-Sim	10.00	77.00	95.46	96.09	96.09	96.36	0.025408	0.63	0.53	4.14	2.42	4.59	4.59	1.00	0.76
342	9	Lo	342-Ex	10.00	77.00	95.46	97.14	96.09	97.16	0.006647	1.68	1.36	1.19	9.18	11.69	5.98	0.18	0.05
342	9	Qfp = 0.4*Q2yr	342-Sim	20.00	77.00	95.46	96.42	96.42	96.80	0.023537	0.96	0.76	4.98	4.02	5.30	5.30	1.01	0.98
342	9	Qfp = 0.4*Q2yr	342-Ex	20.00	77.00	95.46	97.91	96.42	97.93	0.000385	2.45	2.14	1.24	21.00	15.65	5.98	0.15	0.04
342	9	Lo	342-Sim	30.00	77.00	95.46	96.67	96.67	97.15	0.021856	1.21	0.96	5.54	5.45	6.12	5.66	1.00	1.13
342	9	Lo	342-Ex	30.00	77.00	95.46	98.59	96.67	98.61	0.000278	3.13	2.81	1.27	31.57	15.65	5.98	0.13	0.04
342	9	Lo	342-Sim	40.00	77.00	95.46	96.90	96.90	97.44	0.019710	1.44	1.15	5.90	6.99	7.65	5.86	0.97	1.21
342	9	Lo	342-Ex	40.00	77.00	95.46	99.29	96.90	99.31	0.000210	3.83	3.51	1.28	42.48	15.65	5.98	0.12	0.04
342	9	Q2	342-Sim	50.00	77.00	95.46	97.18	97.13	97.68	0.014403	1.72	1.41	5.75	9.71	12.87	5.98	0.85	1.08
342	9	Q2	342-Ex	50.00	77.00	95.46	100.31	97.13	100.32	0.000130	4.85	4.53	1.19	58.44	15.65	5.98	0.10	0.03
342	9	Q5	342-Sim	75.00	77.00	95.46	98.28	97.56	98.45	0.002794	2.82	2.50	3.72	26.70	15.65	5.98	0.41	0.37
342	9	Q5	342-Ex	75.00	77.00	95.46	101.83	97.56	101.85	0.000108	6.37	6.05	1.32	82.29	15.65	5.98	0.09	0.03
342	9	Q10	342-Sim	93.00	77.00	95.46	98.82	97.73	98.97	0.001974	3.36	3.04	3.56	35.10	15.65	5.98	0.36	0.32
342	9	Q10	342-Ex	93.00	77.00	95.46	102.16	97.73	102.18	0.000139	6.70	6.38	1.55	87.38	15.65	5.98	0.11	0.05
342	9	Q25	342-Sim	117.00	77.00	95.46	99.50	97.93	99.64	0.001441	4.04	3.73	3.48	45.86	15.65	5.98	0.32	0.29
342	9	Q25	342-Ex	117.00	77.00	95.46	102.51	97.93	102.55	0.000184	7.05	6.73	1.85	92.91	15.65	5.98	0.13	0.07
342	9	Q50	342-Sim	135.00	77.00	95.46	100.00	98.07	100.14	0.001211	4.54	4.23	3.47	53.71	15.65	5.98	0.30	0.27
342	9	Q50	342-Ex	135.00	77.00	95.46	102.74	98.07	102.78	0.000220	7.28	6.96	2.06	96.44	15.65	5.98	0.14	0.08

HEC-RAS River: Trib 342 Reach: 342 (Continued)

Reach	River Sta	Profile	Plan	Q Total (cfs)	Cum Ch Len (ft)	Min Ch El (ft)	W.S. Elev (ft)	Crit W.S. (ft)	E.G. Elev (ft)	E.G. Slope (ft/ft)	Max Chl Dpth (ft)	Hydr Depth C (ft)	Vel Chnl (ft/s)	Flow Area (sq ft)	Top Width (ft)	Top W Chnl (ft)	Froude # Chl	Shear Chan (lb/sq ft)
342	9	Q100	342-Sim	154.00	77.00	95.46	100.55	98.20	100.68	0.001029	5.09	4.77	3.47	62.18	15.65	5.98	0.28	0.26
342	9	Q100	342-Ex	154.00	77.00	95.46	102.97	98.20	103.03	0.000257	7.51	7.19	2.28	100.12	15.65	5.98	0.15	0.10
342	10	Lo	342-Sim	10.00	90.00	95.46	96.42		96.52	0.005847	0.96	0.76	2.48	4.03	5.30	5.30	0.50	0.24
342	10	Lo	342-Ex	10.00	90.00	95.46	97.15		97.17	0.000632	1.69	1.37	1.18	9.29	11.93	5.98	0.18	0.05
342	10	Q1p = 0.4*Q2yr	342-Sim	20.00	90.00	95.46	96.81		96.97	0.006377	1.35	1.07	3.21	6.33	6.82	5.78	0.55	0.37
342	10	Q1p = 0.4*Q2yr	342-Ex	20.00	90.00	95.46	97.92		97.94	0.000381	2.46	2.14	1.24	21.08	15.65	5.98	0.15	0.04
342	10	Lo	342-Sim	30.00	90.00	95.46	97.11		97.31	0.006383	1.65	1.33	3.69	8.80	10.76	5.98	0.56	0.45
342	10	Lo	342-Ex	30.00	90.00	95.46	98.59		98.61	0.000277	3.13	2.82	1.27	31.63	15.65	5.98	0.13	0.04
342	10	Lo	342-Sim	40.00	90.00	95.46	97.38	96.90	97.59	0.005468	1.92	1.60	3.86	12.57	15.65	5.98	0.54	0.47
342	10	Lo	342-Ex	40.00	90.00	95.46	99.29		99.31	0.000210	3.83	3.51	1.28	42.52	15.65	5.98	0.12	0.04
342	10	Q2	342-Sim	50.00	90.00	95.46	97.60	97.13	97.81	0.004843	2.14	1.82	3.96	16.03	15.65	5.98	0.52	0.47
342	10	Q2	342-Ex	50.00	90.00	95.46	100.31		100.32	0.000130	4.85	4.53	1.19	58.46	15.65	5.98	0.10	0.03
342	10	Q5	342-Sim	75.00	90.00	95.46	98.32		98.49	0.002599	2.86	2.55	3.63	27.40	15.65	5.98	0.40	0.35
342	10	Q5	342-Ex	75.00	90.00	95.46	101.83		101.85	0.000108	6.37	6.06	1.32	82.31	15.65	5.98	0.09	0.03
342	10	Q10	342-Sim	93.00	90.00	95.46	98.85		98.99	0.001901	3.39	3.07	3.51	35.56	15.65	5.98	0.35	0.31
342	10	Q10	342-Ex	93.00	90.00	95.46	102.16		102.18	0.000139	6.70	6.38	1.55	87.41	15.65	5.98	0.11	0.05
342	10	Q25	342-Sim	117.00	90.00	95.46	99.52		99.66	0.001412	4.06	3.75	3.46	46.18	15.65	5.98	0.31	0.28
342	10	Q25	342-Ex	117.00	90.00	95.46	102.51		102.55	0.000184	7.05	6.74	1.85	92.95	15.65	5.98	0.13	0.07
342	10	Q50	342-Sim	135.00	90.00	95.46	100.02		100.16	0.001194	4.56	4.25	3.46	53.98	15.65	5.98	0.30	0.27
342	10	Q50	342-Ex	135.00	90.00	95.46	102.74		102.78	0.000220	7.28	6.96	2.06	96.48	15.65	5.98	0.14	0.08
342	10	Q100	342-Sim	154.00	90.00	95.46	100.56		100.69	0.001018	5.10	4.78	3.45	62.40	15.65	5.98	0.28	0.26
342	10	Q100	342-Ex	154.00	90.00	95.46	102.97		103.03	0.000257	7.51	7.20	2.28	100.17	15.65	5.98	0.15	0.10

Tributary 324+79 HEC-RAS

Companion 2006 Stream and Habitat Inventory (S&HI) station 347+50
Model based on relative datum. Subtract 69.17-ft for approximate conversion to
ADOT&PF project datum

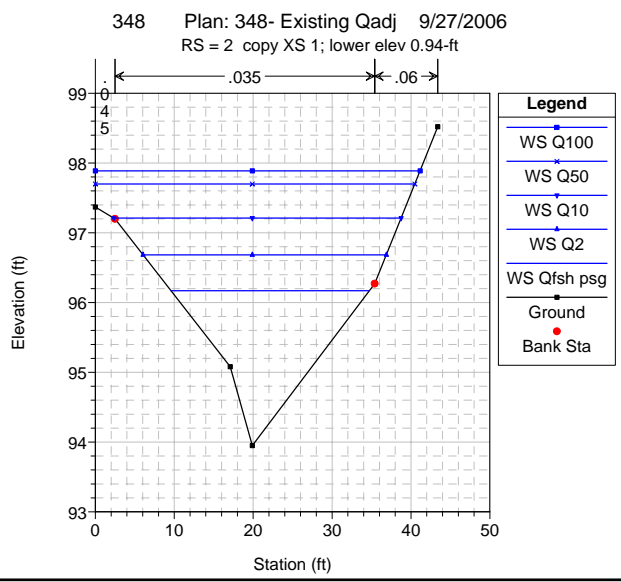
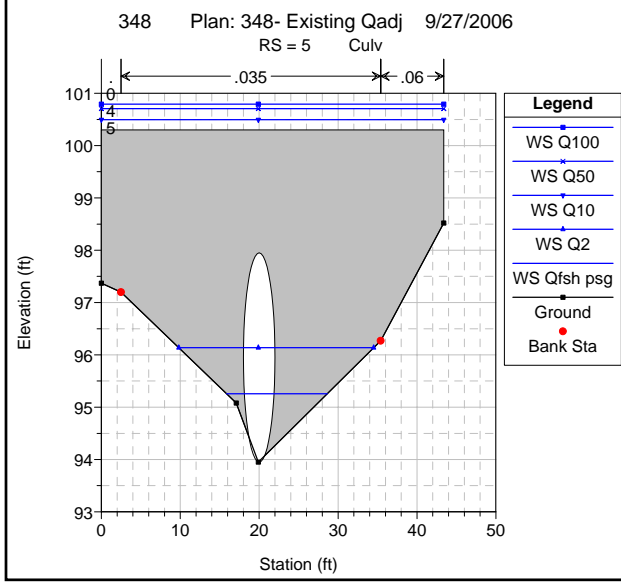
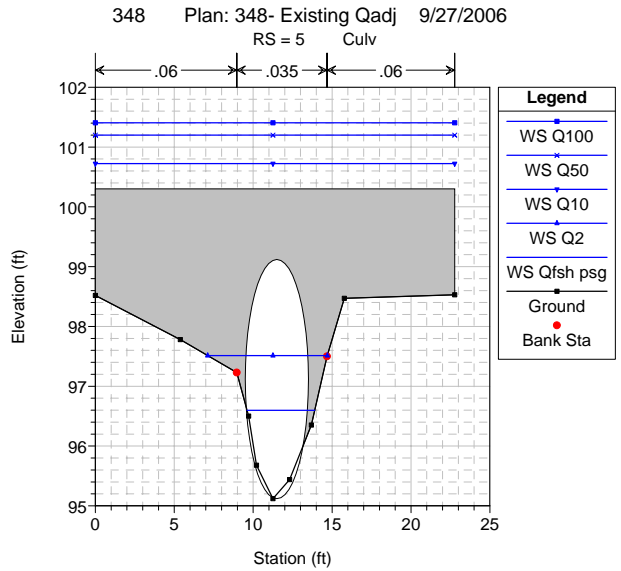
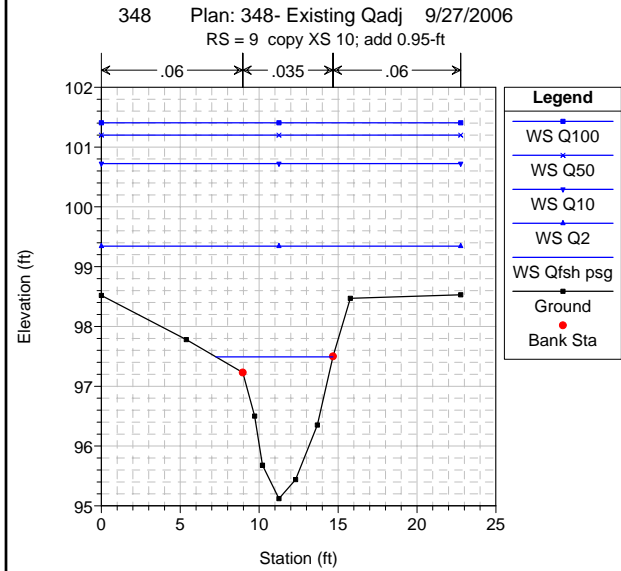
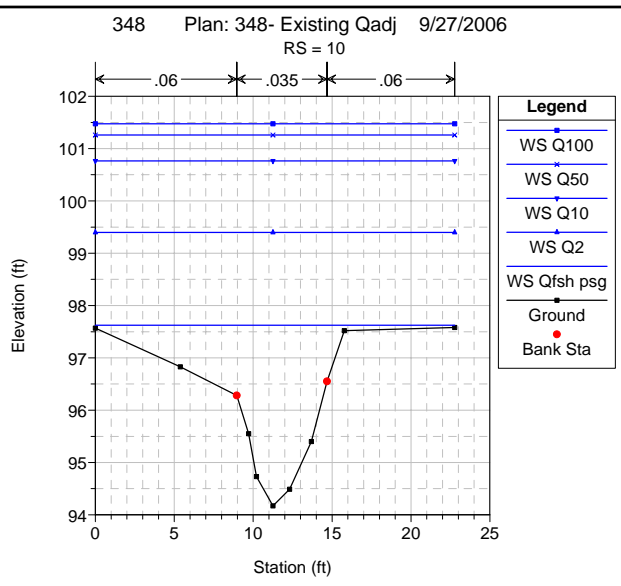
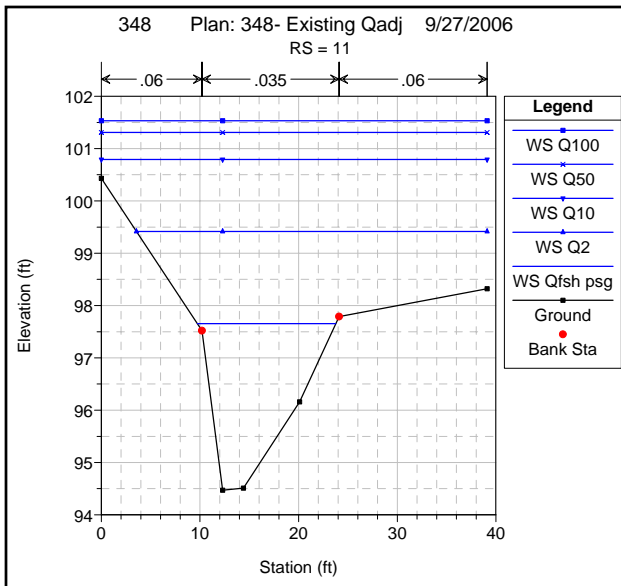

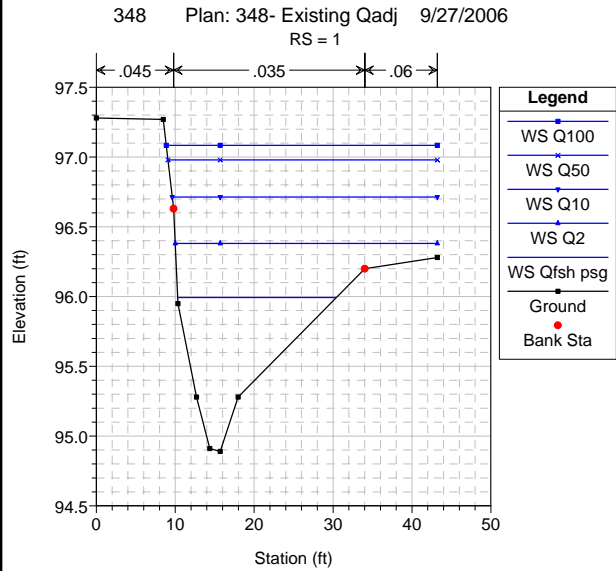
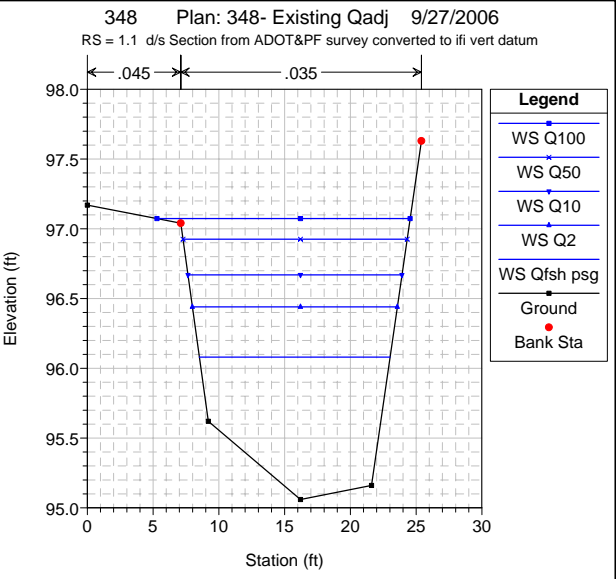
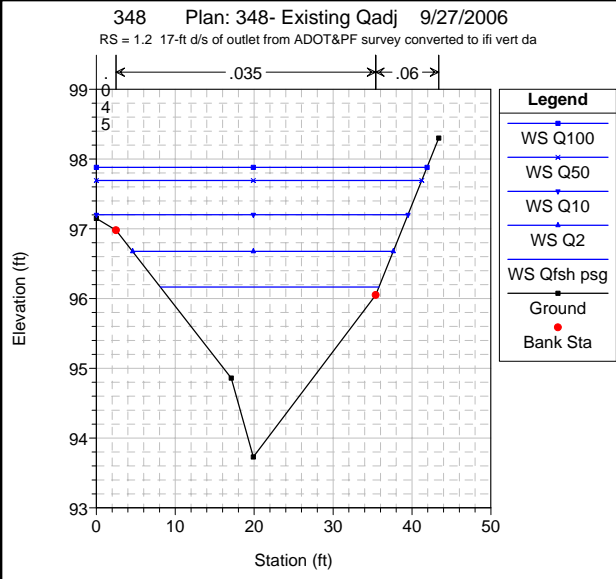

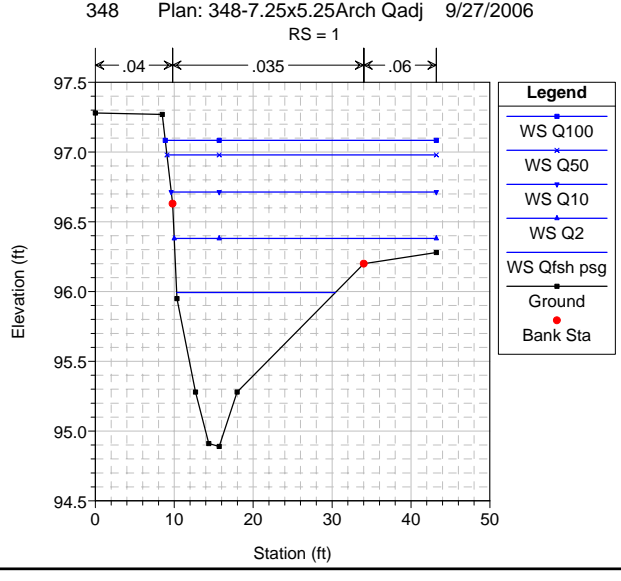
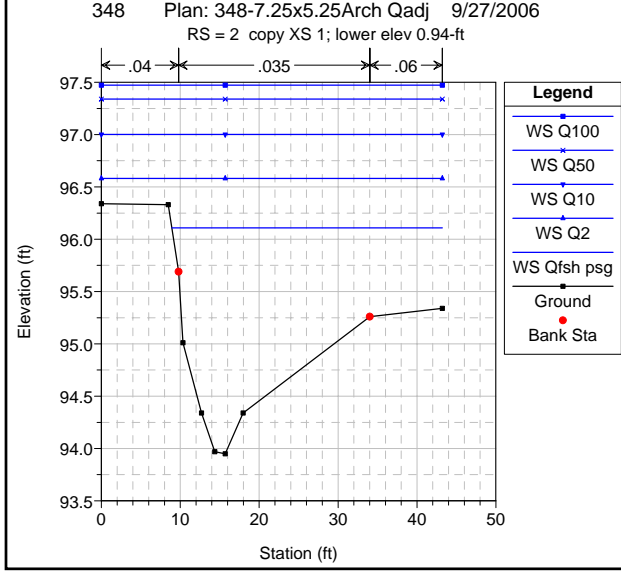
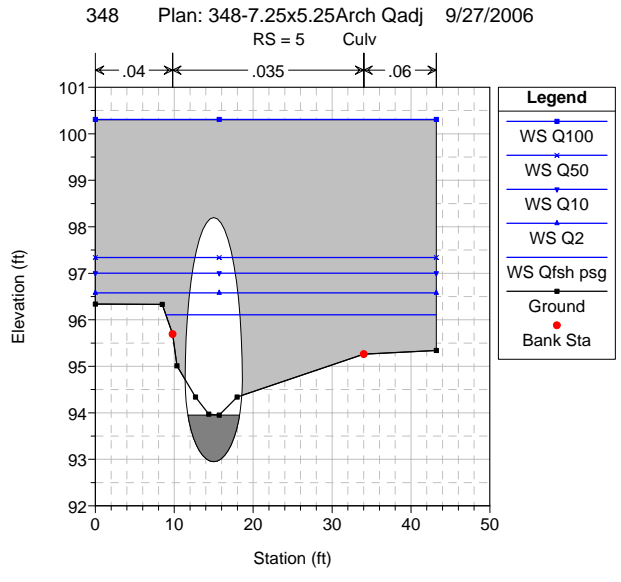
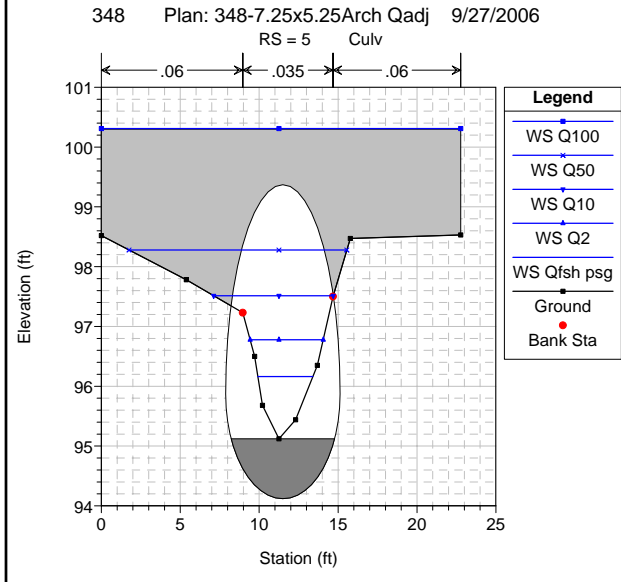
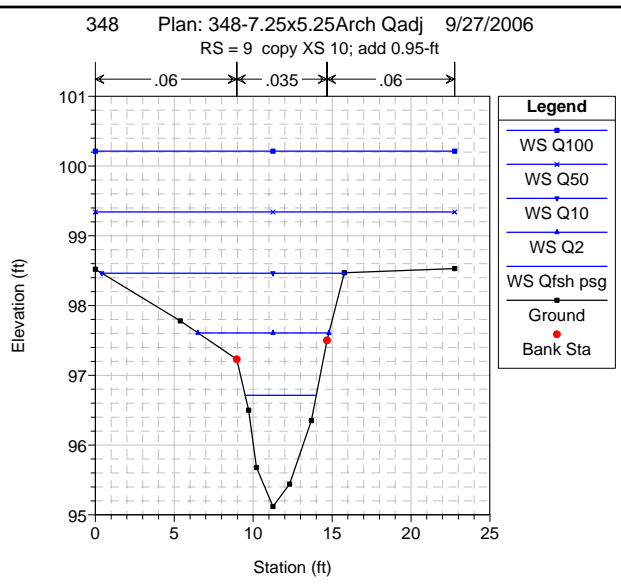
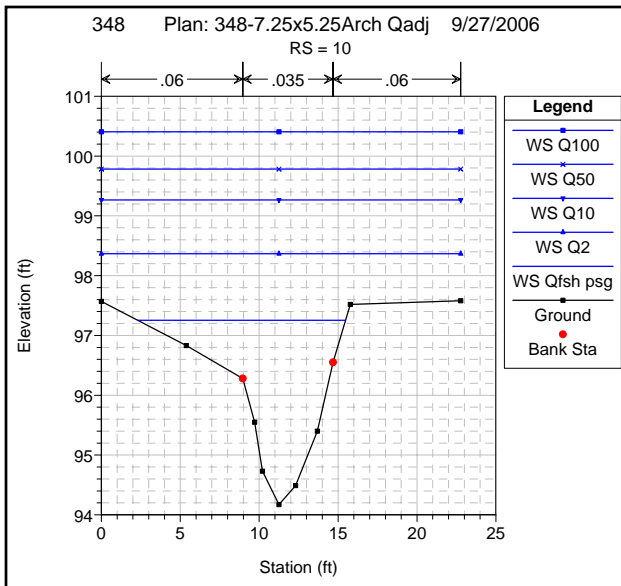

HEC-RAS River: 348 Trib Reach: 348

Reach	River Sta	Profile	Plan	Q Total (cfs)	Cum Ch Len (ft)	Min Ch El (ft)	W.S. Elev (ft)	Crit W.S. (ft)	E.G. Elev (ft)	E.G. Slope (ft/ft)	Max Chl Dpth (ft)	Hydr Depth C (ft)	Vel Chnl (ft/s)	Flow Area (sq ft)	Top Width (ft)	Top W Chnl (ft)	Froude # Chl	Shear Chan (lb/sq ft)
348	1	Qfsh psg	348-7.25Qadj	25.00		94.89	95.99	95.79	96.08	0.008009	1.10	0.51	2.42	10.33	20.09	20.09	0.60	0.25
348	1	Qfsh psg	348exQadj	25.00		94.89	95.99	95.79	96.08	0.008009	1.10	0.51	2.42	10.33	20.09	20.09	0.60	0.25
348	1	Q2	348-7.25Qadj	63.00		94.89	96.38	96.16	96.54	0.008010	1.49	0.80	3.24	20.51	33.21	24.03	0.64	0.39
348	1	Q2	348exQadj	63.00		94.89	96.38	96.16	96.54	0.008010	1.49	0.80	3.24	20.51	33.21	24.03	0.64	0.39
348	1	Q10	348-7.25Qadj	116.00		94.89	96.71	96.49	96.96	0.008001	1.82	1.12	4.05	31.60	33.59	24.24	0.67	0.55
348	1	Q10	348exQadj	116.00		94.89	96.71	96.49	96.96	0.008001	1.82	1.12	4.05	31.60	33.59	24.24	0.67	0.55
348	1	Q50	348-7.25Qadj	169.00		94.89	96.98	96.73	97.30	0.008000	2.09	1.39	4.66	40.61	34.13	24.24	0.70	0.68
348	1	Q50	348exQadj	169.00		94.89	96.98	96.73	97.30	0.008000	2.09	1.39	4.66	40.61	34.14	24.24	0.70	0.68
348	1	Q100	348-7.25Qadj	192.00		94.89	97.08	96.81	97.43	0.008001	2.19	1.49	4.89	44.17	34.35	24.24	0.71	0.73
348	1	Q100	348exQadj	192.00		94.89	97.08	96.82	97.43	0.008001	2.19	1.49	4.89	44.18	34.35	24.24	0.71	0.73
348	1.1	Qfsh psg	348exQadj	25.00	13.10	95.06	96.08		96.16	0.004020	1.02	0.77	2.23	11.23	14.50	14.50	0.45	0.19
348	1.1	Q2	348exQadj	63.00	13.10	95.06	96.44		96.66	0.007680	1.38	1.07	3.78	16.65	15.58	15.58	0.65	0.49
348	1.1	Q10	348exQadj	116.00	13.10	95.06	96.67	96.57	97.18	0.014375	1.61	1.25	5.71	20.30	16.28	16.28	0.90	1.07
348	1.1	Q50	348exQadj	169.00	13.10	95.06	96.93	96.93	97.66	0.017362	1.87	1.44	6.88	24.55	17.05	17.05	1.01	1.48
348	1.1	Q100	348exQadj	192.00	13.10	95.06	97.07	97.07	97.85	0.016686	2.01	1.55	7.08	27.14	19.25	17.44	1.00	1.53
348	1.2	Qfsh psg	348exQadj	25.00	28.10	93.73	96.17		96.18	0.000316	2.44	1.13	0.81	30.90	27.70	27.29	0.13	0.02
348	1.2	Q2	348exQadj	63.00	28.10	93.73	96.68		96.71	0.000633	2.95	1.48	1.37	46.40	33.03	30.81	0.20	0.06
348	1.2	Q10	348exQadj	116.00	28.10	93.73	97.20		97.25	0.000804	3.47	1.91	1.83	65.41	39.50	32.90	0.23	0.09
348	1.2	Q50	348exQadj	169.00	28.10	93.73	97.69		97.76	0.000777	3.96	2.40	2.10	85.20	41.24	32.90	0.24	0.11
348	1.2	Q100	348exQadj	192.00	28.10	93.73	97.88		97.95	0.000772	4.15	2.58	2.20	93.03	41.91	32.90	0.24	0.12
348	2	Qfsh psg	348-7.25Qadj	25.00	48.00	93.95	96.11		96.11	0.000148	2.16	1.46	0.65	42.96	34.28	24.24	0.10	0.01
348	2	Qfsh psg	348exQadj	25.00	48.10	93.95	96.17		96.19	0.000558	2.22	1.00	0.99	25.19	25.14	25.14	0.17	0.03
348	2	Q2	348-7.25Qadj	63.00	48.00	93.95	96.58		96.60	0.000343	2.63	1.93	1.20	61.41	43.21	24.24	0.15	0.04
348	2	Q2	348exQadj	63.00	48.10	93.95	96.68		96.72	0.000983	2.73	1.34	1.60	39.64	30.82	29.35	0.24	0.08
348	2	Q10	348-7.25Qadj	116.00	48.00	93.95	97.00		97.04	0.000558	3.05	2.35	1.75	79.61	43.21	24.24	0.20	0.08
348	2	Q10	348exQadj	116.00	48.10	93.95	97.21		97.28	0.001196	3.26	1.70	2.07	57.36	36.42	32.90	0.28	0.12
348	2	Q50	348-7.25Qadj	169.00	48.00	93.95	97.34		97.40	0.000719	3.39	2.69	2.17	94.22	43.21	24.24	0.23	0.12
348	2	Q50	348exQadj	169.00	48.10	93.95	97.70		97.78	0.001070	3.75	2.18	2.31	76.53	40.49	32.90	0.28	0.14
348	2	Q100	348-7.25Qadj	192.00	48.00	93.95	97.47		97.55	0.000778	3.52	2.82	2.33	99.93	43.21	24.24	0.24	0.13
348	2	Q100	348exQadj	192.00	48.10	93.95	97.89		97.98	0.001039	3.94	2.37	2.41	84.19	41.15	32.90	0.28	0.15
348	5																	
				Culvert														
348	9	Qfsh psg	348-7.25Qadj	25.00	111.00	95.12	96.71	96.71	97.21	0.025040	1.59	0.98	5.67	4.41	4.51	4.51	1.01	1.21
348	9	Qfsh psg	348exQadj	25.00	111.10	95.12	97.49	96.71	97.63	0.004077	2.37	1.48	2.95	8.67	7.41	5.71	0.43	0.29
348	9	Q2	348-7.25Qadj	63.00	111.00	95.12	97.61	97.61	98.33	0.019952	2.49	1.59	6.85	9.59	8.30	5.72	0.96	1.52
348	9	Q2	348exQadj	63.00	111.10	95.12	99.34	97.61	99.41	0.000943	4.22	3.33	2.43	39.40	22.77	5.72	0.24	0.15
348	9	Q10	348-7.25Qadj	116.00	111.00	95.12	98.46	98.46	99.26	0.013401	3.34	2.45	7.48	19.67	15.36	5.72	0.84	1.57
348	9	Q10	348exQadj	116.00	111.10	95.12	100.72	98.48	100.79	0.000684	5.60	4.71	2.61	70.86	22.77	5.72	0.21	0.15
348	9	Q50	348-7.25Qadj	169.00	111.00	95.12	99.34	99.04	99.85	0.006794	4.22	3.33	6.53	39.38	22.77	5.72	0.63	1.08
348	9	Q50	348exQadj	169.00	111.10	95.12	101.20	99.04	101.31	0.000977	6.08	5.19	3.33	81.71	22.77	5.72	0.26	0.24
348	9	Q100	348-7.25Qadj	192.00	111.00	95.12	100.21	99.18	100.50	0.003052	5.09	4.20	5.11	59.25	22.77	5.72	0.44	0.61
348	9	Q100	348exQadj	192.00	111.10	95.12	101.41	99.18	101.54	0.001079	6.29	5.39	3.59	86.41	22.77	5.72	0.27	0.28
348	10	Qfsh psg	348-7.25Qadj	25.00	128.00	94.17	97.25		97.30	0.000975	3.08	2.19	1.87	15.95	13.17	5.72	0.22	0.10
348	10	Qfsh psg	348exQadj	25.00	128.10	94.17	97.62		97.65	0.000520	3.45	2.56	1.52	21.89	22.77	5.72	0.17	0.06
348	10	Q2	348-7.25Qadj	63.00	128.00	94.17	98.37		98.44	0.000977	4.20	3.30	2.46	38.84	22.77	5.72	0.24	0.15
348	10	Q2	348exQadj	63.00	128.10	94.17	99.40		99.43	0.000287	5.23	4.33	1.60	62.30	22.77	5.72	0.14	0.06
348	10	Q10	348-7.25Qadj	116.00	128.00	94.17	99.27		99.37	0.001111	5.10	4.20	3.09	59.32	22.77	5.72	0.27	0.22
348	10	Q10	348exQadj	116.00	128.10	94.17	100.76		100.80	0.000316	6.59	5.70	2.02	93.42	22.77	5.72	0.15	0.09
348	10	Q50	348-7.25Qadj	169.00	128.00	94.17	99.78		99.93	0.001441	5.61	4.72	3.80	71.04	22.77	5.72	0.31	0.33
348	10	Q50	348exQadj	169.00	128.10	94.17	101.26		101.33	0.000487	7.09	6.20	2.65	104.70	22.77	5.72	0.19	0.14
348	10	Q100	348-7.25Qadj	192.00	128.00	94.17	100.41		100.54	0.001119	6.24	5.34	3.63	85.28	22.77	5.72	0.28	0.29
348	10	Q100	348exQadj	192.00	128.10	94.17	101.47		101.55	0.000553	7.30	6.41	2.88	109.56	22.77	5.72	0.20	0.17
348	11	Qfsh psg	348exQadj	25.00	161.10	94.47	97.65		97.67	0.000259	3.18	1.92	0.96	26.12	14.04	13.57	0.12	0.03
348	11	Q2	348exQadj	63.00	161.10	94.47	99.42		99.43	0.000139	4.95	3.64	1.07	77.30	35.55	13.90	0.10	0.03
348	11	Q10	348exQadj	116.00	161.10	94.47	100.79		100.81	0.000126	6.32	5.01	1.27	129.32	39.10	13.90	0.10	0.03

HEC-RAS River: 348 Trib Reach: 348 (Continued)

Reach	River Sta	Profile	Plan	Q Total (cfs)	Cum Ch Len (ft)	Min Ch El (ft)	W.S. Elev (ft)	Crit W.S. (ft)	E.G. Elev (ft)	E.G. Slope (ft/ft)	Max Chl Dpth (ft)	Hydr Depth C (ft)	Vel Chnl (ft/s)	Flow Area (sq ft)	Top Width (ft)	Top W Chnl (ft)	Froude # Chl	Shear Chan (lb/sq ft)
348	11	Q50	348exQadj	169.00	161.10	94.47	101.31		101.34	0.000180	6.84	5.53	1.62	149.51	39.10	13.90	0.12	0.05
348	11	Q100	348exQadj	192.00	161.10	94.47	101.53		101.57	0.000199	7.06	5.75	1.75	158.22	39.10	13.90	0.13	0.06

Tributary 483+18 HEC-RAS

Companion 2006 Stream and Habitat Inventory (S&HI) station 506+25
Model based on relative datum. Subtract 57.63-ft for approximate conversion to
ADOT&PF project datum

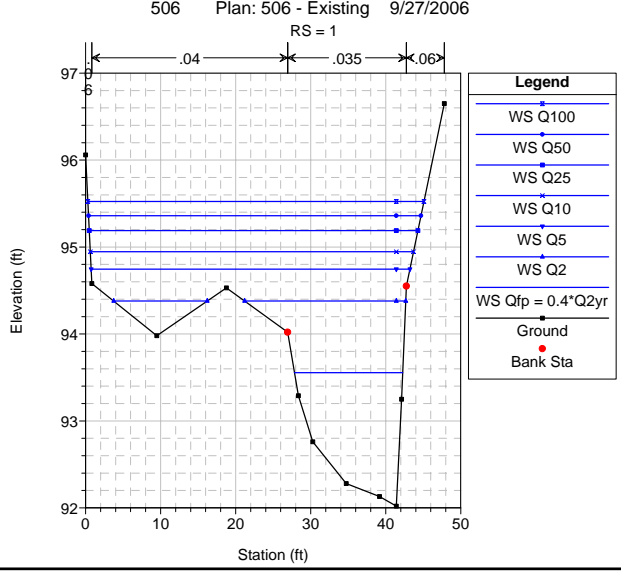
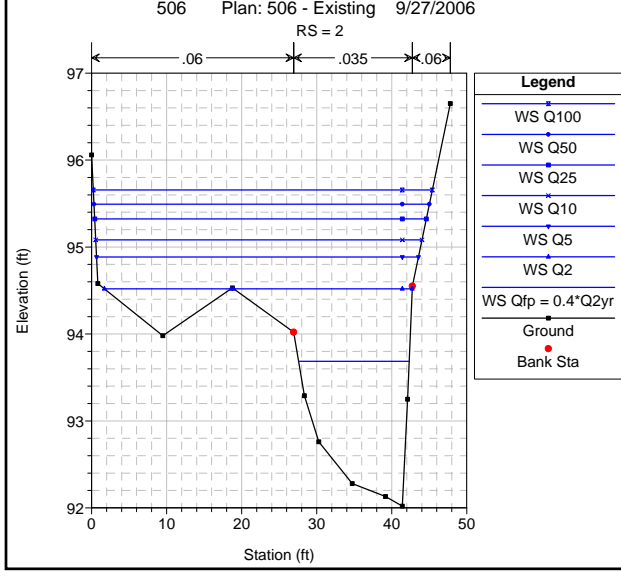
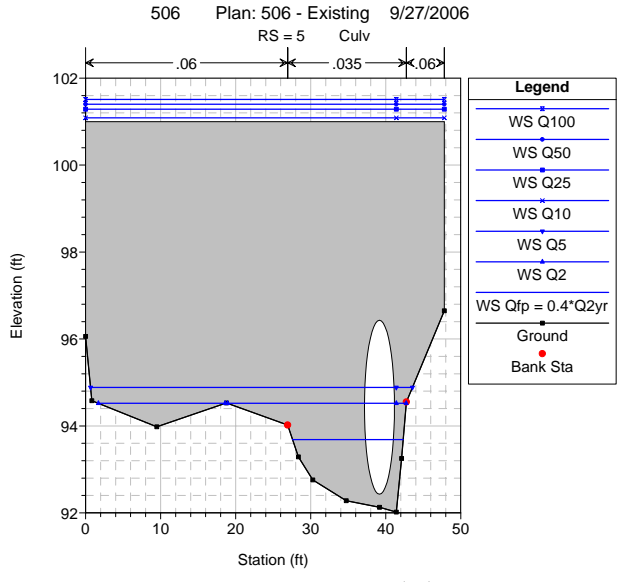
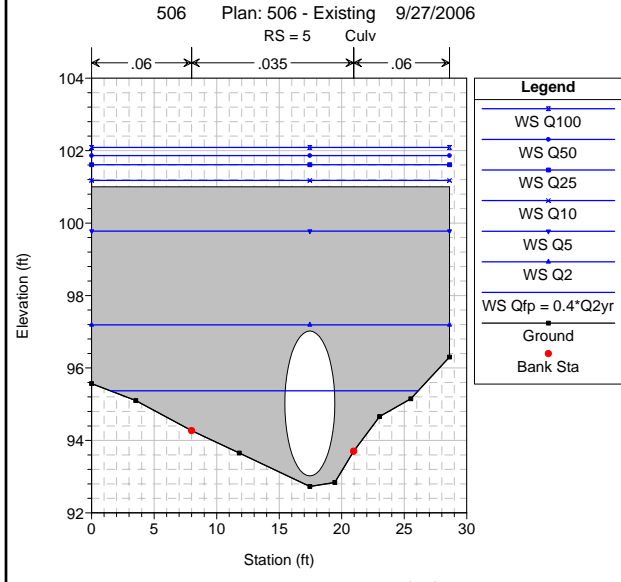
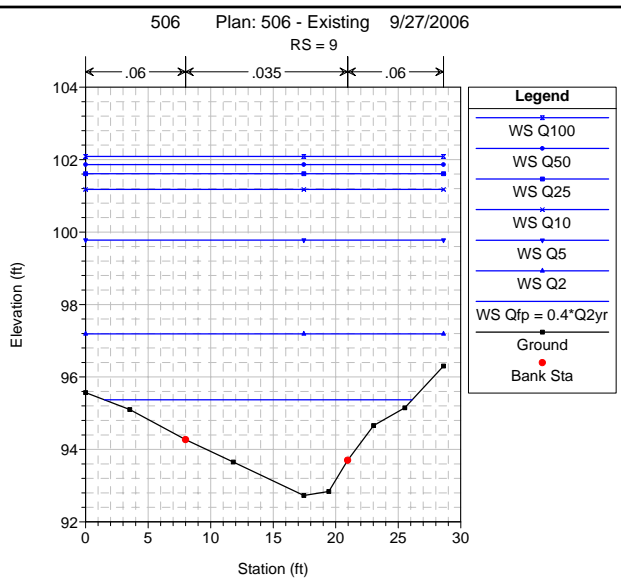
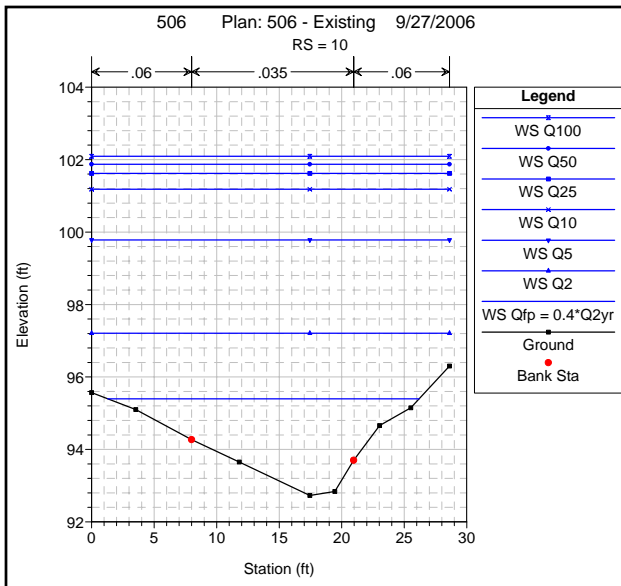

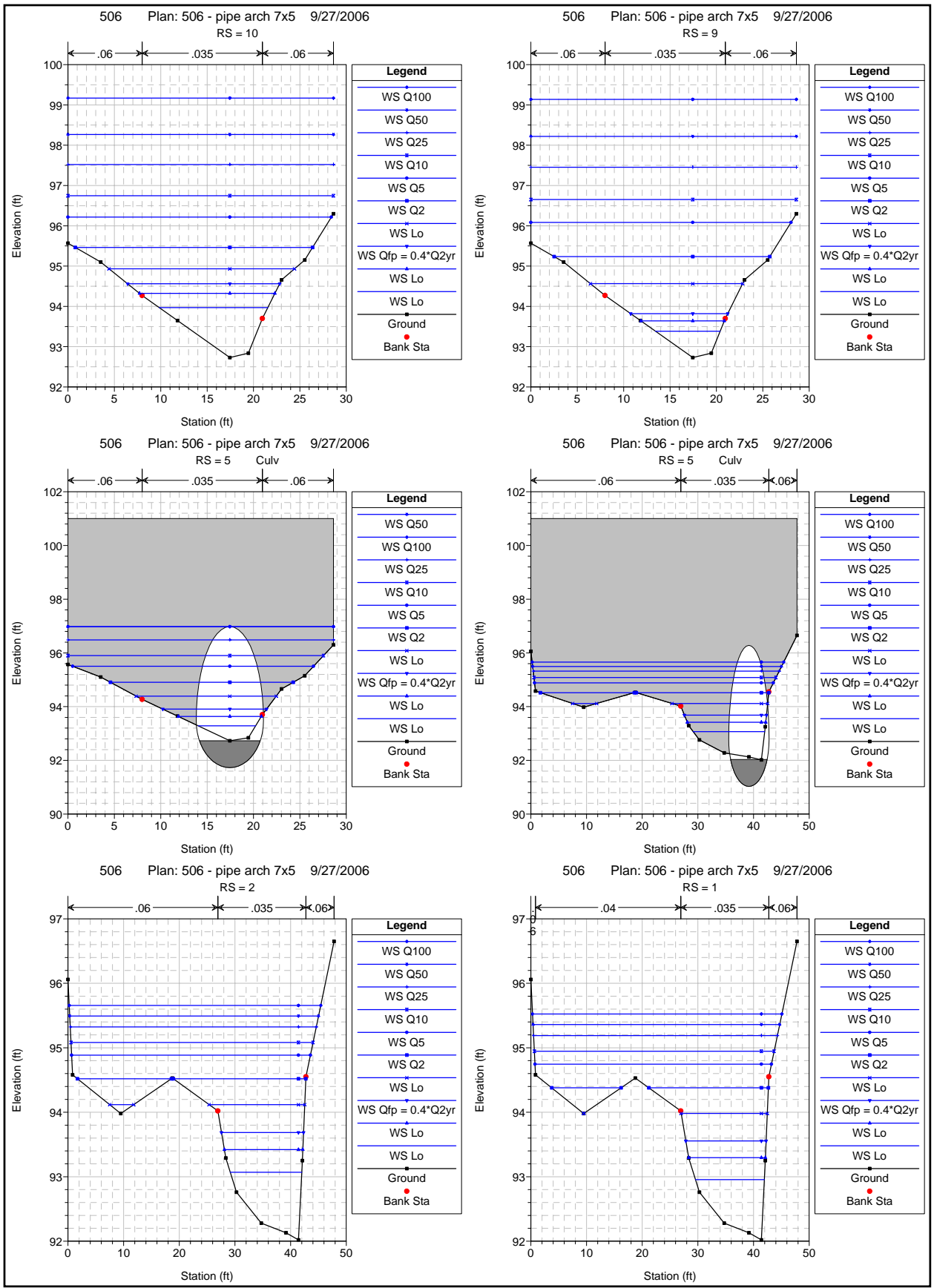

HEC-RAS River: 506 Trib Reach: 506

Reach	River Sta	Profile	Plan	Q Total (cfs)	Cum Ch Len (ft)	Min Ch El (ft)	W.S. Elev (ft)	Crit W.S. (ft)	E.G. Elev (ft)	E.G. Slope (ft/ft)	Max Chl Dpth (ft)	Hydr Depth C (ft)	Vel Chnl (ft/s)	Flow Area (sq ft)	Top Width (ft)	Top W Chnl (ft)	Froude # Chl	Shear Chan (lb/sq ft)
506	1	Lo	506-parch	10.00		92.02	92.95	92.56	92.98	0.002001	0.93	0.61	1.32	7.55	12.37	12.37	0.30	0.07
506	1	Lo	506-Ex	10.00		92.02	92.95	92.56	92.98	0.002001	0.93	0.61	1.32	7.55	12.37	12.37	0.30	0.07
506	1	Lo	506-parch	20.00		92.02	93.30	92.76	93.34	0.002001	1.28	0.87	1.66	12.01	13.79	13.79	0.31	0.10
506	1	Lo	506-Ex	20.00		92.02	93.30	92.76	93.34	0.002001	1.28	0.87	1.66	12.01	13.79	13.79	0.31	0.10
506	1	Qfp = 0.4*Q2yr	506-parch	30.00		92.02	93.56	92.91	93.61	0.002002	1.54	1.09	1.91	15.67	14.43	14.43	0.32	0.13
506	1	Qfp = 0.4*Q2yr	506-Ex	30.00		92.02	93.56	92.91	93.61	0.002002	1.54	1.09	1.91	15.67	14.43	14.43	0.32	0.13
506	1	Lo	506-parch	50.00		92.02	93.98	93.15	94.06	0.002001	1.96	1.43	2.27	22.06	15.54	15.47	0.33	0.16
506	1	Lo	506-Ex	50.00		92.02	93.98	93.15	94.06	0.002001	1.96	1.43	2.27	22.06	15.54	15.47	0.33	0.16
506	1	Q2	506-parch	76.00		92.02	94.38	93.41	94.48	0.002002	2.36	1.80	2.62	31.77	33.94	15.74	0.34	0.20
506	1	Q2	506-Ex	76.00		92.02	94.38	93.41	94.48	0.002002	2.36	1.80	2.62	31.77	33.94	15.74	0.34	0.20
506	1	Q5	506-parch	113.00		92.02	94.75	93.71	94.87	0.002004	2.73	2.15	2.95	46.54	42.47	15.82	0.35	0.24
506	1	Q5	506-Ex	113.00		92.02	94.75	93.71	94.87	0.002004	2.73	2.15	2.95	46.54	42.47	15.82	0.35	0.24
506	1	Q10	506-parch	139.00		92.02	94.95	93.89	95.08	0.002000	2.93	2.35	3.13	55.10	43.06	15.82	0.36	0.26
506	1	Q10	506-Ex	139.00		92.02	94.95	93.89	95.08	0.002000	2.93	2.35	3.13	55.10	43.06	15.82	0.36	0.26
506	1	Q25	506-parch	175.00		92.02	95.19	94.24	95.33	0.002001	3.17	2.60	3.34	65.65	43.79	15.82	0.37	0.29
506	1	Q25	506-Ex	175.00		92.02	95.19	94.24	95.33	0.002001	3.17	2.60	3.34	65.65	43.79	15.82	0.37	0.29
506	1	Q50	506-parch	203.00		92.02	95.36	94.56	95.51	0.002000	3.34	2.77	3.48	73.19	44.30	15.82	0.37	0.31
506	1	Q50	506-Ex	203.00		92.02	95.36	94.56	95.51	0.002000	3.34	2.77	3.48	73.19	44.30	15.82	0.37	0.31
506	1	Q100	506-parch	232.00		92.02	95.52	94.69	95.69	0.002002	3.50	2.93	3.62	80.51	44.79	15.82	0.37	0.33
506	1	Q100	506-Ex	232.00		92.02	95.52	94.69	95.69	0.002002	3.50	2.93	3.62	80.51	44.79	15.82	0.37	0.33
506	2	Lo	506-parch	10.00	70.00	92.02	93.07		93.09	0.001181	1.05	0.70	1.11	9.00	12.85	12.85	0.23	0.05
506	2	Lo	506-Ex	10.00	70.00	92.02	93.07		93.09	0.001181	1.05	0.70	1.11	9.00	12.85	12.85	0.23	0.05
506	2	Lo	506-parch	20.00	70.00	92.02	93.42		93.45	0.001326	1.40	0.97	1.46	13.74	14.10	14.10	0.26	0.08
506	2	Lo	506-Ex	20.00	70.00	92.02	93.42		93.45	0.001326	1.40	0.97	1.46	13.74	14.10	14.10	0.26	0.08
506	2	Qfp = 0.4*Q2yr	506-parch	30.00	70.00	92.02	93.69		93.73	0.001420	1.67	1.19	1.71	17.57	14.74	14.74	0.28	0.10
506	2	Qfp = 0.4*Q2yr	506-Ex	30.00	70.00	92.02	93.69		93.73	0.001420	1.67	1.19	1.71	17.57	14.74	14.74	0.28	0.10
506	2	Lo	506-parch	50.00	70.00	92.02	94.12		94.18	0.001499	2.10	1.55	2.07	24.54	21.48	15.61	0.29	0.13
506	2	Lo	506-Ex	50.00	70.00	92.02	94.12		94.18	0.001499	2.10	1.55	2.07	24.54	21.48	15.61	0.29	0.13
506	2	Q2	506-parch	76.00	70.00	92.02	94.52		94.61	0.001545	2.50	1.93	2.41	37.04	40.69	15.81	0.31	0.17
506	2	Q2	506-Ex	76.00	70.00	92.02	94.52		94.61	0.001545	2.50	1.93	2.41	37.04	40.69	15.81	0.31	0.17
506	2	Q5	506-parch	113.00	70.00	92.02	94.89		95.00	0.001653	2.87	2.29	2.79	52.52	42.89	15.82	0.33	0.21
506	2	Q5	506-Ex	113.00	70.00	92.02	94.89		95.00	0.001652	2.87	2.29	2.79	52.53	42.89	15.82	0.32	0.21
506	2	Q10	506-parch	139.00	70.00	92.02	95.08		95.21	0.001757	3.06	2.49	3.04	61.03	43.47	15.82	0.34	0.25
506	2	Q10	506-Ex	139.00	70.00	92.02	95.08		95.21	0.001758	3.06	2.49	3.04	61.03	43.47	15.82	0.34	0.25
506	2	Q25	506-parch	175.00	70.00	92.02	95.32		95.47	0.001880	3.30	2.73	3.35	71.53	44.19	15.82	0.36	0.29
506	2	Q25	506-Ex	175.00	70.00	92.02	95.32		95.47	0.001880	3.30	2.73	3.35	71.53	44.19	15.82	0.36	0.29
506	2	Q50	506-parch	203.00	70.00	92.02	95.49		95.65	0.001956	3.47	2.90	3.55	79.09	44.69	15.82	0.37	0.32
506	2	Q50	506-Ex	203.00	70.00	92.02	95.49		95.65	0.001956	3.47	2.90	3.55	79.09	44.69	15.82	0.37	0.32
506	2	Q100	506-parch	232.00	70.00	92.02	95.66		95.83	0.002026	3.64	3.06	3.75	86.41	45.18	15.82	0.38	0.35
506	2	Q100	506-Ex	232.00	70.00	92.02	95.66		95.83	0.002026	3.64	3.06	3.75	86.41	45.18	15.82	0.38	0.35
506	5			Culvert														
506	9	Lo	506-parch	10.00	135.00	92.73	93.38	93.38	93.59	0.025747	0.65	0.40	3.61	2.77	6.96	6.96	1.01	0.62
506	9	Lo	506-Ex	10.00	135.00	92.73	93.32	93.38	94.33	0.000394	1.59	0.95	0.80	12.78	14.55	12.96	0.14	0.02
506	9	Lo	506-parch	20.00	135.00	92.73	93.64	93.64	93.91	0.023084	0.91	0.53	4.16	4.81	8.98	8.98	1.00	0.75
506	9	Lo	506-Ex	20.00	135.00	92.73	94.89	93.64	94.91	0.000313	2.16	1.53	0.98	22.45	19.55	12.96	0.14	0.03
506	9	Qfp = 0.4*Q2yr	506-parch	30.00	135.00	92.73	93.82	93.82	94.15	0.021972	1.09	0.64	4.59	6.56	10.46	10.20	1.01	0.85
506	9	Qfp = 0.4*Q2yr	506-Ex	30.00	135.00	92.73	95.37	93.82	95.39	0.000264	2.64	2.01	1.08	32.99	24.60	12.96	0.13	0.03
506	9	Lo	506-parch	50.00	135.00	92.73	94.56	94.11	94.72	0.004505	1.83	1.20	3.16	16.59	16.41	12.96	0.51	0.33
506	9	Lo	506-Ex	50.00	135.00	92.73	96.21	94.11	96.22	0.000194	3.48	2.84	1.17	55.64	28.37	12.96	0.12	0.03
506	9	Q2	506-parch	76.00	135.00	92.73	95.24	94.38	95.36	0.002184	2.51	1.87	2.96	29.81	23.24	12.96	0.38	0.25
506	9	Q2	506-Ex	76.00	135.00	92.73	97.19	94.38	97.21	0.000144	4.46	3.83	1.23	83.83	28.62	12.96	0.11	0.03
506	9	Q5	506-parch	113.00	135.00	92.73	96.08	94.69	96.19	0.001172	3.35	2.72	2.78	52.22	28.04	12.96	0.30	0.19
506	9	Q5	506-Ex	113.00	135.00	92.73	99.78	94.69	99.79	0.000050	7.05	6.41	1.02	157.84	28.62	12.96	0.07	0.02
506	9	Q10	506-parch	139.00	135.00	92.73	96.65	94.90	96.75	0.000857	3.92	3.29	2.70	68.37	28.62	12.96	0.26	0.17
506	9	Q10	506-Ex	139.00	135.00	92.73	101.18	94.90	101.19	0.000039	8.45	7.81	1.02	197.92	28.62	12.96	0.06	0.02
506	9	Q25	506-parch	175.00	135.00	92.73	97.45	95.16	97.54	0.000598	4.72	4.09	2.61	91.34	28.62	12.96	0.23	0.15
506	9	Q25	506-Ex	175.00	135.00	92.73	101.61	95.16	101.63	0.000052	8.88	8.25	1.22	210.37	28.62	12.96	0.07	0.03
506	9	Q50	506-parch	203.00	135.00	92.73	98.22	95.35	98.29	0.000432	5.49	4.85	2.49	113.20	28.62	12.96	0.20	0.13
506	9	Q50	506-Ex	203.00	135.00	92.73	101.86	95.35	101.89	0.000063	9.13	8.50	1.38	217.57	28.62	12.96	0.08	0.03

HEC-RAS River: 506 Trib Reach: 506 (Continued)

Reach	River Sta	Profile	Plan	Q Total (cfs)	Cum Ch Len (ft)	Min Ch El (ft)	W.S. Elev (ft)	Crit W.S. (ft)	E.G. Elev (ft)	E.G. Slope (ft/ft)	Max Chl Dpth (ft)	Hydr Depth C (ft)	Vel Chnl (ft/s)	Flow Area (sq ft)	Top Width (ft)	Top W Chnl (ft)	Froude # Chl	Shear Chan (lb/sq ft)
506	9	Q100	506-parch	232.00	135.00	92.73	99.14	95.54	99.20	0.000306	6.41	5.77	2.35	139.49	28.62	12.96	0.17	0.11
506	9	Q100	506-Ex	232.00	135.00	92.73	102.09	95.54	102.11	0.000075	9.36	8.72	1.53	223.91	28.62	12.96	0.09	0.04
506	10	Lo	506-parch	10.00	245.00	92.73	93.97		93.99	0.001324	1.24	0.73	1.23	8.20	11.69	11.11	0.25	0.06
506	10	Lo	506-Ex	10.00	245.00	92.73	94.36		94.37	0.000342	1.63	0.99	0.77	13.38	14.86	12.96	0.14	0.02
506	10	Lo	506-parch	20.00	245.00	92.73	94.32		94.36	0.001550	1.59	0.96	1.60	12.85	14.58	12.96	0.29	0.09
506	10	Lo	506-Ex	20.00	245.00	92.73	94.93		94.94	0.000290	2.20	1.56	0.96	23.12	19.91	12.96	0.13	0.03
506	10	Qfp = 0.4*Q2yr	506-parch	30.00	245.00	92.73	94.56		94.62	0.001635	1.83	1.20	1.90	16.55	16.38	12.96	0.31	0.12
506	10	Qfp = 0.4*Q2yr	506-Ex	30.00	245.00	92.73	95.40		95.41	0.000251	2.67	2.03	1.06	33.71	24.89	12.96	0.13	0.03
506	10	Lo	506-parch	50.00	245.00	92.73	94.93		95.02	0.001775	2.20	1.57	2.37	23.29	20.00	12.96	0.33	0.17
506	10	Lo	506-Ex	50.00	245.00	92.73	96.23		96.25	0.000189	3.50	2.86	1.16	56.25	28.42	12.96	0.12	0.03
506	10	Q2	506-parch	76.00	245.00	92.73	95.46		95.56	0.001428	2.73	2.10	2.58	35.38	25.57	12.96	0.31	0.18
506	10	Q2	506-Ex	76.00	245.00	92.73	97.21		97.23	0.000142	4.48	3.84	1.22	84.28	28.62	12.96	0.11	0.03
506	10	Q5	506-parch	113.00	245.00	92.73	96.22		96.31	0.000978	3.49	2.85	2.62	55.94	28.39	12.96	0.27	0.17
506	10	Q5	506-Ex	113.00	245.00	92.73	99.78		99.80	0.000050	7.05	6.42	1.02	157.99	28.62	12.96	0.07	0.02
506	10	Q10	506-parch	139.00	245.00	92.73	96.75		96.84	0.000767	4.02	3.38	2.60	71.14	28.62	12.96	0.25	0.16
506	10	Q10	506-Ex	139.00	245.00	92.73	101.18		101.19	0.000039	8.45	7.82	1.02	198.04	28.62	12.96	0.06	0.02
506	10	Q25	506-parch	175.00	245.00	92.73	97.52		97.60	0.000563	4.79	4.16	2.56	93.28	28.62	12.96	0.22	0.14
506	10	Q25	506-Ex	175.00	245.00	92.73	101.62		101.64	0.000051	8.89	8.25	1.22	210.54	28.62	12.96	0.07	0.03
506	10	Q50	506-parch	203.00	245.00	92.73	98.27		98.34	0.000417	5.54	4.90	2.46	114.59	28.62	12.96	0.20	0.12
506	10	Q50	506-Ex	203.00	245.00	92.73	101.87		101.89	0.000063	9.14	8.51	1.37	217.77	28.62	12.96	0.08	0.03
506	10	Q100	506-parch	232.00	245.00	92.73	99.17		99.24	0.000300	6.44	5.81	2.33	140.47	28.62	12.96	0.17	0.11
506	10	Q100	506-Ex	232.00	245.00	92.73	102.09		102.12	0.000075	9.36	8.73	1.53	224.15	28.62	12.96	0.09	0.04

Tributary 512+24 HEC-RAS

Companion 2006 Stream and Habitat Inventory (S&HI) station 535+50
Model based on relative datum. Subtract 57.88-ft for approximate conversion to
ADOT&PF project datum

534 Plan: 10-Mile Existing 9/27/2006
RS = 10

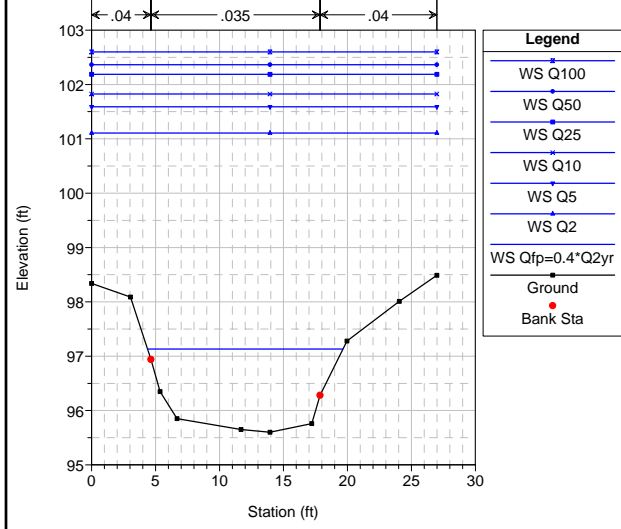

534 Plan: 10-Mile Existing 9/27/2006
RS = 9

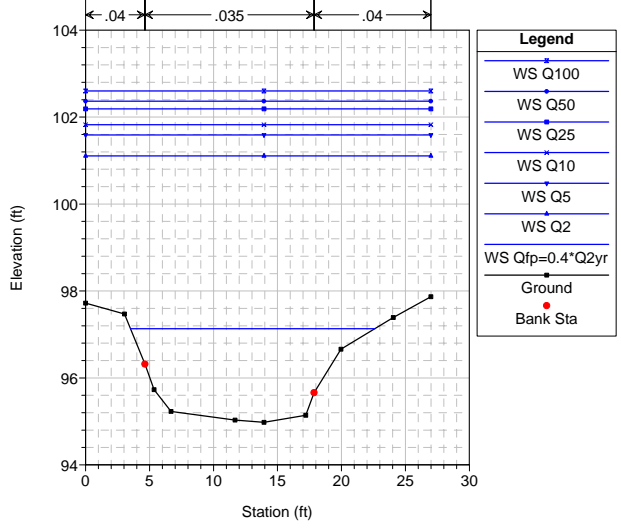

534 Plan: 10-Mile Existing 9/27/2006
RS = 5 Culv

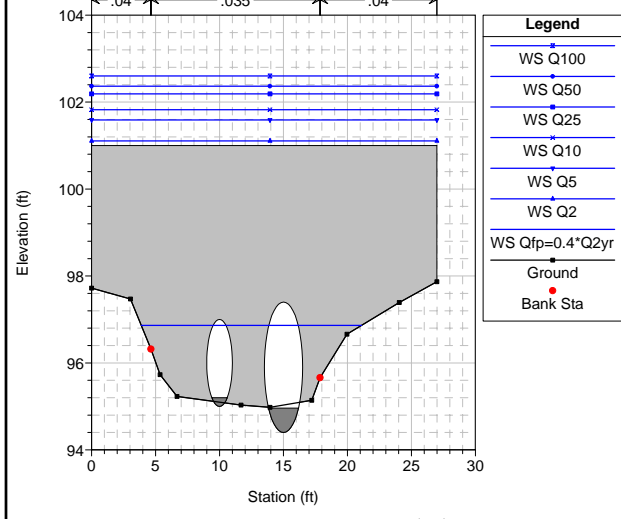

534 Plan: 10-Mile Existing 9/27/2006
RS = 5 Culv

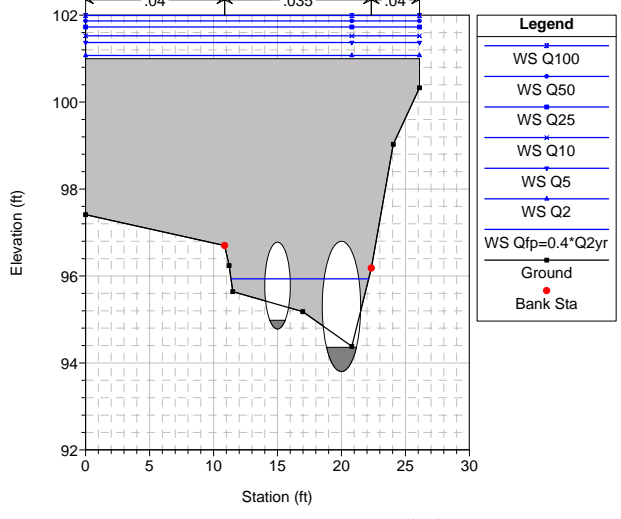

534 Plan: 10-Mile Existing 9/27/2006
RS = 2

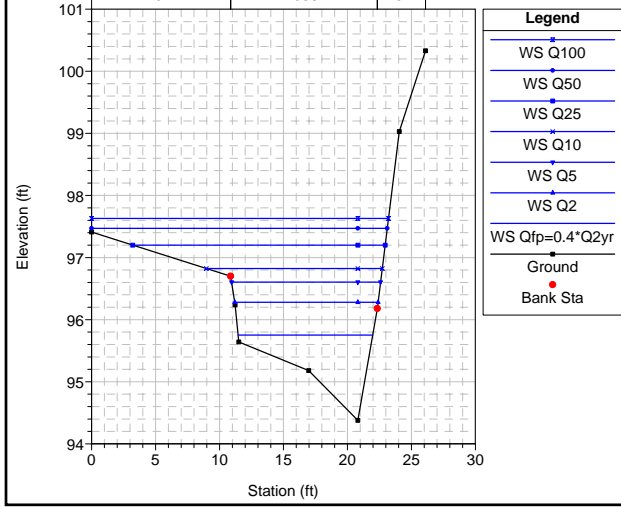

534 Plan: 10-Mile Existing 9/27/2006
RS = 1

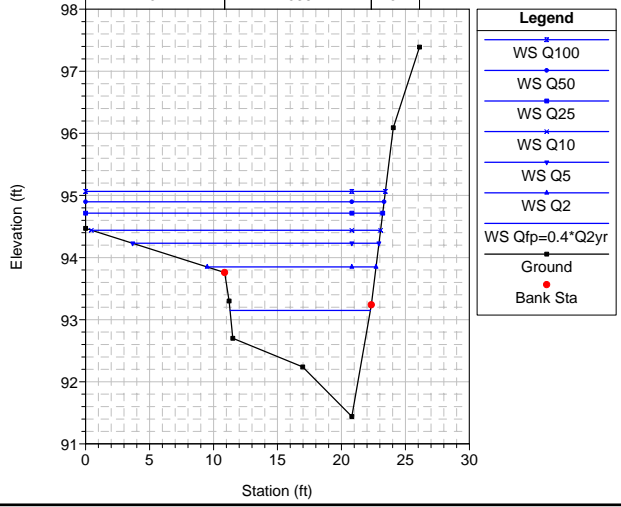

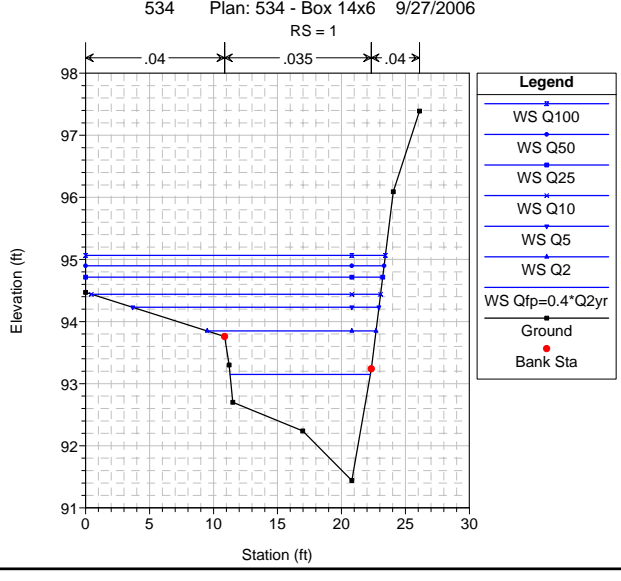
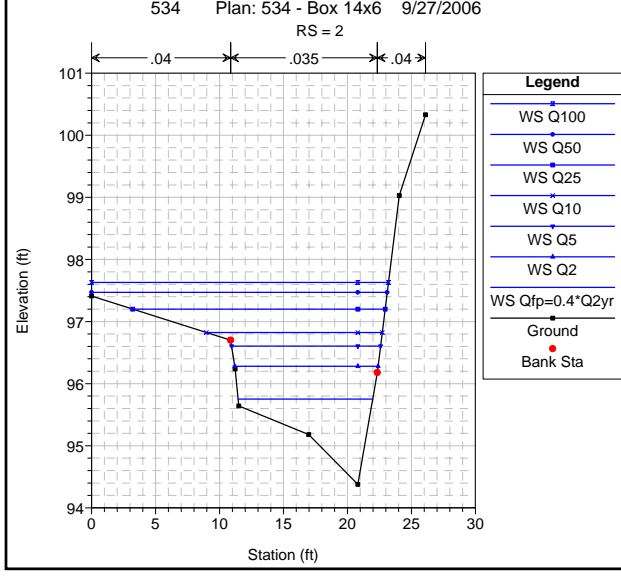
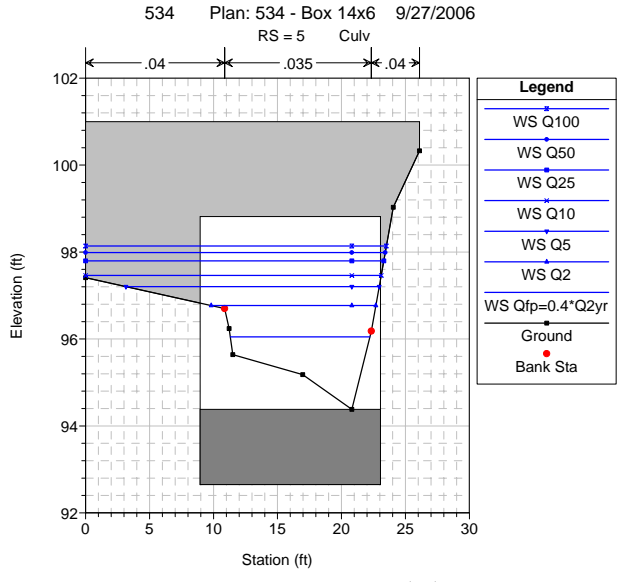
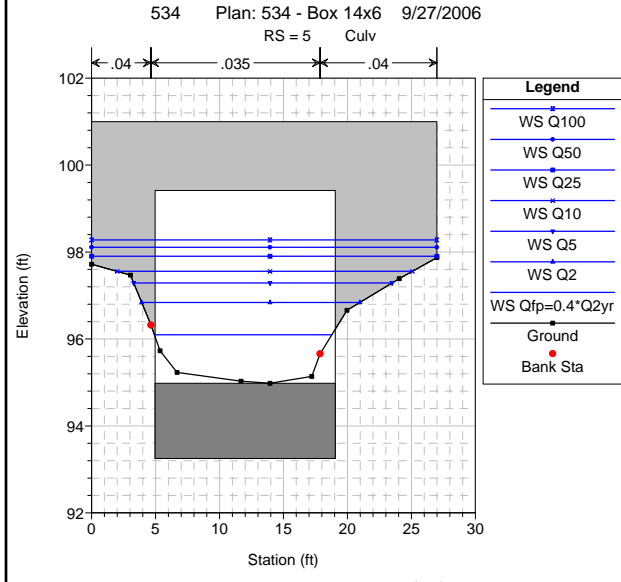
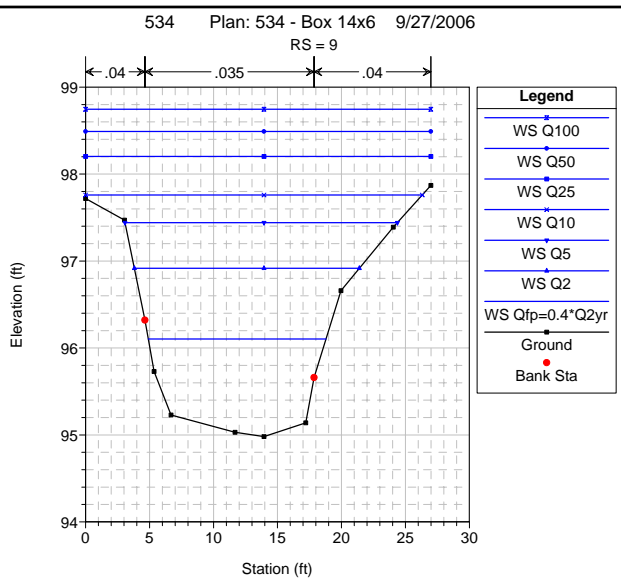
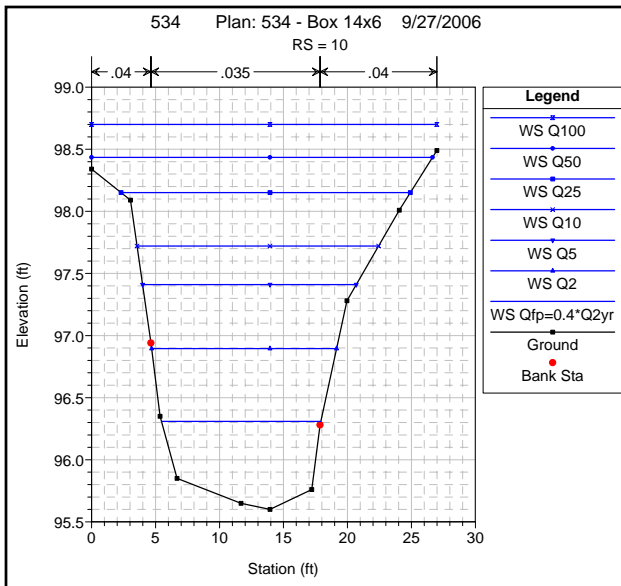

HEC-RAS River: 10-Mile Ck Reach: 534

Reach	River Sta	Profile	Plan	Q Total (cfs)	Cum Ch Len (ft)	Min Ch El (ft)	W.S. Elev (ft)	Crit W.S. (ft)	E.G. Elev (ft)	E.G. Slope (ft/ft)	Max Chl Dpth (ft)	Hydr Depth C (ft)	Vel Chnl (ft/s)	Flow Area (sq ft)	Top Width (ft)	Top W Chnl (ft)	Froude # Chl	Shear Chan (lb/sq ft)
534	1	Lo	534-box	10.00		91.44	92.68	92.40	92.74	0.006006	1.24	0.50	1.98	5.05	10.14	10.14	0.49	0.18
534	1	Lo	10Mi - Ex	10.00		91.44	92.68	92.40	92.74	0.006006	1.24	0.50	1.98	5.05	10.14	10.14	0.49	0.18
534	1	Lo	534-box	20.00		91.44	92.95	92.67	93.05	0.006000	1.51	0.74	2.53	7.89	10.70	10.70	0.52	0.25
534	1	Lo	10Mi - Ex	20.00		91.44	92.95	92.67	93.05	0.006000	1.51	0.74	2.53	7.89	10.70	10.70	0.52	0.25
534	1	Qfp=0.4*Q2yr	534-box	29.00		91.44	93.15	92.81	93.28	0.006006	1.71	0.91	2.89	10.02	10.96	10.96	0.53	0.31
534	1	Qfp=0.4*Q2yr	10Mi - Ex	29.00		91.44	93.15	92.81	93.28	0.006006	1.71	0.91	2.89	10.02	10.96	10.96	0.53	0.31
534	1	Lo	534-box	50.00		91.44	93.52	93.09	93.71	0.006006	2.08	1.25	3.53	14.17	11.45	11.28	0.56	0.42
534	1	Lo	10Mi - Ex	50.00		91.44	93.52	93.09	93.71	0.006006	2.08	1.25	3.53	14.17	11.45	11.28	0.56	0.42
534	1	Q2	534-box	73.00		91.44	93.85	93.34	94.11	0.006004	2.41	1.56	4.07	18.07	13.20	11.46	0.57	0.52
534	1	Q2	10Mi - Ex	73.00		91.44	93.85	93.34	94.11	0.006004	2.41	1.56	4.07	18.07	13.20	11.46	0.57	0.52
534	1	Q5	534-box	107.00		91.44	94.23	93.67	94.57	0.006002	2.79	1.94	4.71	24.25	19.26	11.46	0.60	0.64
534	1	Q5	10Mi - Ex	107.00		91.44	94.23	93.69	94.57	0.006002	2.79	1.94	4.71	24.25	19.26	11.46	0.60	0.64
534	1	Q10	534-box	130.00		91.44	94.44	93.89	94.82	0.006010	3.00	2.15	5.04	28.65	22.60	11.46	0.61	0.71
534	1	Q10	10Mi - Ex	130.00		91.44	94.44	93.89	94.82	0.006011	3.00	2.15	5.04	28.65	22.60	11.46	0.61	0.71
534	1	Q25	534-box	166.00		91.44	94.71	94.26	95.14	0.006002	3.27	2.43	5.46	34.99	23.22	11.46	0.62	0.80
534	1	Q25	10Mi - Ex	166.00		91.44	94.71	94.26	95.14	0.006002	3.27	2.43	5.46	34.99	23.22	11.46	0.62	0.80
534	1	Q50	534-box	193.00		91.44	94.90	94.53	95.36	0.006001	3.46	2.61	5.73	39.24	23.33	11.46	0.63	0.86
534	1	Q50	10Mi - Ex	193.00		91.44	94.90	94.53	95.36	0.006001	3.46	2.61	5.73	39.24	23.33	11.46	0.63	0.86
534	1	Q100	534-box	220.00		91.44	95.07	94.69	95.56	0.006009	3.63	2.78	5.98	43.20	23.43	11.46	0.63	0.92
534	1	Q100	10Mi - Ex	220.00		91.44	95.07	94.68	95.56	0.006009	3.63	2.78	5.98	43.20	23.43	11.46	0.63	0.92
534	2	Lo	534-box	10.00	186.00	94.38	95.34	95.34	95.55	0.027269	0.96	0.41	3.68	2.72	6.60	6.60	1.01	0.65
534	2	Lo	10Mi - Ex	10.00	186.00	94.38	95.34	95.34	95.55	0.027269	0.96	0.41	3.68	2.72	6.60	6.60	1.01	0.65
534	2	Lo	534-box	20.00	186.00	94.38	95.61	95.61	95.87	0.025530	1.23	0.49	4.06	4.93	9.99	9.99	1.02	0.74
534	2	Lo	10Mi - Ex	20.00	186.00	94.38	95.61	95.61	95.87	0.025530	1.23	0.49	4.06	4.93	9.99	9.99	1.02	0.74
534	2	Qfp=0.4*Q2yr	534-box	29.00	186.00	94.38	95.75	95.75	96.07	0.024355	1.37	0.61	4.53	6.40	10.51	10.51	1.02	0.86
534	2	Qfp=0.4*Q2yr	10Mi - Ex	29.00	186.00	94.38	95.75	95.75	96.07	0.024355	1.37	0.61	4.53	6.40	10.51	10.51	1.02	0.86
534	2	Lo	534-box	50.00	186.00	94.38	96.03	96.03	96.47	0.022092	1.65	0.86	5.35	9.35	10.88	10.88	1.02	1.08
534	2	Lo	10Mi - Ex	50.00	186.00	94.38	96.03	96.03	96.47	0.022092	1.65	0.86	5.35	9.35	10.88	10.88	1.02	1.08
534	2	Q2	534-box	73.00	186.00	94.38	96.28	96.28	96.84	0.020825	1.90	1.09	6.02	12.14	11.20	11.14	1.02	1.26
534	2	Q2	10Mi - Ex	73.00	186.00	94.38	96.28	96.28	96.84	0.020825	1.90	1.09	6.02	12.14	11.20	11.14	1.02	1.26
534	2	Q5	534-box	107.00	186.00	94.38	96.61	96.61	97.32	0.019382	2.23	1.39	6.77	15.85	11.64	11.39	1.01	1.48
534	2	Q5	10Mi - Ex	107.00	186.00	94.38	96.61	96.61	97.32	0.019382	2.23	1.39	6.77	15.85	11.64	11.39	1.01	1.48
534	2	Q10	534-box	130.00	186.00	94.38	96.82	96.82	97.60	0.017672	2.44	1.60	7.09	18.54	13.75	11.46	0.99	1.55
534	2	Q10	10Mi - Ex	130.00	186.00	94.38	96.82	96.82	97.60	0.017672	2.44	1.60	7.09	18.54	13.75	11.46	0.99	1.55
534	2	Q25	534-box	166.00	186.00	94.38	97.20	97.20	97.98	0.013654	2.82	1.97	7.17	24.83	19.73	11.46	0.90	1.48
534	2	Q25	10Mi - Ex	166.00	186.00	94.38	97.20	97.20	97.98	0.013654	2.82	1.97	7.17	24.83	19.73	11.46	0.90	1.48
534	2	Q50	534-box	193.00	186.00	94.38	97.47	97.47	98.21	0.011253	3.09	2.24	7.09	30.70	23.11	11.46	0.83	1.39
534	2	Q50	10Mi - Ex	193.00	186.00	94.38	97.47	97.47	98.21	0.011253	3.09	2.24	7.09	30.70	23.11	11.46	0.83	1.39
534	2	Q100	534-box	220.00	186.00	94.38	97.63	97.63	98.41	0.010979	3.25	2.40	7.34	34.44	23.21	11.46	0.83	1.45
534	2	Q100	10Mi - Ex	220.00	186.00	94.38	97.63	97.63	98.41	0.010979	3.25	2.40	7.34	34.44	23.21	11.46	0.83	1.45
534	5			Culvert														
534	9	Lo	534-box	10.00	261.00	94.98	95.56	95.38	95.62	0.005905	0.58	0.45	1.88	5.32	11.94	11.94	0.50	0.16
534	9	Lo	10Mi - Ex	10.00	261.00	94.98	95.56	95.38	95.62	0.005905	0.58	0.45	1.88	5.32	11.94	11.94	0.50	0.16
534	9	Lo	534-box	20.00	261.00	94.98	95.89	95.56	95.96	0.003914	1.11	0.93	2.83	12.21	13.86	12.95	0.15	0.02
534	9	Lo	10Mi - Ex	20.00	261.00	94.98	95.89	95.56	95.96	0.003914	1.11	0.93	2.83	12.21	13.86	12.95	0.15	0.02
534	9	Lo	534-box	20.00	261.00	94.98	96.66	95.56	96.68	0.003349	1.68	1.48	1.00	20.65	15.82	13.22	0.15	0.03
534	9	Lo	10Mi - Ex	20.00	261.00	94.98	96.66	95.56	96.68	0.003349	1.68	1.48	1.00	20.65	15.82	13.22	0.15	0.03
534	9	Qfp=0.4*Q2yr	534-box	29.00	261.00	94.98	96.10	95.69	96.19	0.003575	1.12	0.94	2.38	12.33	13.89	12.96	0.43	0.20
534	9	Qfp=0.4*Q2yr	10Mi - Ex	29.00	261.00	94.98	96.10	95.69	96.19	0.003575	1.12	0.94	2.38	12.33	13.89	12.96	0.43	0.20
534	9	Lo	534-box	50.00	261.00	94.98	96.53	95.93	96.64	0.003055	1.55	1.34	2.78	18.49	15.32	13.22	0.42	0.25
534	9	Lo	10Mi - Ex	50.00	261.00	94.98	96.53	95.93	96.64	0.003055	1.55	1.34	2.78	18.49	15.32	13.22	0.42	0.25
534	9	Q2	534-box	73.00	261.00	94.98	96.92	96.16	97.06	0.002693	1.94	1.73	3.10	24.87	17.59	13.22	0.42	0.28
534	9	Q2	10Mi - Ex	73.00	261.00	94.98	96.92	96.16	97.06	0.002693	1.94	1.73	3.10	24.87	17.59	13.22	0.42	0.28
534	9	Q5	534-box	107.00	261.00	94.98	97.44	96.46	97.61	0.002233	2.46	2.25	3.37	35.08	21.29	13.22	0.40	0.30
534	9	Q5	10Mi - Ex	107.00	261.00	94.98	97.44	96.46	97.61	0.002233	2.46	2.25	3.37	35.08	21.29	13.22	0.40	0.30
534	9	Q10	534-box	130.00	261.00	94.98	97.76	96.62	97.93	0.002023	2.78	2.57	3.50	42.64	26.31	13.22	0.38	0.31
534	9	Q10	10Mi - Ex	130.00	261.00	94.98	97.76	96.62	97.93	0.002023	2.78	2.57	3.50	42.64	26.31	13.22	0.38	0.31
534	9	Q25	534-box	166.00	261.00	94.98	98.20	96.89	98.38	0.001727	3.22	3.02	3.59	54.62	26.99	13.22	0.36	0.31
534	9	Q25	10Mi - Ex	166.00	261.00	94.98	98.20	96.89	98.38	0.001727	3.22	3.02	3.59	54.62	26.99	13.22	0.36	0.31
534	9	Q50	534-box	193.00	261.00	94.98	98.49	97.08	98.67	0.001620	3.51	3.00	3.70	62.33	26.99	13.22	0.36	0.32
534	9	Q50	10Mi - Ex	193.00	261.00	94.98	98.49	97.08	98.67	0.001620	3.51	3.00	3.70	62.33	26.99	13.22	0.36	0.32
534	9	Q100	534-box	220.00	261.00	94.98	98.75	97.26	98.94	0.001560	3.77	3.56	3.81	69.27	26.99	13.22	0.36	0.33
534	9	Q100	10Mi - Ex	220.00	261.00	94.98	98.75	97.26	98.94	0.001560	3.77	3.56	3.81	69.27	26.99	13.22	0.36	0.33
534	9	Q100	534-box	220.00	261.00	94.98	102.60	97.26	102.63	0.000105	7.62	7.41	1.61	173.27	26.99	13.22	0.10	0.05
534	9	Q100	10Mi - Ex	220.00	261.00	94.98	102.60	97.26	102.63	0.000105	7.62	7.41	1.61	173.27	26.99	13.22	0.10	0.05

HEC-RAS River: 10-Mile Ck Reach: 534 (Continued)

Reach	River Sta	Profile	Plan	Q Total (cfs)	Cum Ch Len (ft)	Min Ch El (ft)	W.S. Elev (ft)	Crit W.S. (ft)	E.G. Elev (ft)	E.G. Slope (ft/ft)	Max Chl Dpth (ft)	Hydr Depth C (ft)	Vel Chnl (ft/s)	Flow Area (sq ft)	Top Width (ft)	Top W Chnl (ft)	Froude # Chl	Shear Chan (lb/sq ft)
534	10	Lo	534-box	10.00	290.00	95.60	96.00	96.00	96.15	0.027776	0.40	0.29	3.07	3.25	11.24	11.24	1.01	0.50
534	10	Lo	10Mi - Ex	10.00	290.00	95.60	96.08		96.17	0.013703	0.48	0.35	2.46	4.07	11.52	11.52	0.73	0.30
534	10	Lo	534-box	20.00	290.00	95.60	96.18	96.18	96.40	0.024435	0.58	0.44	3.80	5.26	11.92	11.92	1.01	0.66
534	10	Lo	10Mi - Ex	20.00	290.00	95.60	96.66		96.71	0.002119	1.06	0.88	1.76	11.48	13.69	12.88	0.33	0.11
534	10	Q1p=0.4*Q2yr	534-box	29.00	290.00	95.60	96.31	96.31	96.59	0.022481	0.71	0.55	4.23	6.86	12.46	12.40	1.00	0.76
534	10	Q1p=0.4*Q2yr	10Mi - Ex	29.00	290.00	95.60	97.13		97.17	0.001066	1.53	1.32	1.63	18.28	15.27	13.22	0.25	0.08
534	10	Lo	534-box	50.00	290.00	95.60	96.55	96.55	96.94	0.020059	0.95	0.78	5.01	10.04	13.33	12.76	1.00	0.95
534	10	Lo	10Mi - Ex	50.00	290.00	95.60	98.65		98.67	0.000199	3.05	2.84	1.17	50.00	26.99	13.22	0.12	0.03
534	10	Q2	534-box	73.00	290.00	95.60	96.89	96.78	97.28	0.013095	1.29	1.09	5.03	14.77	14.46	13.17	0.85	0.86
534	10	Q2	10Mi - Ex	73.00	290.00	95.60	101.11		101.11	0.000038	5.51	5.30	0.77	116.20	26.99	13.22	0.06	0.01
534	10	Q5	534-box	107.00	290.00	95.60	97.41		97.78	0.007529	1.81	1.60	4.92	22.71	16.70	13.22	0.69	0.73
534	10	Q5	10Mi - Ex	107.00	290.00	95.60	101.59		101.60	0.000059	5.99	5.78	1.03	129.24	26.99	13.22	0.08	0.02
534	10	Q10	534-box	130.00	290.00	95.60	97.72		98.09	0.005972	2.12	1.91	4.93	28.23	18.88	13.22	0.63	0.69
534	10	Q10	10Mi - Ex	130.00	290.00	95.60	101.83		101.84	0.000076	6.23	6.02	1.19	135.62	26.99	13.22	0.09	0.03
534	10	Q25	534-box	166.00	290.00	95.60	98.15		98.52	0.004674	2.55	2.34	5.00	37.02	22.61	13.22	0.58	0.66
534	10	Q25	10Mi - Ex	166.00	290.00	95.60	102.19		102.21	0.000100	6.59	6.38	1.43	145.40	26.99	13.22	0.10	0.04
534	10	Q50	534-box	193.00	290.00	95.60	98.43		98.80	0.004099	2.83	2.63	5.05	44.12	26.65	13.22	0.55	0.65
534	10	Q50	10Mi - Ex	193.00	290.00	95.60	102.36		102.40	0.000123	6.76	6.56	1.61	150.19	26.99	13.22	0.11	0.05
534	10	Q100	534-box	220.00	290.00	95.60	98.70		99.06	0.003601	3.10	2.89	5.05	51.27	26.99	13.22	0.52	0.63
534	10	Q100	10Mi - Ex	220.00	290.00	95.60	102.60		102.64	0.000142	7.00	6.79	1.77	156.50	26.99	13.22	0.12	0.06

Tributary 589+12 HEC-RAS

Companion 2006 Stream and Habitat Inventory (S&HI) station 612+40
Model based on ADOT&PF project datum

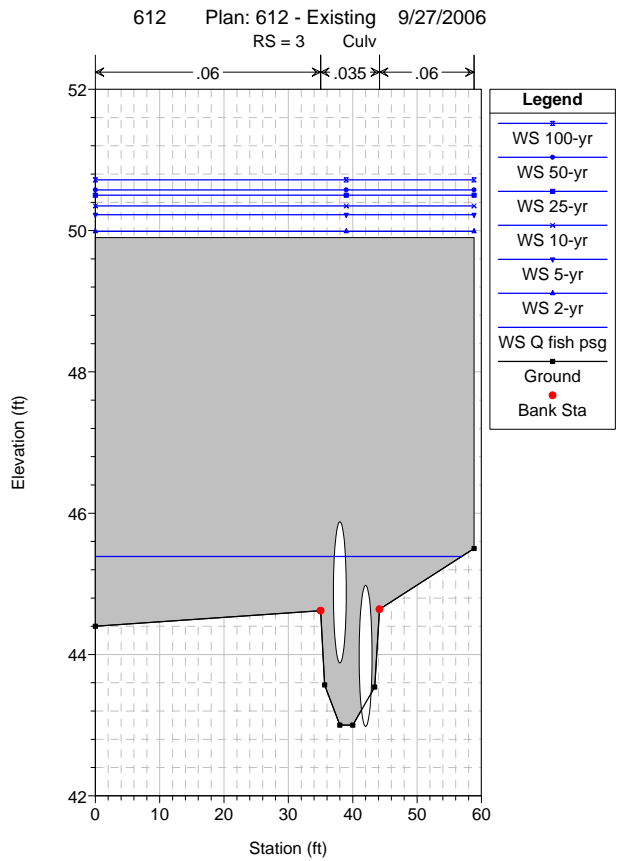
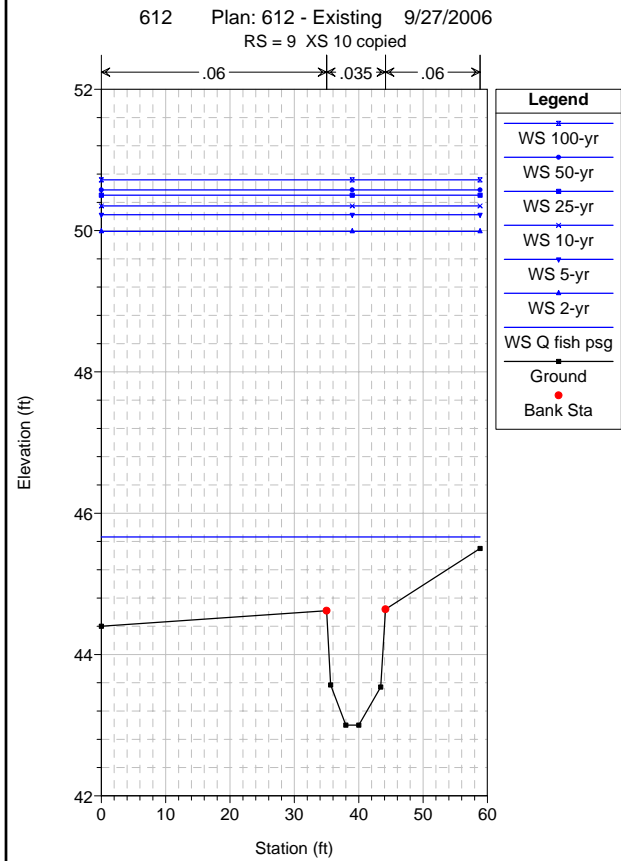
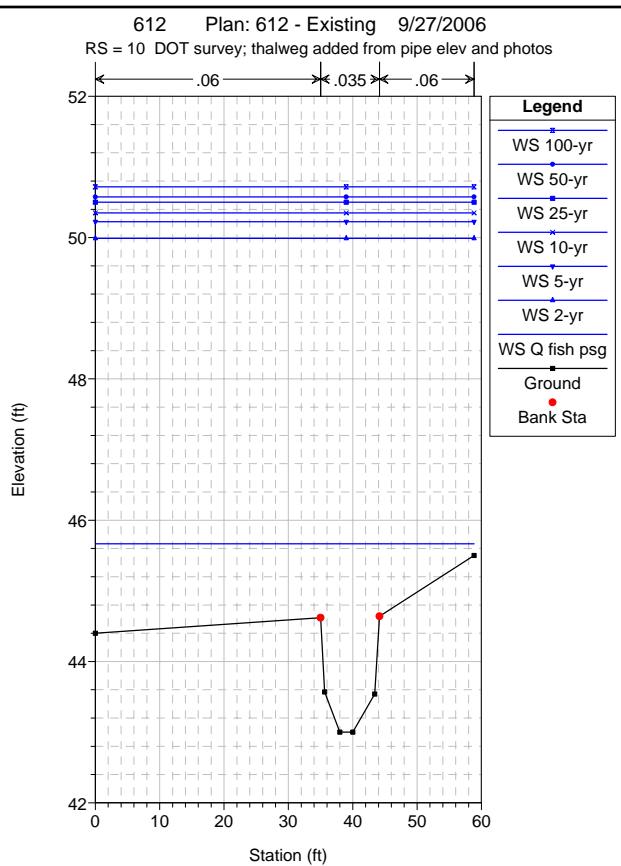
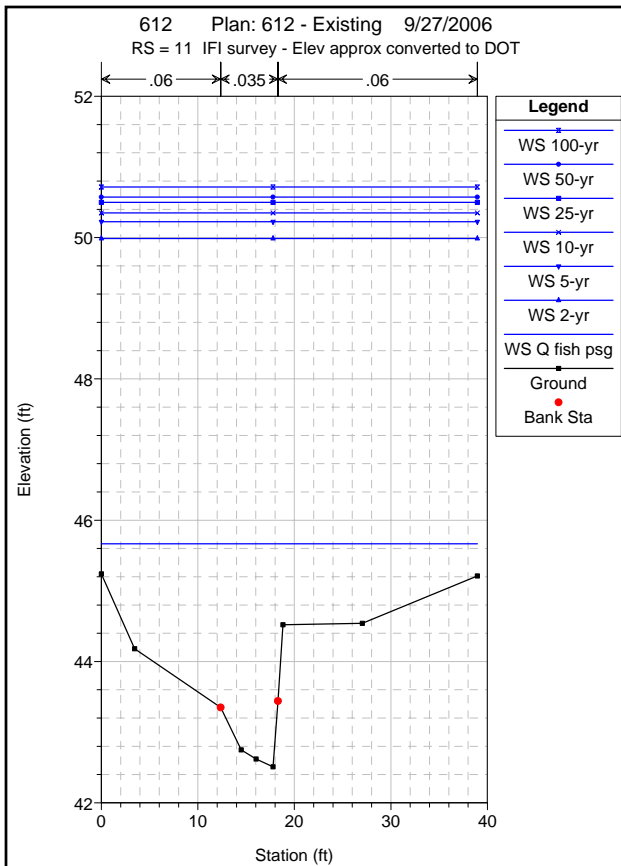

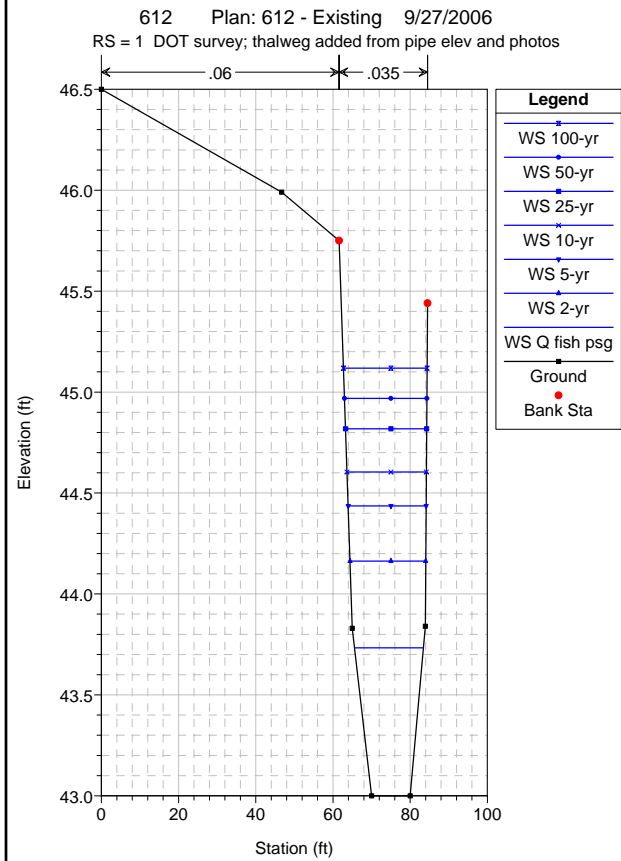
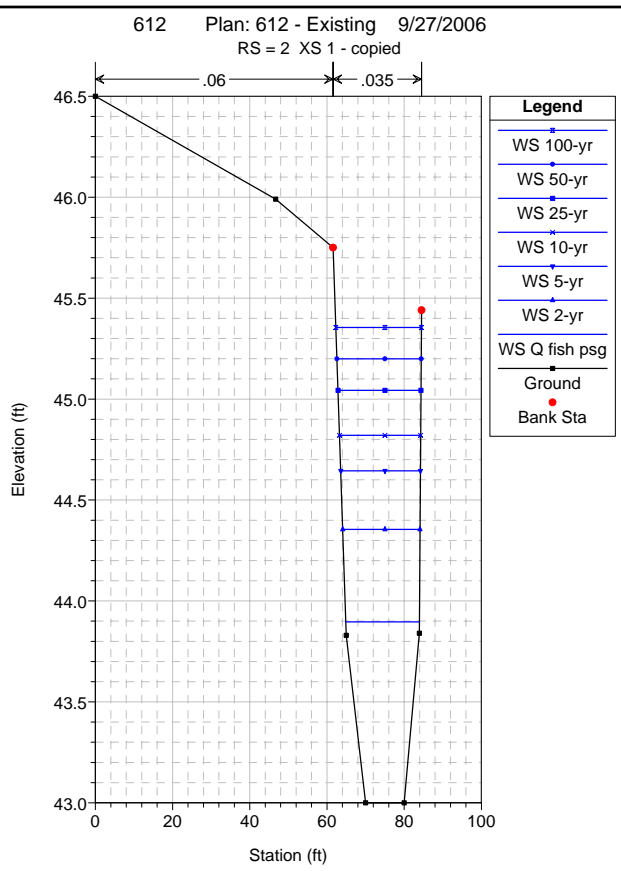
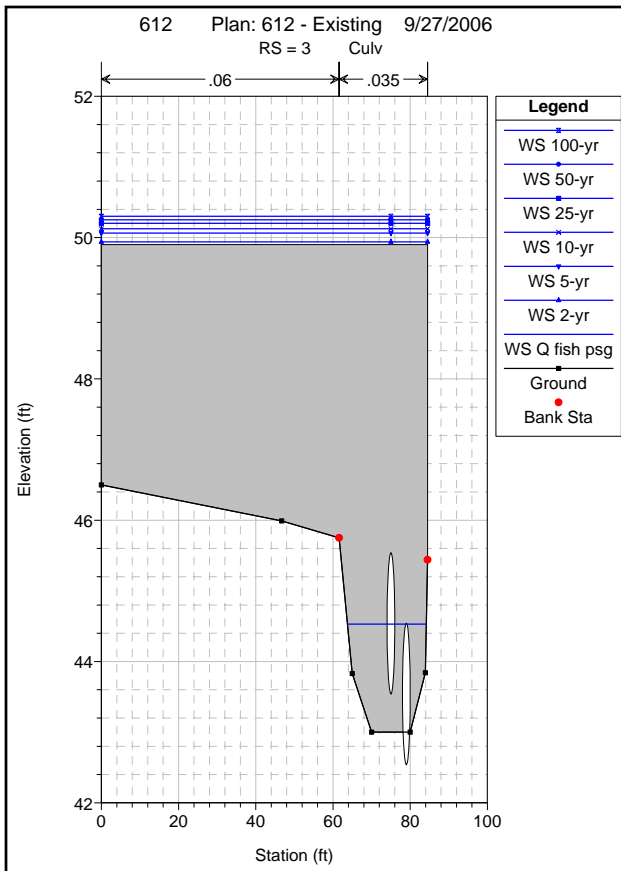

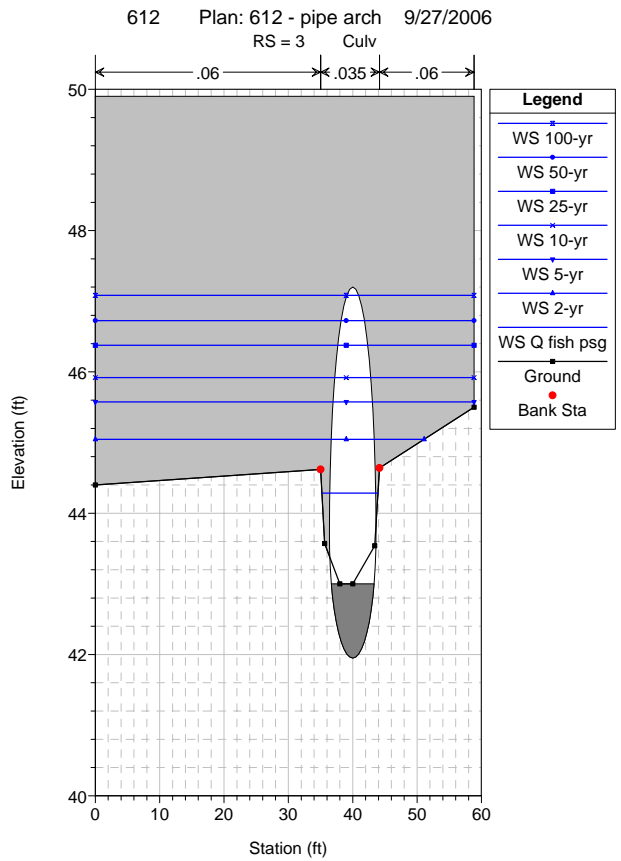
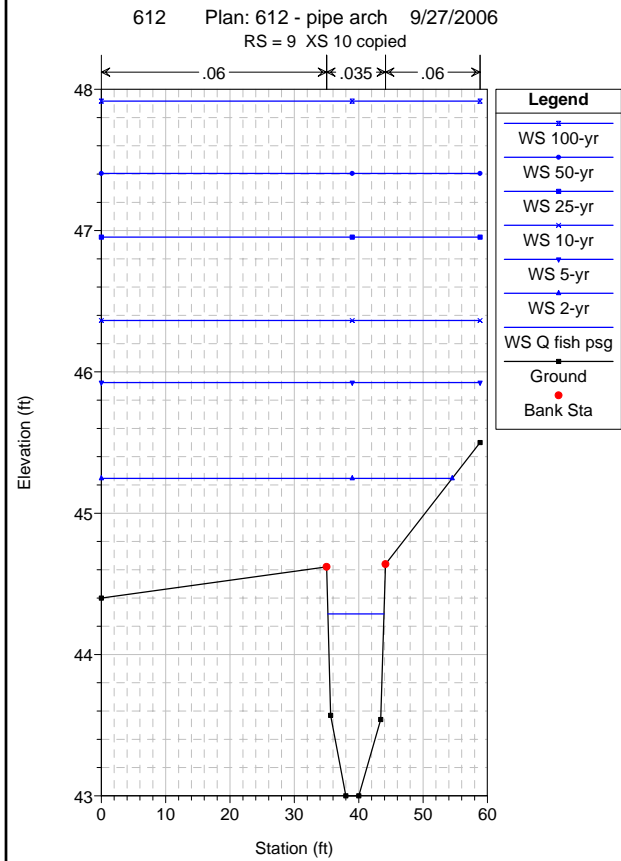
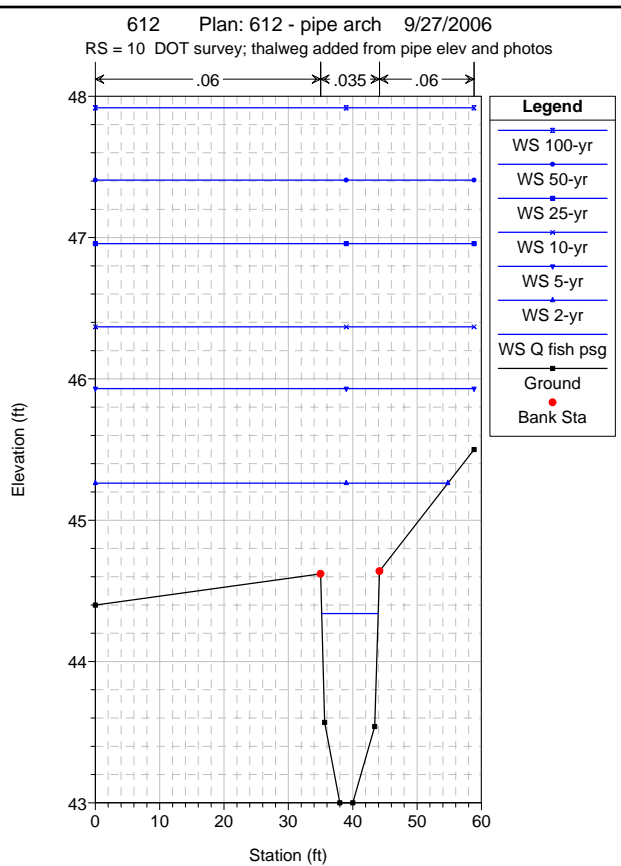
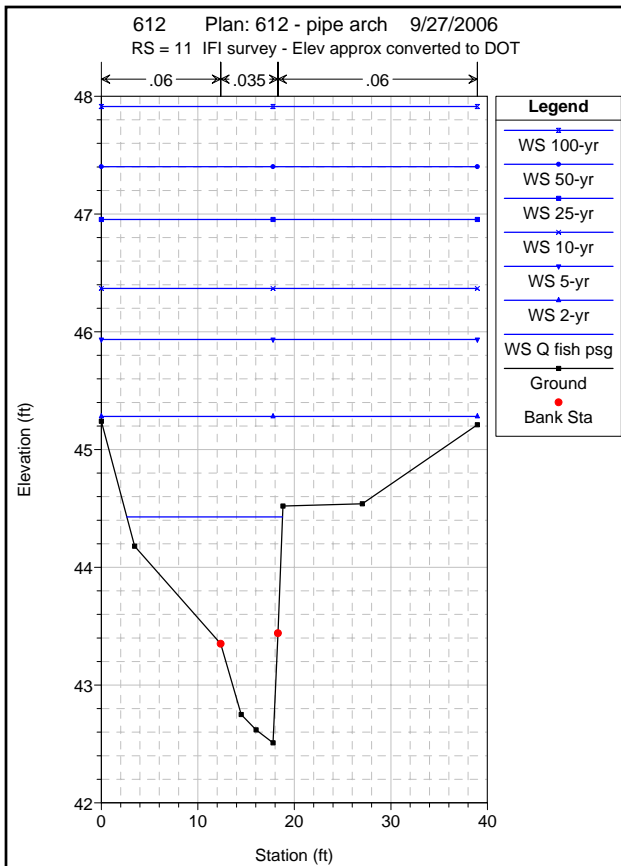

612 Plan: 612 - pipe arch 9/27/2006
RS = 3 Culv

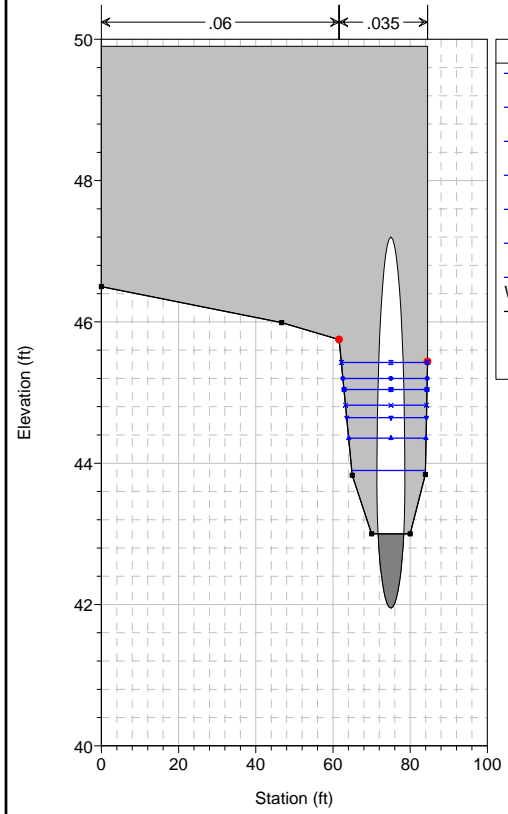

- Legend**
- WS 100-yr
 - WS 50-yr
 - WS 25-yr
 - WS 10-yr
 - WS 5-yr
 - WS 2-yr
 - WS Q fish psg
 - Ground
 - Bank Sta

612 Plan: 612 - pipe arch 9/27/2006
RS = 2 XS 1 - copied

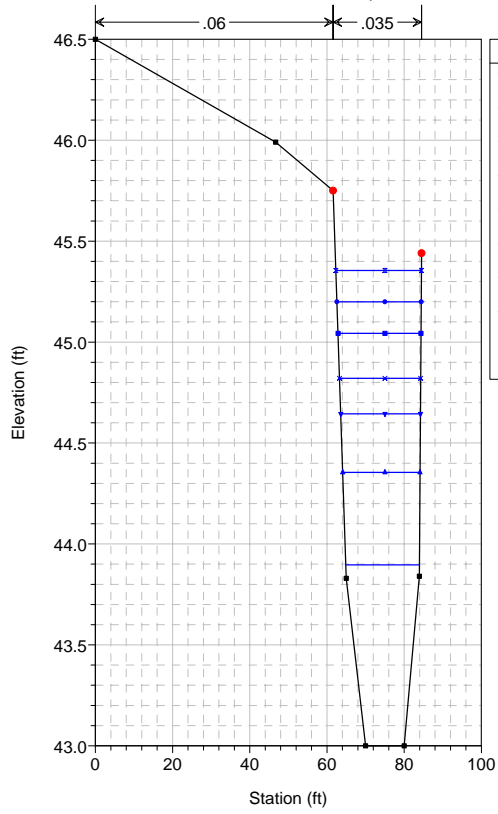

- Legend**
- WS 100-yr
 - WS 50-yr
 - WS 25-yr
 - WS 10-yr
 - WS 5-yr
 - WS 2-yr
 - WS Q fish psg
 - Ground
 - Bank Sta

612 Plan: 612 - pipe arch 9/27/2006
RS = 1 DOT survey; thalweg added from pipe elev and photos

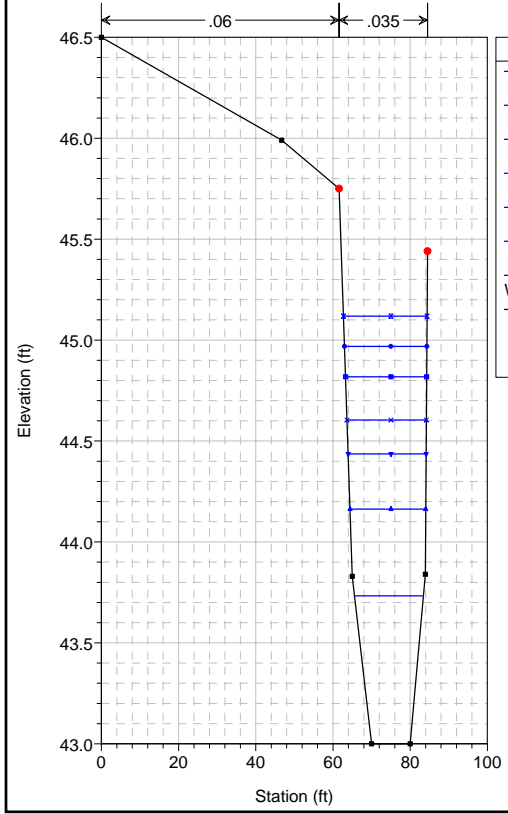

- Legend**
- WS 100-yr
 - WS 50-yr
 - WS 25-yr
 - WS 10-yr
 - WS 5-yr
 - WS 2-yr
 - WS Q fish psg
 - Ground
 - Bank Sta

HEC-RAS River: 612 Reach: 612

Reach	River Sta	Profile	Plan	Q Total (cfs)	Cum Ch Len (ft)	Min Ch El (ft)	W.S. Elev (ft)	Crit W.S. (ft)	E.G. Elev (ft)	E.G. Slope (ft/ft)	Max Chl Dpth (ft)	Hydr Depth C (ft)	Vel Chnl (ft/s)	Flow Area (sq ft)	Top Width (ft)	Top W Chnl (ft)	Froude # Chl	Shear Chan (lb/sq ft)
612	1	Lo	612 - Parch	2.00		43.00	43.19	43.11	43.21	0.005000	0.19	0.18	0.94	2.12	12.05	12.05	0.40	0.05
612	1	Lo	612-Ex	2.00		43.00	43.19	43.11	43.21	0.005000	0.19	0.18	0.94	2.12	12.05	12.05	0.40	0.05
612	1	Lo	612 - Parch	10.00		43.00	43.49	43.30	43.53	0.005001	0.49	0.40	1.63	6.13	15.19	15.19	0.45	0.13
612	1	Lo	612-Ex	10.00		43.00	43.49	43.30	43.53	0.005001	0.49	0.40	1.63	6.13	15.19	15.19	0.45	0.13
612	1	Q fish psg	612 - Parch	21.00		43.00	43.73	43.47	43.80	0.005004	0.73	0.57	2.06	10.20	17.82	17.82	0.48	0.18
612	1	Q fish psg	612-Ex	21.00		43.00	43.73	43.47	43.80	0.005004	0.73	0.57	2.06	10.20	17.82	17.82	0.48	0.18
612	1	Lo	612 - Parch	35.00		43.00	43.95	43.64	44.05	0.005004	0.95	0.75	2.45	14.30	19.16	19.16	0.50	0.23
612	1	Lo	612-Ex	35.00		43.00	43.95	43.64	44.05	0.005004	0.95	0.75	2.45	14.30	19.16	19.16	0.50	0.23
612	1	2-yr	612 - Parch	52.00		43.00	44.16	43.81	44.29	0.005003	1.16	0.94	2.83	18.37	19.61	19.61	0.52	0.29
612	1	2-yr	612-Ex	52.00		43.00	44.16	43.81	44.29	0.005003	1.16	0.94	2.83	18.37	19.61	19.61	0.52	0.29
612	1	5-yr	612 - Parch	78.00		43.00	44.44	44.00	44.60	0.005001	1.44	1.18	3.27	23.83	20.20	20.20	0.53	0.36
612	1	5-yr	612-Ex	78.00		43.00	44.44	44.01	44.60	0.005001	1.44	1.18	3.27	23.83	20.20	20.20	0.53	0.36
612	1	10-yr	612 - Parch	96.00		43.00	44.60	44.13	44.80	0.005004	1.60	1.33	3.52	27.25	20.56	20.56	0.54	0.40
612	1	10-yr	612-Ex	96.00		43.00	44.60	44.13	44.80	0.005004	1.60	1.33	3.52	27.25	20.56	20.56	0.54	0.40
612	1	25-yr	612 - Parch	121.00		43.00	44.82	44.28	45.04	0.005000	1.82	1.51	3.82	31.70	21.02	21.02	0.55	0.45
612	1	25-yr	612-Ex	121.00		43.00	44.82	44.29	45.04	0.005000	1.82	1.51	3.82	31.70	21.02	21.02	0.55	0.45
612	1	50-yr	612 - Parch	140.00		43.00	44.97	44.39	45.22	0.005003	1.97	1.63	4.01	34.88	21.34	21.34	0.55	0.48
612	1	50-yr	612-Ex	140.00		43.00	44.97	44.39	45.22	0.005003	1.97	1.63	4.01	34.88	21.34	21.34	0.55	0.48
612	1	100-yr	612 - Parch	160.00		43.00	45.12	44.50	45.39	0.005001	2.12	1.76	4.20	38.11	21.66	21.66	0.56	0.52
612	1	100-yr	612-Ex	160.00		43.00	45.12	44.50	45.39	0.005001	2.12	1.76	4.20	38.11	21.66	21.66	0.56	0.52
612	2	Lo	612 - Parch	2.00	41.00	43.00	43.29		43.30	0.001217	0.29	0.26	0.60	3.36	13.10	13.10	0.21	0.02
612	2	Lo	612-Ex	2.00	41.00	43.00	43.29		43.30	0.001217	0.29	0.26	0.60	3.36	13.10	13.10	0.21	0.02
612	2	Lo	612 - Parch	10.00	41.00	43.00	43.63		43.65	0.001969	0.63	0.50	1.19	8.42	16.72	16.72	0.29	0.06
612	2	Lo	612-Ex	10.00	41.00	43.00	43.63		43.65	0.001974	0.63	0.50	1.19	8.42	16.72	16.72	0.30	0.06
612	2	Q fish psg	612 - Parch	21.00	41.00	43.00	43.90		43.94	0.002301	0.90	0.70	1.59	13.24	19.04	19.04	0.34	0.10
612	2	Q fish psg	612-Ex	21.00	41.00	43.00	43.90		43.94	0.002301	0.90	0.70	1.59	13.24	19.04	19.04	0.34	0.10
612	2	Lo	612 - Parch	35.00	41.00	43.00	44.13		44.19	0.002533	1.13	0.91	1.97	17.73	19.54	19.54	0.37	0.14
612	2	Lo	612-Ex	35.00	41.00	43.00	44.13		44.19	0.002532	1.13	0.91	1.97	17.74	19.54	19.54	0.37	0.14
612	2	2-yr	612 - Parch	52.00	41.00	43.00	44.35		44.44	0.002774	1.35	1.11	2.34	22.19	20.02	20.02	0.39	0.19
612	2	2-yr	612-Ex	52.00	41.00	43.00	44.35		44.44	0.002774	1.35	1.11	2.34	22.19	20.02	20.02	0.39	0.19
612	2	5-yr	612 - Parch	78.00	41.00	43.00	44.64		44.76	0.003015	1.64	1.36	2.78	28.07	20.64	20.64	0.42	0.24
612	2	5-yr	612-Ex	78.00	41.00	43.00	44.64		44.76	0.003015	1.64	1.36	2.78	28.07	20.64	20.64	0.42	0.24
612	2	10-yr	612 - Parch	96.00	41.00	43.00	44.82		44.96	0.003136	1.82	1.51	3.02	31.74	21.02	21.02	0.43	0.28
612	2	10-yr	612-Ex	96.00	41.00	43.00	44.82		44.96	0.003136	1.82	1.51	3.02	31.74	21.02	21.02	0.43	0.28
612	2	25-yr	612 - Parch	121.00	41.00	43.00	45.04		45.21	0.003264	2.04	1.70	3.32	36.48	21.50	21.50	0.45	0.33
612	2	25-yr	612-Ex	121.00	41.00	43.00	45.04		45.21	0.003263	2.04	1.70	3.32	36.48	21.50	21.50	0.45	0.33
612	2	50-yr	612 - Parch	140.00	41.00	43.00	45.20		45.39	0.003343	2.20	1.83	3.51	39.86	21.83	21.83	0.46	0.36
612	2	50-yr	612-Ex	140.00	41.00	43.00	45.20		45.39	0.003343	2.20	1.83	3.51	39.86	21.83	21.83	0.46	0.36
612	2	100-yr	612 - Parch	160.00	41.00	43.00	45.35		45.57	0.003413	2.35	1.95	3.70	43.27	22.17	22.17	0.47	0.39
612	2	100-yr	612-Ex	160.00	41.00	43.00	45.35		45.57	0.003413	2.35	1.95	3.70	43.27	22.17	22.17	0.47	0.39
612	3			Culvert														
612	9	Lo	612 - Parch	2.00	105.00	43.00	43.38	43.25	43.41	0.006033	0.38	0.25	1.31	1.52	6.00	6.00	0.46	0.09
612	9	Lo	612-Ex	2.00	105.00	43.00	43.80	43.25	43.81	0.000220	0.80	0.58	0.42	4.71	8.12	8.12	0.10	0.01
612	9	Lo	612 - Parch	10.00	105.00	43.00	43.87	43.57	43.93	0.003931	0.87	0.64	1.91	5.25	8.20	8.20	0.42	0.15
612	9	Lo	612-Ex	10.00	105.00	43.00	44.74	43.57	44.75	0.000204	1.74	1.40	0.70	20.97	45.86	9.16	0.10	0.02
612	9	Q fish psg	612 - Parch	21.00	105.00	43.00	44.29	43.81	44.38	0.003597	1.29	1.01	2.39	8.78	8.73	8.73	0.42	0.20
612	9	Q fish psg	612-Ex	21.00	105.00	43.00	45.66	43.81	45.67	0.000061	2.66	2.33	0.53	70.46	58.86	9.16	0.06	0.01
612	9	Lo	612 - Parch	35.00	105.00	43.00	44.73	44.06	44.81	0.002598	1.73	1.39	2.47	20.48	45.68	9.16	0.37	0.20
612	9	Lo	612-Ex	35.00	105.00	43.00	47.45	44.06	47.45	0.000012	4.45	4.11	0.35	175.33	58.86	9.16	0.03	0.00
612	9	2-yr	612 - Parch	52.00	105.00	43.00	45.25	44.30	45.29	0.001064	2.25	1.91	1.95	46.41	54.53	9.16	0.25	0.11
612	9	2-yr	612-Ex	52.00	105.00	43.00	49.99	44.30	49.99	0.000004	6.99	6.65	0.27	324.96	58.86	9.16	0.02	0.00
612	9	5-yr	612 - Parch	78.00	105.00	43.00	45.92	44.82	45.95	0.000493	2.92	2.59	1.63	85.80	58.86	9.16	0.18	0.07
612	9	5-yr	612-Ex	78.00	105.00	43.00	50.22	44.82	50.23	0.000008	7.22	6.89	0.39	338.89	58.86	9.16	0.03	0.00
612	9	10-yr	612 - Parch	96.00	105.00	43.00	46.36	44.92	46.38	0.000350	3.36	3.03	1.52	111.66	58.86	9.16	0.15	0.06
612	9	10-yr	612-Ex	96.00	105.00	43.00	50.35	44.92	50.35	0.000011	7.35	7.01	0.48	346.21	58.86	9.16	0.03	0.00
612	9	25-yr	612 - Parch	121.00	105.00	43.00	46.95	45.07	46.97	0.000248	3.95	3.62	1.44	146.38	58.86	9.16	0.13	0.05
612	9	25-yr	612-Ex	121.00	105.00	43.00	50.50	45.07	50.50	0.000016	7.50	7.16	0.58	355.15	58.86	9.16	0.04	0.01
612	9	50-yr	612 - Parch	140.00	105.00	43.00	47.40	45.13	47.42	0.000200	4.40	4.07	1.40	172.89	58.86	9.16	0.12	0.04
612	9	50-yr	612-Ex	140.00	105.00	43.00	50.58	45.15	50.58	0.000021	7.58	7.24	0.67	359.52	58.86	9.16	0.04	0.01
612	9	100-yr	612 - Parch	160.00	105.00	43.00	47.92	45.22	47.93	0.000160	4.92	4.58	1.36	203.03	58.86	9.16	0.11	0.04
612	9	100-yr	612-Ex	160.00	105.00	43.00	50.72	45.22	50.72	0.000026	7.72	7.38	0.75	367.95	58.86	9.16	0.05	0.01

HEC-RAS River: 612 Reach: 612 (Continued)

Reach	River Sta	Profile	Plan	Q Total (cfs)	Cum Ch Len (ft)	Min Ch El (ft)	W.S. Elev (ft)	Crit W.S. (ft)	E.G. Elev (ft)	E.G. Slope (ft/ft)	Max Chl Dpth (ft)	Hydr Depth C (ft)	Vel Chnl (ft/s)	Flow Area (sq ft)	Top Width (ft)	Top W Chnl (ft)	Froude # Chl	Shear Chan (lb/sq ft)
612	10	Lo	612 - Parch	2.00	118.00	43.00	43.45		43.46	0.003074	0.45	0.29	1.02	1.95	6.71	6.71	0.33	0.06
612	10	Lo	612-Ex	2.00	118.00	43.00	43.81		43.81	0.000217	0.81	0.58	0.42	4.73	8.12	8.12	0.10	0.01
612	10	Lo	612 - Parch	10.00	118.00	43.00	43.92		43.97	0.003057	0.92	0.69	1.76	5.69	8.27	8.27	0.37	0.12
612	10	Lo	612-Ex	10.00	118.00	43.00	44.74		44.75	0.000202	1.74	1.41	0.69	21.10	45.91	9.16	0.10	0.02
612	10	Q fish psg	612 - Parch	21.00	118.00	43.00	44.34		44.42	0.003093	1.34	1.05	2.27	9.23	8.79	8.79	0.39	0.18
612	10	Q fish psg	612-Ex	21.00	118.00	43.00	45.67		45.67	0.000061	2.67	2.33	0.53	70.50	58.86	9.16	0.06	0.01
612	10	Lo	612 - Parch	35.00	118.00	43.00	44.77		44.85	0.002210	1.77	1.44	2.33	22.51	46.44	9.16	0.34	0.17
612	10	Lo	612-Ex	35.00	118.00	43.00	47.45		47.45	0.000012	4.45	4.11	0.35	175.34	58.86	9.16	0.03	0.00
612	10	2-yr	612 - Parch	52.00	118.00	43.00	45.26		45.30	0.001020	2.26	1.92	1.92	47.24	54.79	9.16	0.24	0.11
612	10	2-yr	612-Ex	52.00	118.00	43.00	49.99		49.99	0.000004	6.99	6.65	0.27	324.96	58.86	9.16	0.02	0.00
612	10	5-yr	612 - Parch	78.00	118.00	43.00	45.93		45.95	0.000486	2.93	2.59	1.62	86.19	58.86	9.16	0.18	0.07
612	10	5-yr	612-Ex	78.00	118.00	43.00	50.22		50.23	0.000008	7.22	6.89	0.39	338.89	58.86	9.16	0.03	0.00
612	10	10-yr	612 - Parch	96.00	118.00	43.00	46.37		46.39	0.000347	3.37	3.03	1.52	111.93	58.86	9.16	0.15	0.06
612	10	10-yr	612-Ex	96.00	118.00	43.00	50.35		50.35	0.000011	7.35	7.01	0.48	346.22	58.86	9.16	0.03	0.00
612	10	25-yr	612 - Parch	121.00	118.00	43.00	46.96		46.97	0.000247	3.96	3.62	1.44	146.57	58.86	9.16	0.13	0.05
612	10	25-yr	612-Ex	121.00	118.00	43.00	50.50		50.50	0.000016	7.50	7.16	0.58	355.16	58.86	9.16	0.04	0.01
612	10	50-yr	612 - Parch	140.00	118.00	43.00	47.41		47.42	0.000200	4.41	4.07	1.40	173.04	58.86	9.16	0.12	0.04
612	10	50-yr	612-Ex	140.00	118.00	43.00	50.58		50.58	0.000021	7.58	7.24	0.67	359.53	58.86	9.16	0.04	0.01
612	10	100-yr	612 - Parch	160.00	118.00	43.00	47.92		47.93	0.000160	4.92	4.58	1.36	203.15	58.86	9.16	0.11	0.04
612	10	100-yr	612-Ex	160.00	118.00	43.00	50.72		50.72	0.000026	7.72	7.38	0.75	367.96	58.86	9.16	0.05	0.01
612	11	Lo	612 - Parch	2.00	146.00	42.51	43.48		43.48	0.000267	0.97	0.67	0.50	4.09	7.34	5.93	0.11	0.01
612	11	Lo	612-Ex	2.00	146.00	42.51	43.81		43.81	0.000065	1.30	1.01	0.32	7.14	11.06	5.93	0.06	0.00
612	11	Lo	612 - Parch	10.00	146.00	42.51	43.99		44.02	0.000874	1.48	1.19	1.31	9.31	13.07	5.93	0.21	0.06
612	11	Lo	612-Ex	10.00	146.00	42.51	44.75		44.75	0.000113	2.24	1.94	0.66	23.39	29.14	5.93	0.08	0.01
612	11	Q fish psg	612 - Parch	21.00	146.00	42.51	44.43		44.47	0.001087	1.92	1.62	1.81	15.88	16.13	5.93	0.25	0.10
612	11	Q fish psg	612-Ex	21.00	146.00	42.51	45.67		45.67	0.000072	3.16	2.86	0.68	56.85	38.96	5.93	0.07	0.01
612	11	Lo	612 - Parch	35.00	146.00	42.51	44.84		44.89	0.001122	2.33	2.03	2.13	26.09	31.03	5.93	0.26	0.13
612	11	Lo	612-Ex	35.00	146.00	42.51	47.45		47.45	0.000021	4.94	4.64	0.51	126.20	38.96	5.93	0.04	0.01
612	11	2-yr	612 - Parch	52.00	146.00	42.51	45.28		45.33	0.000937	2.77	2.48	2.22	41.86	38.96	5.93	0.25	0.13
612	11	2-yr	612-Ex	52.00	146.00	42.51	49.99		49.99	0.000008	7.48	7.18	0.42	225.24	38.96	5.93	0.03	0.00
612	11	5-yr	612 - Parch	78.00	146.00	42.51	45.93		45.98	0.000628	3.42	3.13	2.13	67.34	38.96	5.93	0.21	0.11
612	11	5-yr	612-Ex	78.00	146.00	42.51	50.22		50.23	0.000017	7.71	7.42	0.61	234.44	38.96	5.93	0.04	0.01
612	11	10-yr	612 - Parch	96.00	146.00	42.51	46.37		46.41	0.000510	3.86	3.56	2.09	84.22	38.96	5.93	0.20	0.10
612	11	10-yr	612-Ex	96.00	146.00	42.51	50.35		50.35	0.000024	7.84	7.54	0.74	239.28	38.96	5.93	0.05	0.01
612	11	25-yr	612 - Parch	121.00	146.00	42.51	46.95		46.99	0.000406	4.44	4.15	2.06	107.04	38.96	5.93	0.18	0.09
612	11	25-yr	612-Ex	121.00	146.00	42.51	50.50		50.51	0.000035	7.99	7.69	0.91	245.17	38.96	5.93	0.06	0.02
612	11	50-yr	612 - Parch	140.00	146.00	42.51	47.40		47.44	0.000349	4.89	4.60	2.05	124.50	38.96	5.93	0.17	0.09
612	11	50-yr	612-Ex	140.00	146.00	42.51	50.57		50.58	0.000045	8.06	7.77	1.04	248.04	38.96	5.93	0.07	0.02
612	11	100-yr	612 - Parch	160.00	146.00	42.51	47.91		47.94	0.000294	5.40	5.11	2.02	144.39	38.96	5.93	0.16	0.08
612	11	100-yr	612-Ex	160.00	146.00	42.51	50.72		50.73	0.000055	8.21	7.91	1.17	253.60	38.96	5.93	0.07	0.02

Tributary 647+20 HEC-RAS

Companion 2006 Stream and Habitat Inventory (S&HI) station 670+00
Model based on ADOT&PF project datum

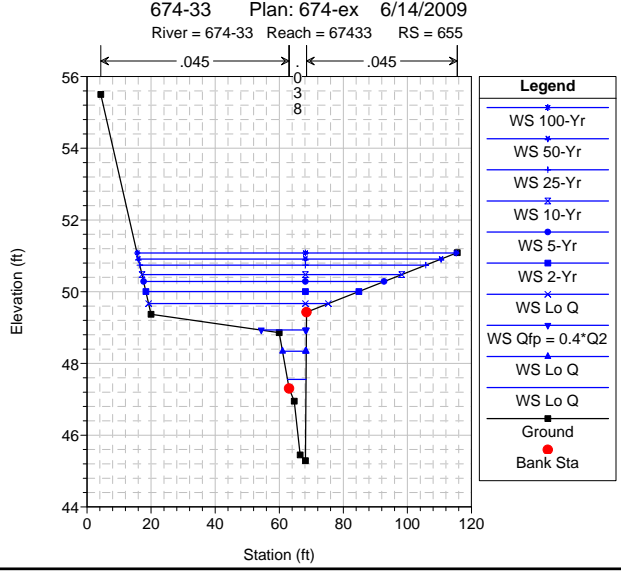
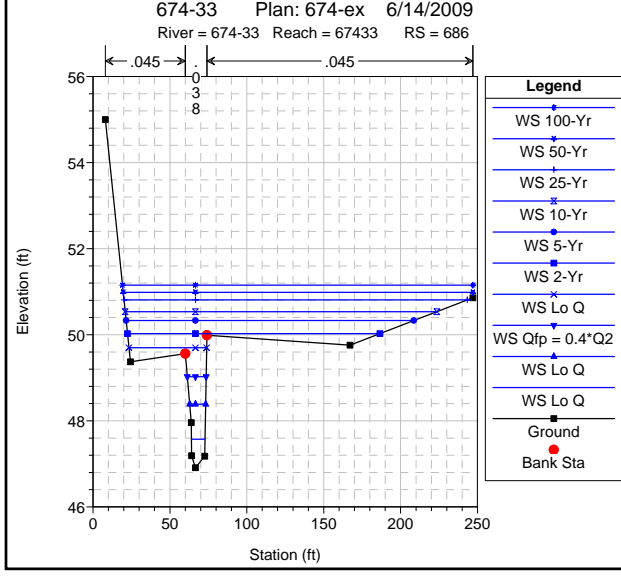
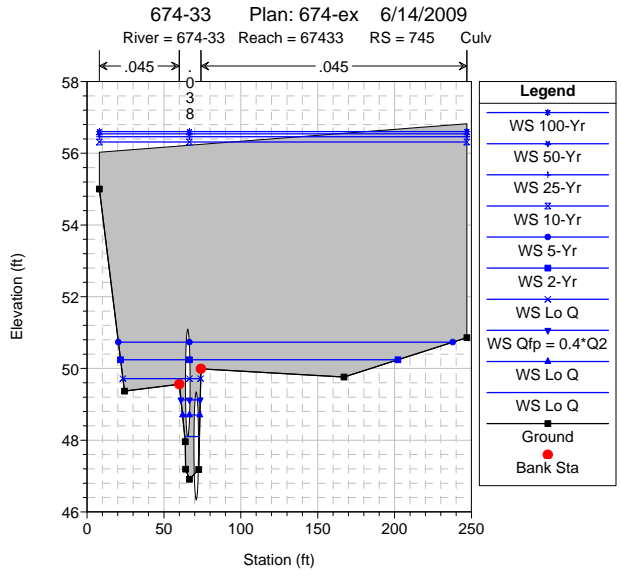
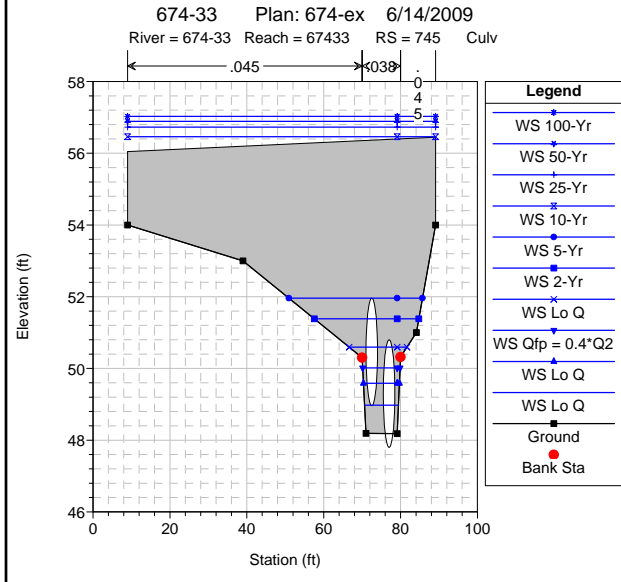
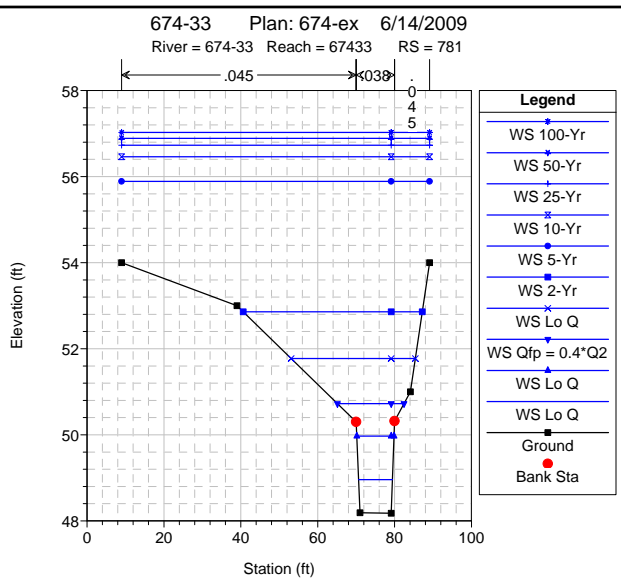
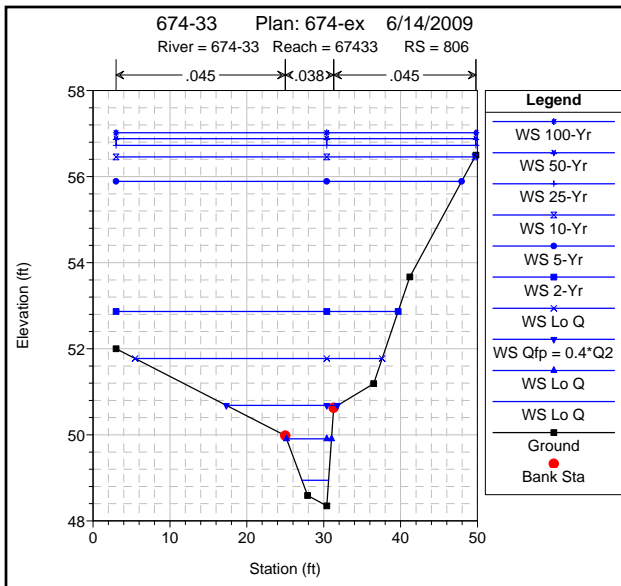

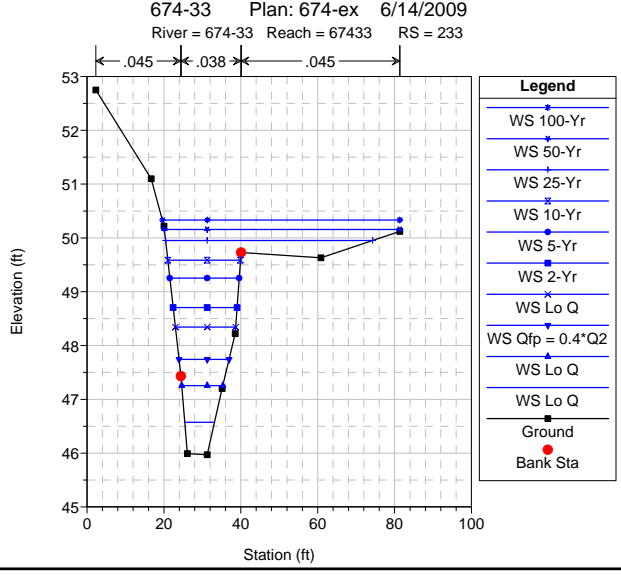
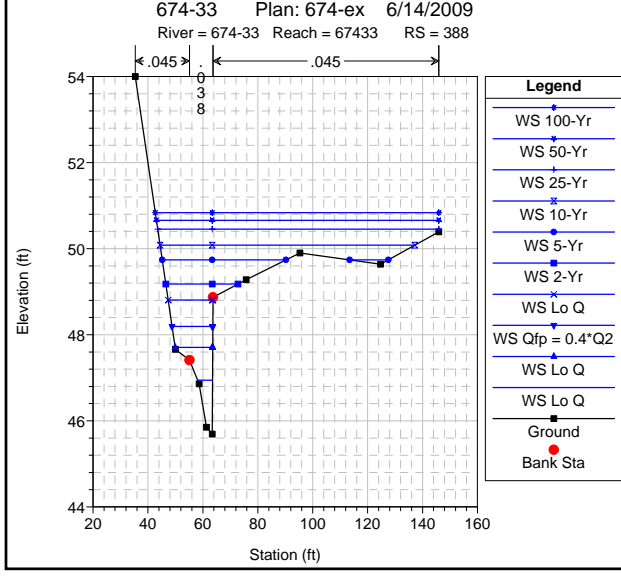
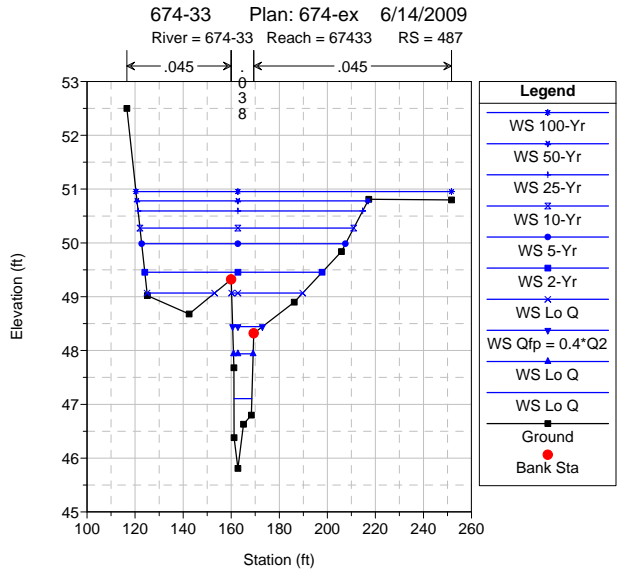
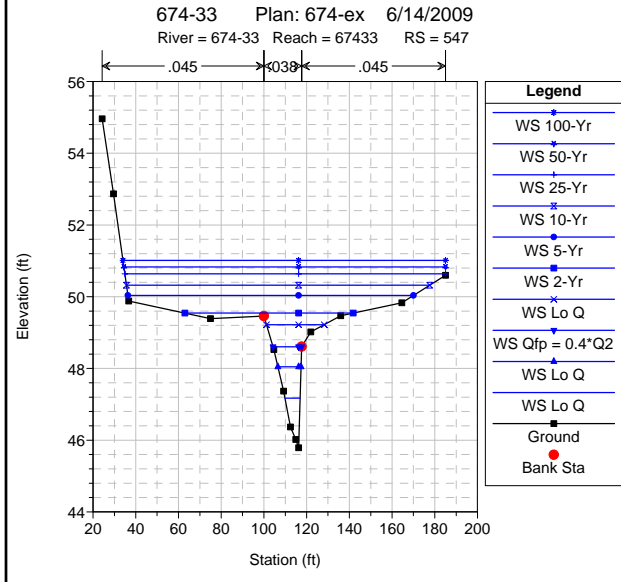
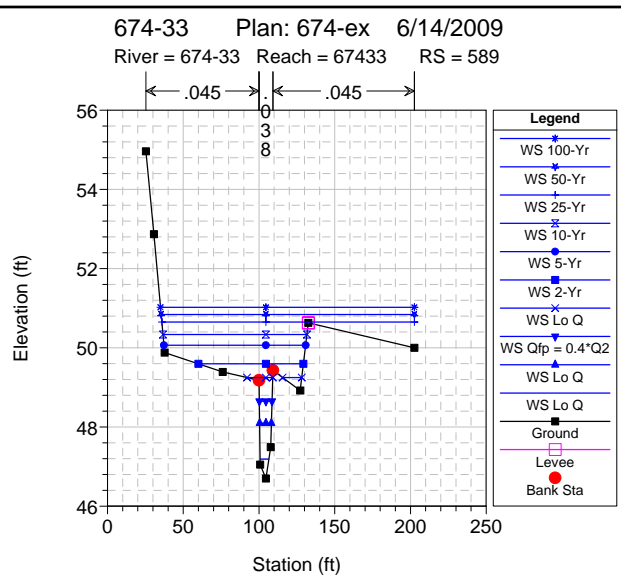
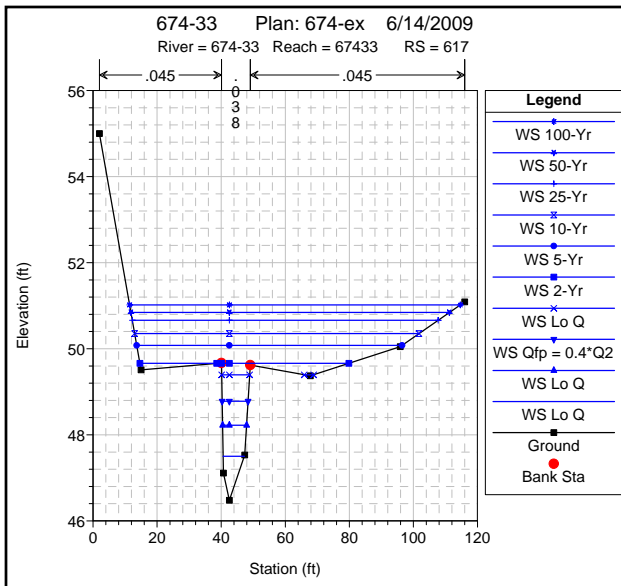

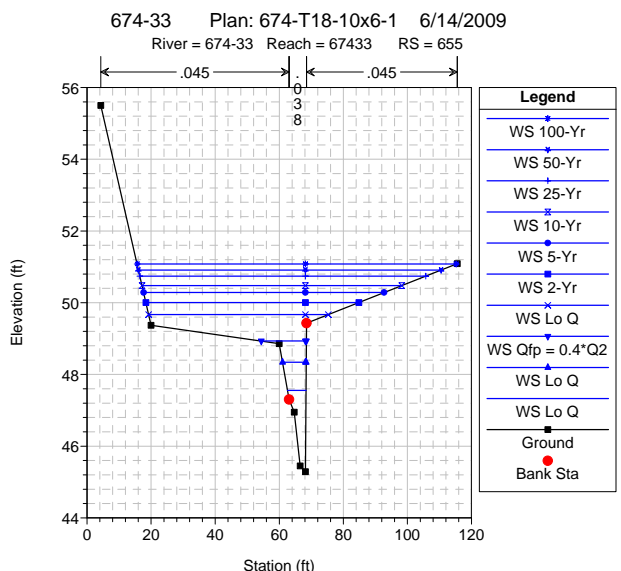
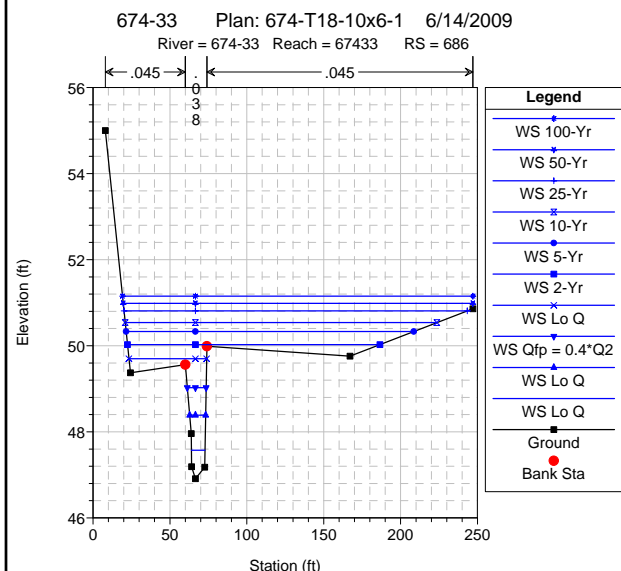
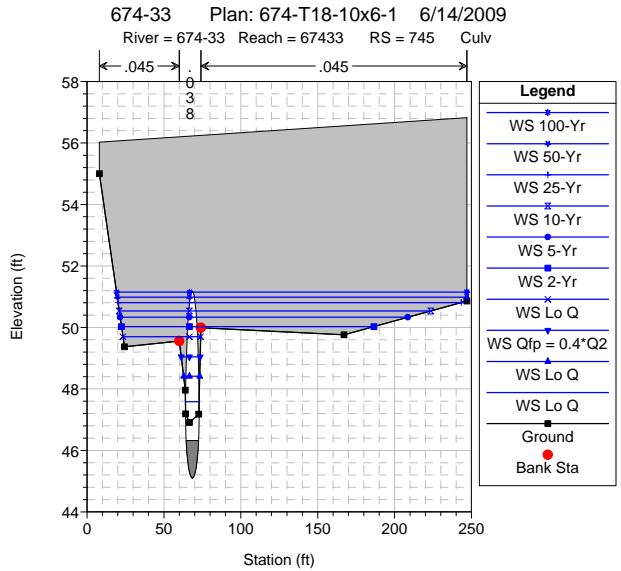
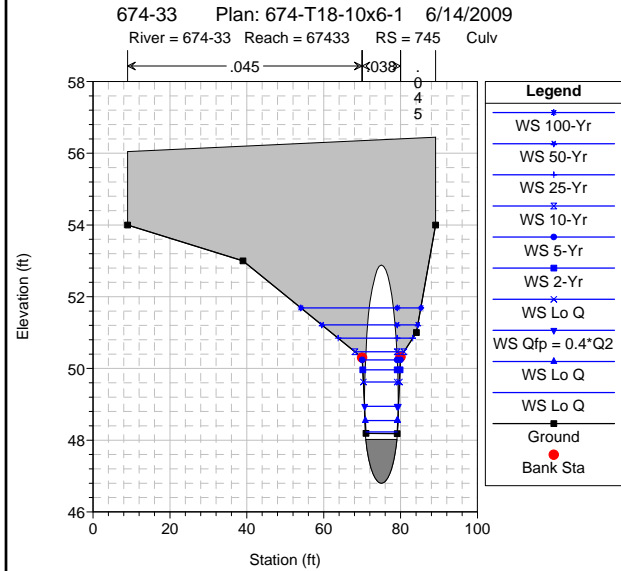
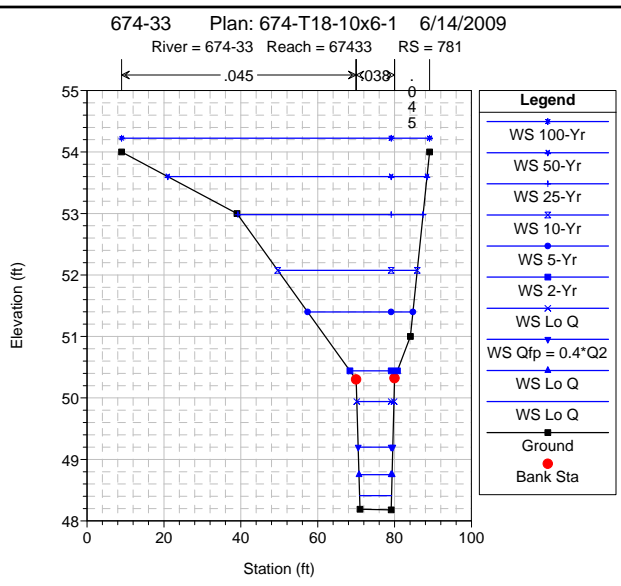
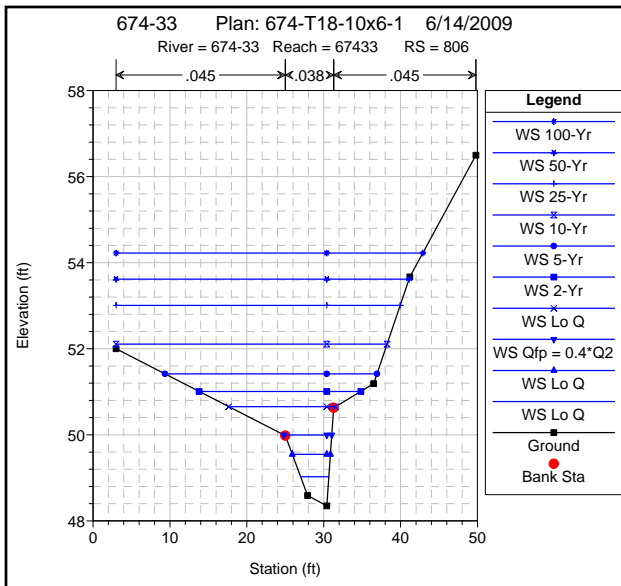

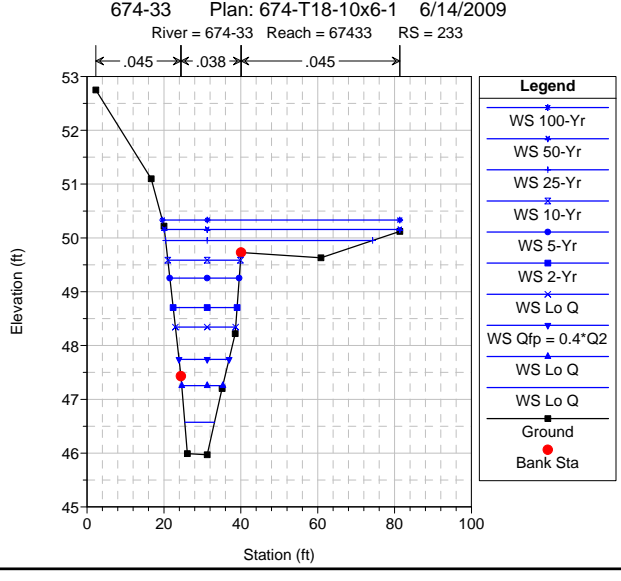
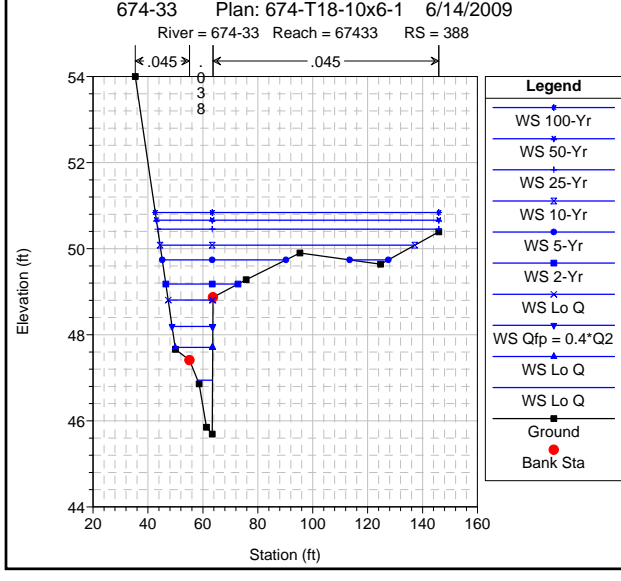
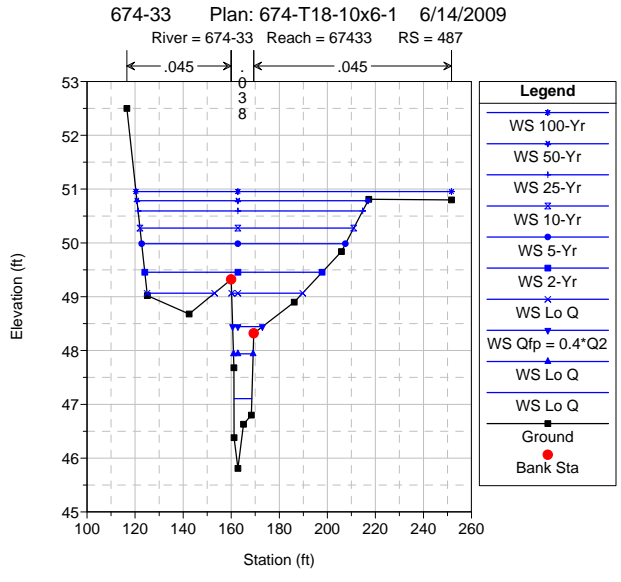
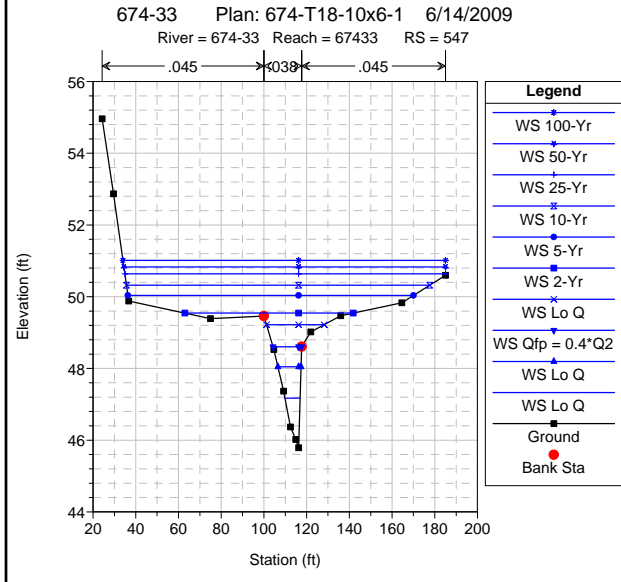
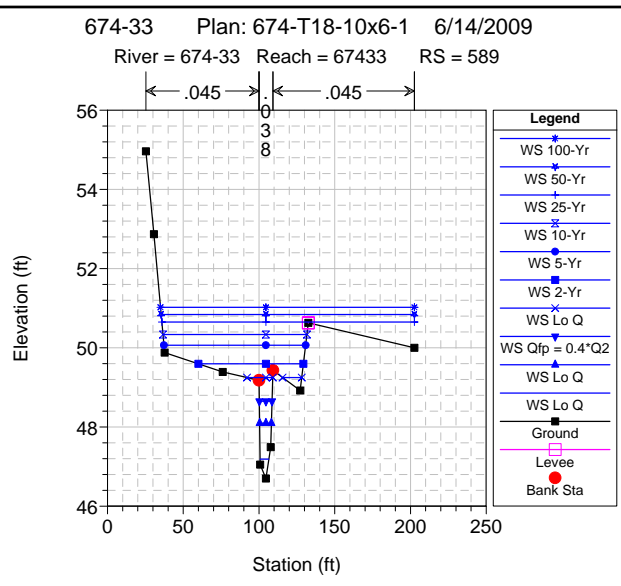
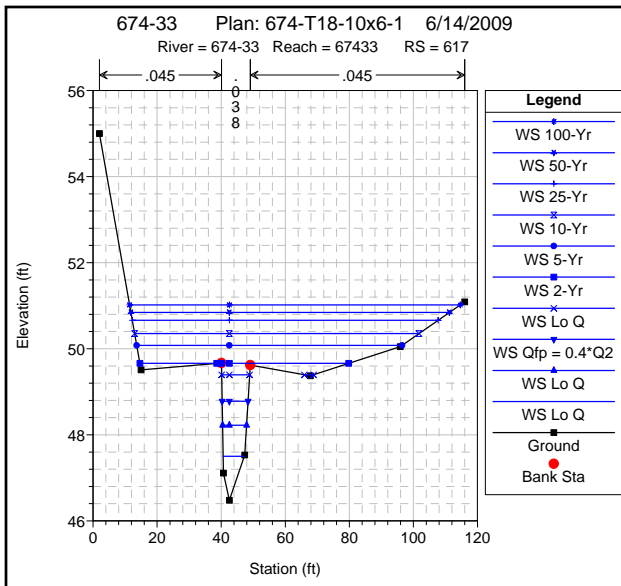

HEC-RAS River: 674-33 Reach: 67433

Reach	River Sta	Profile	Plan	Q Total (cfs)	Cum Ch Len (ft)	Min Ch El (ft)	W.S. Elev (ft)	Crit W.S. (ft)	E.G. Elev (ft)	E.G. Slope (ft/ft)	Max Chl Dpth (ft)	Hydr Depth C (ft)	Vel Chnl (ft/s)	Flow Area (sq ft)	Top Width (ft)	Top W Chnl (ft)	Froude # Chl	Shear Chan (lb/sq ft)
67433	233	Lo Q	674-ex	5.00		45.97	46.57	46.27	46.60	0.003002	0.60	0.49	1.31	3.83	7.74	7.74	0.33	0.09
67433	233	Lo Q	674-T1	5.00		45.97	46.57	46.27	46.60	0.003002	0.60	0.49	1.31	3.83	7.74	7.74	0.33	0.09
67433	233	Lo Q	674-ex	20.00		45.97	47.25	46.68	47.31	0.003002	1.28	0.94	1.98	10.10	10.70	10.70	0.36	0.17
67433	233	Lo Q	674-T1	20.00		45.97	47.25	46.68	47.31	0.003002	1.28	0.94	1.98	10.10	10.70	10.70	0.36	0.17
67433	233	Qfp = 0.4*Q2	674-ex	38.00		45.97	47.74	47.00	47.83	0.003002	1.77	1.26	2.40	15.90	13.04	12.54	0.38	0.22
67433	233	Qfp = 0.4*Q2	674-T1	38.00		45.97	47.74	47.00	47.83	0.003001	1.77	1.26	2.40	15.90	13.04	12.54	0.38	0.22
67433	233	Lo Q	674-ex	70.00		45.97	48.34	47.42	48.47	0.003004	2.37	1.68	2.90	24.57	15.70	14.26	0.39	0.30
67433	233	Lo Q	674-T1	70.00		45.97	48.34	47.42	48.47	0.003004	2.37	1.68	2.90	24.57	15.70	14.26	0.39	0.30
67433	233	2-Yr	674-ex	96.00		45.97	48.71	47.69	48.87	0.003001	2.74	1.99	3.24	30.46	16.65	14.63	0.40	0.35
67433	233	2-Yr	674-T1	96.00		45.97	48.71	47.69	48.87	0.003001	2.74	1.99	3.24	30.46	16.65	14.63	0.40	0.35
67433	233	5-Yr	674-ex	142.00		45.97	49.25	48.10	49.46	0.003000	3.28	2.46	3.70	39.97	18.06	15.18	0.42	0.42
67433	233	5-Yr	674-T1	142.00		45.97	49.25	48.10	49.46	0.003000	3.28	2.46	3.70	39.97	18.06	15.18	0.42	0.42
67433	233	10-Yr	674-ex	174.00		45.97	49.59	48.33	49.82	0.003006	3.62	2.74	3.95	46.11	18.92	15.51	0.42	0.47
67433	233	10-Yr	674-T1	174.00		45.97	49.59	48.33	49.82	0.003006	3.62	2.74	3.95	46.11	18.92	15.51	0.42	0.47
67433	233	25-Yr	674-ex	220.00		45.97	49.95	48.62	50.22	0.003002	3.98	3.07	4.26	60.96	53.87	15.66	0.43	0.53
67433	233	25-Yr	674-T1	220.00		45.97	49.95	48.62	50.22	0.003002	3.98	3.07	4.26	60.96	53.87	15.66	0.43	0.53
67433	233	50-Yr	674-ex	255.00		45.97	50.16	48.82	50.43	0.003002	4.19	3.28	4.45	72.86	61.27	15.66	0.43	0.56
67433	233	50-Yr	674-T1	255.00		45.97	50.16	48.82	50.43	0.003002	4.19	3.28	4.45	72.86	61.27	15.66	0.43	0.56
67433	233	100-Yr	674-ex	291.00		45.97	50.33	49.02	50.62	0.003004	4.36	3.46	4.61	83.75	61.79	15.66	0.44	0.59
67433	233	100-Yr	674-T1	291.00		45.97	50.33	49.02	50.62	0.003004	4.36	3.46	4.61	83.75	61.79	15.66	0.44	0.59
67433	388	Lo Q	674-ex	5.00	155.00	45.69	46.95		46.97	0.001883	1.26	0.76	1.22	4.10	5.40	5.40	0.25	0.07
67433	388	Lo Q	674-T1	5.00	155.00	45.69	46.95		46.97	0.001883	1.26	0.76	1.22	4.10	5.40	5.40	0.25	0.07
67433	388	Lo Q	674-ex	20.00	155.00	45.69	47.71		47.77	0.002853	2.02	1.16	2.00	10.67	13.67	8.40	0.33	0.17
67433	388	Lo Q	674-T1	20.00	155.00	45.69	47.71		47.77	0.002851	2.02	1.16	2.00	10.67	13.67	8.40	0.33	0.17
67433	388	Qfp = 0.4*Q2	674-ex	38.00	155.00	45.69	48.19		48.28	0.002777	2.50	1.64	2.41	17.62	14.84	8.45	0.33	0.22
67433	388	Qfp = 0.4*Q2	674-T1	38.00	155.00	45.69	48.19		48.28	0.002783	2.50	1.64	2.41	17.61	14.83	8.45	0.33	0.22
67433	388	Lo Q	674-ex	70.00	155.00	45.69	48.81		48.92	0.002863	3.12	2.24	2.92	27.15	16.30	8.50	0.34	0.29
67433	388	Lo Q	674-T1	70.00	155.00	45.69	48.81		48.92	0.002865	3.12	2.24	2.92	27.15	16.30	8.50	0.34	0.29
67433	388	2-Yr	674-ex	96.00	155.00	45.69	49.18		49.32	0.002909	3.49	2.62	3.25	34.83	26.31	8.51	0.35	0.35
67433	388	2-Yr	674-T1	96.00	155.00	45.69	49.18		49.32	0.002911	3.49	2.62	3.25	34.82	26.29	8.51	0.35	0.35
67433	388	5-Yr	674-ex	142.00	155.00	45.69	49.74		49.89	0.002571	4.05	3.18	3.48	55.48	59.16	8.51	0.34	0.37
67433	388	5-Yr	674-T1	142.00	155.00	45.69	49.74		49.89	0.002571	4.05	3.18	3.48	55.46	59.13	8.51	0.34	0.37
67433	388	10-Yr	674-ex	174.00	155.00	45.69	50.08		50.20	0.002077	4.39	3.52	3.34	83.49	92.75	8.51	0.31	0.33
67433	388	10-Yr	674-T1	174.00	155.00	45.69	50.08		50.20	0.002076	4.39	3.52	3.34	83.52	92.75	8.51	0.31	0.33
67433	388	25-Yr	674-ex	220.00	155.00	45.69	50.45		50.54	0.001550	4.76	3.89	3.09	120.14	102.33	8.51	0.28	0.28
67433	388	25-Yr	674-T1	220.00	155.00	45.69	50.45		50.54	0.001549	4.76	3.89	3.09	120.18	102.33	8.51	0.28	0.27
67433	388	50-Yr	674-ex	255.00	155.00	45.69	50.66		50.74	0.001390	4.97	4.10	3.03	141.21	102.81	8.51	0.26	0.26
67433	388	50-Yr	674-T1	255.00	155.00	45.69	50.66		50.74	0.001388	4.97	4.10	3.03	141.31	102.81	8.51	0.26	0.26
67433	388	100-Yr	674-ex	291.00	155.00	45.69	50.84		50.92	0.001308	5.15	4.27	3.02	159.61	103.22	8.51	0.26	0.26
67433	388	100-Yr	674-T1	291.00	155.00	45.69	50.84		50.92	0.001307	5.15	4.28	3.02	159.66	103.22	8.51	0.26	0.25
67433	487	Lo Q	674-ex	5.00	254.00	45.81	47.11		47.12	0.001339	1.30	0.67	1.00	4.99	7.40	7.40	0.22	0.05
67433	487	Lo Q	674-T1	5.00	254.00	45.81	47.11		47.12	0.001339	1.30	0.67	1.00	4.99	7.40	7.40	0.22	0.05
67433	487	Lo Q	674-ex	20.00	254.00	45.81	47.94		47.99	0.001778	2.13	1.40	1.75	11.40	8.14	8.14	0.26	0.12
67433	487	Lo Q	674-T1	20.00	254.00	45.81	47.94		47.99	0.001777	2.13	1.40	1.75	11.40	8.14	8.14	0.26	0.12
67433	487	Qfp = 0.4*Q2	674-ex	38.00	254.00	45.81	48.45		48.54	0.002517	2.64	1.80	2.42	15.91	12.38	8.74	0.32	0.22
67433	487	Qfp = 0.4*Q2	674-T1	38.00	254.00	45.81	48.44		48.54	0.002519	2.63	1.80	2.42	15.91	12.37	8.74	0.32	0.22
67433	487	Lo Q	674-ex	70.00	254.00	45.81	49.07		49.17	0.002459	3.26	2.32	2.80	35.10	57.65	9.17	0.32	0.27
67433	487	Lo Q	674-T1	70.00	254.00	45.81	49.07		49.17	0.002460	3.26	2.32	2.81	35.09	57.64	9.17	0.32	0.27
67433	487	2-Yr	674-ex	96.00	254.00	45.81	49.45		49.52	0.001669	3.64	2.66	2.52	61.03	73.77	9.35	0.27	0.21
67433	487	2-Yr	674-T1	96.00	254.00	45.81	49.45		49.52	0.001671	3.64	2.66	2.52	61.00	73.76	9.35	0.27	0.21
67433	487	5-Yr	674-ex	142.00	254.00	45.81	49.98		50.03	0.001013	4.17	3.19	2.22	103.32	84.81	9.35	0.22	0.15
67433	487	5-Yr	674-T1	142.00	254.00	45.81	49.98		50.03	0.001013	4.17	3.19	2.22	103.31	84.80	9.35	0.22	0.15
67433	487	10-Yr	674-ex	174.00	254.00	45.81	50.28		50.32	0.000839	4.47	3.48	2.14	128.73	88.96	9.35	0.20	0.14
67433	487	10-Yr	674-T1	174.00	254.00	45.81	50.28		50.32	0.000839	4.47	3.48	2.14	128.75	88.96	9.35	0.20	0.14
67433	487	25-Yr	674-ex	220.00	254.00	45.81	50.59		50.63	0.000764	4.78	3.80	2.17	157.70	93.47	9.35	0.20	0.14
67433	487	25-Yr	674-T1	220.00	254.00	45.81	50.59		50.63	0.000764	4.78	3.80	2.16	157.73	93.47	9.35	0.20	0.14
67433	487	50-Yr	674-ex	255.00	254.00	45.81	50.78		50.82	0.000761	4.97	3.99	2.23	175.52	96.13	9.35	0.20	0.14
67433	487	50-Yr	674-T1	255.00	254.00	45.81	50.78		50.82	0.000760	4.97	3.99	2.23	175.59	96.14	9.35	0.20	0.14
67433	487	100-Yr	674-ex	291.00	254.00	45.81	50.95		51.00	0.000886	5.14	4.16	2.48	197.14	131.27	9.35	0.21	0.17
67433	487	100-Yr	674-T1	291.00	254.00	45.81	50.95		51.00	0.000886	5.14	4.16	2.48	197.19	131.27	9.35	0.21	0.17
67433	547	Lo Q	674-ex	5.00	314.00	45.79	47.17		47.18	0.000827	1.38	0.79	0.88	5.66	7.13	7.13	0.17	0.04

HEC-RAS River: 674-33 Reach: 67433 (Continued)

Reach	River Sta	Profile	Plan	Q Total (cfs)	Cum Ch Len (ft)	Min Ch El (ft)	W.S. Elev (ft)	Crit W.S. (ft)	E.G. Elev (ft)	E.G. Slope (ft/ft)	Max Chl Dpth (ft)	Hydr Depth C (ft)	Vel Chnl (ft/s)	Flow Area (sq ft)	Top Width (ft)	Top W Chnl (ft)	Froude # Chl	Shear Chan (lb/sq ft)
67433	547	Lo Q	674-T1	5.00	314.00	45.79	47.17		47.18	0.000827	1.38	0.79	0.88	5.66	7.13	7.13	0.17	0.04
67433	547	Lo Q	674-ex	20.00	314.00	45.79	48.04		48.08	0.001312	2.25	1.24	1.49	13.46	10.86	10.86	0.24	0.09
67433	547	Lo Q	674-T1	20.00	314.00	45.79	48.04		48.08	0.001312	2.25	1.24	1.49	13.46	10.86	10.86	0.24	0.09
67433	547	Qfp = 0.4*Q2	674-ex	38.00	314.00	45.79	48.60		48.66	0.001616	2.81	1.51	1.88	20.24	13.43	13.43	0.27	0.13
67433	547	Qfp = 0.4*Q2	674-T1	38.00	314.00	45.79	48.60		48.66	0.001617	2.81	1.51	1.88	20.23	13.42	13.42	0.27	0.13
67433	547	Lo Q	674-ex	70.00	314.00	45.79	49.22		49.30	0.001931	3.43	1.79	2.33	31.84	27.03	16.50	0.31	0.19
67433	547	Lo Q	674-T1	70.00	314.00	45.79	49.22		49.30	0.001931	3.43	1.79	2.33	31.83	27.02	16.49	0.31	0.19
67433	547	2-Yr	674-ex	96.00	314.00	45.79	49.54		49.64	0.002008	3.75	1.98	2.56	46.41	78.79	17.68	0.32	0.22
67433	547	2-Yr	674-T1	96.00	314.00	45.79	49.54		49.64	0.002009	3.75	1.98	2.56	46.39	78.75	17.68	0.32	0.22
67433	547	5-Yr	674-ex	142.00	314.00	45.79	50.04		50.10	0.001184	4.25	2.47	2.28	102.39	133.71	17.68	0.26	0.16
67433	547	5-Yr	674-T1	142.00	314.00	45.79	50.04		50.10	0.001184	4.25	2.47	2.28	102.38	133.71	17.68	0.26	0.16
67433	547	10-Yr	674-ex	174.00	314.00	45.79	50.32		50.36	0.000840	4.53	2.76	2.06	141.76	141.98	17.68	0.22	0.13
67433	547	10-Yr	674-T1	174.00	314.00	45.79	50.32		50.37	0.000840	4.53	2.76	2.06	141.78	141.98	17.68	0.22	0.13
67433	547	25-Yr	674-ex	220.00	314.00	45.79	50.64		50.67	0.000652	4.85	3.08	1.96	188.22	150.10	17.68	0.20	0.11
67433	547	25-Yr	674-T1	220.00	314.00	45.79	50.64		50.67	0.000651	4.85	3.08	1.95	188.26	150.10	17.68	0.20	0.11
67433	547	50-Yr	674-ex	255.00	314.00	45.79	50.83		50.86	0.000588	5.04	3.27	1.93	216.80	150.56	17.68	0.19	0.11
67433	547	50-Yr	674-T1	255.00	314.00	45.79	50.83		50.86	0.000587	5.04	3.27	1.93	216.91	150.56	17.68	0.19	0.11
67433	547	100-Yr	674-ex	291.00	314.00	45.79	51.01		51.04	0.000543	5.22	3.45	1.92	244.12	150.99	17.68	0.18	0.10
67433	547	100-Yr	674-T1	291.00	314.00	45.79	51.01		51.04	0.000542	5.22	3.45	1.92	244.17	150.99	17.68	0.18	0.10
67433	589	Lo Q	674-ex	5.00	356.00	46.70	47.19	47.19	47.33	0.032570	0.49	0.29	3.02	1.66	5.77	5.77	0.99	0.57
67433	589	Lo Q	674-T1	5.00	356.00	46.70	47.19	47.19	47.33	0.032570	0.49	0.29	3.02	1.66	5.77	5.77	0.99	0.57
67433	589	Lo Q	674-ex	20.00	356.00	46.70	48.10	47.61	48.19	0.004545	1.40	1.04	2.47	8.09	7.76	7.76	0.43	0.26
67433	589	Lo Q	674-T1	20.00	356.00	46.70	48.10	47.61	48.19	0.004544	1.40	1.04	2.47	8.09	7.76	7.76	0.43	0.26
67433	589	Qfp = 0.4*Q2	674-ex	38.00	356.00	46.70	48.65	47.95	48.79	0.004525	1.95	1.50	3.02	12.56	8.40	8.40	0.44	0.35
67433	589	Qfp = 0.4*Q2	674-T1	38.00	356.00	46.70	48.65	47.95	48.79	0.004528	1.95	1.50	3.03	12.56	8.40	8.40	0.44	0.35
67433	589	Lo Q	674-ex	70.00	356.00	46.70	49.25	48.43	49.47	0.005399	2.55	1.97	3.84	20.17	29.66	9.06	0.48	0.52
67433	589	Lo Q	674-T1	70.00	356.00	46.70	49.25	48.43	49.47	0.005400	2.55	1.97	3.84	20.16	29.64	9.06	0.48	0.52
67433	589	2-Yr	674-ex	96.00	356.00	46.70	49.59	48.75	49.78	0.004276	2.89	2.28	3.76	38.29	69.30	9.20	0.44	0.48
67433	589	2-Yr	674-T1	96.00	356.00	46.70	49.59	48.75	49.78	0.004279	2.89	2.28	3.76	38.28	69.29	9.20	0.44	0.48
67433	589	5-Yr	674-ex	142.00	356.00	46.70	50.06	49.66	50.16	0.002294	3.36	2.75	3.12	78.52	93.55	9.20	0.33	0.31
67433	589	5-Yr	674-T1	142.00	356.00	46.70	50.06	49.66	50.16	0.002295	3.36	2.75	3.12	78.51	93.55	9.20	0.33	0.31
67433	589	10-Yr	674-ex	174.00	356.00	46.70	50.34	49.79	50.41	0.001653	3.64	3.02	2.82	104.27	95.06	9.20	0.29	0.24
67433	589	10-Yr	674-T1	174.00	356.00	46.70	50.34	49.79	50.41	0.001652	3.64	3.02	2.82	104.28	95.06	9.20	0.29	0.24
67433	589	25-Yr	674-ex	220.00	356.00	46.70	50.65	49.96	50.70	0.001294	3.95	3.33	2.67	157.72	166.73	9.20	0.26	0.21
67433	589	25-Yr	674-T1	220.00	356.00	46.70	50.65	49.96	50.70	0.001293	3.95	3.33	2.67	157.76	166.73	9.20	0.26	0.21
67433	589	50-Yr	674-ex	255.00	356.00	46.70	50.84	50.04	50.89	0.001057	4.14	3.53	2.50	189.61	167.18	9.20	0.23	0.18
67433	589	50-Yr	674-T1	255.00	356.00	46.70	50.84	50.04	50.89	0.001055	4.14	3.53	2.50	189.72	167.18	9.20	0.23	0.18
67433	589	100-Yr	674-ex	291.00	356.00	46.70	51.02	50.11	51.06	0.000902	4.32	3.71	2.39	219.98	167.61	9.20	0.22	0.16
67433	589	100-Yr	674-T1	291.00	356.00	46.70	51.02	50.11	51.06	0.000902	4.32	3.71	2.39	220.04	167.61	9.20	0.22	0.16
67433	617	Lo Q	674-ex	5.00	384.00	46.48	47.50		47.53	0.002857	1.02	0.56	1.35	3.70	6.60	6.60	0.32	0.09
67433	617	Lo Q	674-T1	5.00	384.00	46.48	47.50		47.53	0.002857	1.02	0.56	1.35	3.70	6.60	6.60	0.32	0.09
67433	617	Lo Q	674-ex	20.00	384.00	46.48	48.22		48.30	0.003423	1.74	1.18	2.27	8.80	7.49	7.49	0.37	0.21
67433	617	Lo Q	674-T1	20.00	384.00	46.48	48.22		48.30	0.003423	1.74	1.18	2.27	8.80	7.49	7.49	0.37	0.21
67433	617	Qfp = 0.4*Q2	674-ex	38.00	384.00	46.48	48.78		48.91	0.003885	2.30	1.63	2.89	13.16	8.09	8.09	0.40	0.31
67433	617	Qfp = 0.4*Q2	674-T1	38.00	384.00	46.48	48.78		48.91	0.003886	2.30	1.63	2.89	13.16	8.09	8.09	0.40	0.31
67433	617	Lo Q	674-ex	70.00	384.00	46.48	49.40		49.62	0.005196	2.92	2.09	3.82	18.38	11.69	8.76	0.46	0.51
67433	617	Lo Q	674-T1	70.00	384.00	46.48	49.40		49.62	0.005196	2.92	2.09	3.82	18.37	11.69	8.76	0.46	0.51
67433	617	2-Yr	674-ex	96.00	384.00	46.48	49.66	48.78	49.95	0.006307	3.18	2.30	4.42	27.36	63.73	9.02	0.51	0.67
67433	617	2-Yr	674-T1	96.00	384.00	46.48	49.66	48.78	49.95	0.006309	3.18	2.30	4.42	27.35	63.70	9.02	0.51	0.67
67433	617	5-Yr	674-ex	142.00	384.00	46.48	50.08		50.26	0.004202	3.60	2.71	4.03	58.47	82.82	9.02	0.43	0.53
67433	617	5-Yr	674-T1	142.00	384.00	46.48	50.08		50.26	0.004204	3.60	2.71	4.03	58.46	82.82	9.02	0.43	0.53
67433	617	10-Yr	674-ex	174.00	384.00	46.48	50.35		50.48	0.002958	3.87	2.99	3.60	81.86	88.73	9.02	0.37	0.41
67433	617	10-Yr	674-T1	174.00	384.00	46.48	50.35		50.48	0.002957	3.87	2.99	3.60	81.87	88.74	9.02	0.37	0.41
67433	617	25-Yr	674-ex	220.00	384.00	46.48	50.66		50.76	0.002249	4.18	3.29	3.35	110.22	95.42	9.02	0.33	0.34
67433	617	25-Yr	674-T1	220.00	384.00	46.48	50.66		50.76	0.002248	4.18	3.29	3.35	110.25	95.42	9.02	0.33	0.34
67433	617	50-Yr	674-ex	255.00	384.00	46.48	50.84		50.93	0.002048	4.36	3.48	3.32	127.95	99.37	9.02	0.31	0.33
67433	617	50-Yr	674-T1	255.00	384.00	46.48	50.84		50.94	0.002045	4.36	3.48	3.32	128.01	99.38	9.02	0.31	0.33
67433	617	100-Yr	674-ex	291.00	384.00	46.48	51.02		51.11	0.001885	4.54	3.65	3.29	145.76	103.18	9.02	0.30	0.32
67433	617	100-Yr	674-T1	291.00	384.00	46.48	51.02		51.11	0.001884	4.54	3.65	3.29	145.80	103.19	9.02	0.30	0.32
67433	655	Lo Q	674-ex	5.00	422.00	45.29	47.56		47.56	0.000384	2.27	1.33	0.71	7.12	5.81	5.30	0.11	0.02
67433	655	Lo Q	674-T1	5.00	422.00	45.29	47.56		47.56	0.000384	2.27	1.33	0.71	7.12	5.81	5.30	0.11	0.02

HEC-RAS River: 674-33 Reach: 67433 (Continued)

Reach	River Sta	Profile	Plan	Q Total (cfs)	Cum Ch Len (ft)	Min Ch El (ft)	W.S. Elev (ft)	Crit W.S. (ft)	E.G. Elev (ft)	E.G. Slope (ft/ft)	Max Chl Dpth (ft)	Hydr Depth C (ft)	Vel Chnl (ft/s)	Flow Area (sq ft)	Top Width (ft)	Top W Chnl (ft)	Froude # Chl	Shear Chan (lb/sq ft)
67433	655	Lo Q	674-ex	20.00	422.00	45.29	48.34		48.38	0.001373	3.05	2.09	1.71	12.29	7.41	5.37	0.21	0.11
67433	655	Lo Q	674-T1	20.00	422.00	45.29	48.34		48.38	0.001373	3.05	2.09	1.71	12.29	7.41	5.37	0.21	0.11
67433	655	Qfp = 0.4*Q2	674-ex	38.00	422.00	45.29	48.93		49.02	0.002276	3.64	2.66	2.49	17.25	14.13	5.42	0.27	0.22
67433	655	Qfp = 0.4*Q2	674-T1	38.00	422.00	45.29	48.93		49.02	0.002276	3.64	2.66	2.49	17.24	14.12	5.42	0.27	0.22
67433	655	Lo Q	674-ex	70.00	422.00	45.29	49.67		49.73	0.001596	4.38	3.38	2.38	46.46	56.10	5.46	0.23	0.19
67433	655	Lo Q	674-T1	70.00	422.00	45.29	49.67		49.73	0.001596	4.38	3.38	2.38	46.45	56.09	5.46	0.23	0.19
67433	655	2-Yr	674-ex	96.00	422.00	45.29	50.01		50.05	0.001288	4.72	3.71	2.27	67.02	66.46	5.46	0.21	0.17
67433	655	2-Yr	674-T1	96.00	422.00	45.29	50.01		50.05	0.001288	4.72	3.71	2.27	67.01	66.46	5.46	0.21	0.17
67433	655	5-Yr	674-ex	142.00	422.00	45.29	50.28		50.34	0.001503	4.99	3.99	2.58	86.71	75.06	5.46	0.23	0.21
67433	655	5-Yr	674-T1	142.00	422.00	45.29	50.28		50.34	0.001503	4.99	3.99	2.58	86.71	75.06	5.46	0.23	0.21
67433	655	10-Yr	674-ex	174.00	422.00	45.29	50.48		50.54	0.001510	5.19	4.19	2.66	101.85	81.05	5.46	0.23	0.22
67433	655	10-Yr	674-T1	174.00	422.00	45.29	50.48		50.54	0.001509	5.19	4.19	2.66	101.85	81.05	5.46	0.23	0.22
67433	655	25-Yr	674-ex	220.00	422.00	45.29	50.74		50.81	0.001456	5.45	4.45	2.73	124.36	89.22	5.46	0.23	0.22
67433	655	25-Yr	674-T1	220.00	422.00	45.29	50.74		50.81	0.001455	5.45	4.45	2.73	124.38	89.23	5.46	0.23	0.22
67433	655	50-Yr	674-ex	255.00	422.00	45.29	50.91		50.98	0.001449	5.62	4.62	2.79	139.88	94.44	5.46	0.23	0.23
67433	655	50-Yr	674-T1	255.00	422.00	45.29	50.91		50.98	0.001448	5.62	4.62	2.79	139.93	94.46	5.46	0.23	0.23
67433	655	100-Yr	674-ex	291.00	422.00	45.29	51.08		51.15	0.001427	5.79	4.79	2.83	156.00	99.57	5.46	0.23	0.24
67433	655	100-Yr	674-T1	291.00	422.00	45.29	51.08		51.15	0.001426	5.79	4.79	2.83	156.03	99.58	5.46	0.23	0.24
67433	686	Lo Q	674-ex	5.00	453.00	46.91	47.57		47.59	0.002104	0.66	0.51	1.10	4.53	8.79	8.79	0.27	0.06
67433	686	Lo Q	674-T1	5.00	453.00	46.91	47.57		47.59	0.002104	0.66	0.51	1.10	4.53	8.79	8.79	0.27	0.06
67433	686	Lo Q	674-ex	20.00	453.00	46.91	48.39		48.43	0.001712	1.48	1.17	1.65	12.14	10.34	10.34	0.27	0.11
67433	686	Lo Q	674-T1	20.00	453.00	46.91	48.39		48.43	0.001712	1.48	1.17	1.65	12.14	10.34	10.34	0.27	0.11
67433	686	Qfp = 0.4*Q2	674-ex	38.00	453.00	46.91	49.03		49.09	0.001674	2.12	1.58	1.96	19.35	12.24	12.24	0.28	0.14
67433	686	Qfp = 0.4*Q2	674-T1	38.00	453.00	46.91	49.03		49.09	0.001675	2.12	1.58	1.96	19.35	12.24	12.24	0.28	0.14
67433	686	Lo Q	674-ex	70.00	453.00	46.91	49.70		49.78	0.001711	2.79	2.03	2.32	36.75	50.56	13.91	0.29	0.18
67433	686	Lo Q	674-T1	70.00	453.00	46.91	49.70		49.78	0.001711	2.79	2.03	2.32	36.74	50.56	13.91	0.29	0.18
67433	686	2-Yr	674-ex	96.00	453.00	46.91	50.03		50.09	0.001334	3.12	2.34	2.24	70.35	164.12	14.06	0.26	0.16
67433	686	2-Yr	674-T1	96.00	453.00	46.91	50.03		50.09	0.001334	3.12	2.34	2.24	70.35	164.11	14.06	0.26	0.16
67433	686	5-Yr	674-ex	142.00	453.00	46.91	50.33		50.38	0.001044	3.42	2.64	2.15	123.75	187.10	14.06	0.23	0.14
67433	686	5-Yr	674-T1	142.00	453.00	46.91	50.33		50.38	0.001044	3.42	2.64	2.15	123.75	187.09	14.06	0.23	0.14
67433	686	10-Yr	674-ex	174.00	453.00	46.91	50.54		50.57	0.000836	3.63	2.85	2.02	163.78	202.62	14.06	0.21	0.12
67433	686	10-Yr	674-T1	174.00	453.00	46.91	50.54		50.57	0.000836	3.63	2.85	2.02	163.79	202.62	14.06	0.21	0.12
67433	686	25-Yr	674-ex	220.00	453.00	46.91	50.81		50.84	0.000640	3.90	3.12	1.88	221.78	223.20	14.06	0.19	0.10
67433	686	25-Yr	674-T1	220.00	453.00	46.91	50.81		50.84	0.000640	3.90	3.12	1.88	221.81	223.21	14.06	0.19	0.10
67433	686	50-Yr	674-ex	255.00	453.00	46.91	50.98		51.01	0.000553	4.07	3.29	1.81	261.19	227.37	14.06	0.18	0.10
67433	686	50-Yr	674-T1	255.00	453.00	46.91	50.98		51.01	0.000552	4.07	3.29	1.81	261.30	227.37	14.06	0.18	0.10
67433	686	100-Yr	674-ex	291.00	453.00	46.91	51.15		51.17	0.000484	4.24	3.46	1.75	299.76	227.86	14.06	0.17	0.09
67433	686	100-Yr	674-T1	291.00	453.00	46.91	51.15		51.17	0.000483	4.24	3.46	1.75	299.82	227.86	14.06	0.17	0.09
67433	745			Culvert														
67433	781	Lo Q	674-ex	5.00	548.00	48.18	48.96	48.41	48.97	0.000653	0.78	0.74	0.76	6.55	8.79	8.79	0.16	0.03
67433	781	Lo Q	674-T1	5.00	548.00	48.18	48.41	48.41	48.52	0.036180	0.23	0.22	2.68	1.86	8.30	8.30	1.00	0.49
67433	781	Lo Q	674-ex	20.00	548.00	48.18	49.97	48.75	50.00	0.000712	1.79	1.64	1.26	15.90	9.70	9.70	0.17	0.06
67433	781	Lo Q	674-T1	20.00	548.00	48.18	48.75	48.75	49.03	0.028990	0.57	0.55	4.23	4.73	8.61	8.61	1.01	0.92
67433	781	Qfp = 0.4*Q2	674-ex	38.00	548.00	48.18	50.73	49.05	50.77	0.000749	2.55	2.34	1.60	24.93	17.34	10.00	0.18	0.09
67433	781	Qfp = 0.4*Q2	674-T1	38.00	548.00	48.18	49.20	49.05	49.50	0.015821	1.02	0.96	4.38	8.68	9.01	9.01	0.79	0.83
67433	781	Lo Q	674-ex	70.00	548.00	48.18	51.77	49.47	51.81	0.000535	3.59	3.39	1.73	51.35	32.29	10.00	0.17	0.09
67433	781	Lo Q	674-T1	70.00	548.00	48.18	49.94	49.47	50.25	0.009229	1.76	1.61	4.49	15.60	9.67	9.67	0.62	0.75
67433	781	2-Yr	674-ex	96.00	548.00	48.18	52.86	49.76	52.88	0.000254	4.68	4.47	1.44	94.26	46.59	10.00	0.12	0.06
67433	781	2-Yr	674-T1	96.00	548.00	48.18	50.44	49.76	50.78	0.007559	2.26	2.05	4.67	20.70	12.34	10.00	0.57	0.76
67433	781	5-Yr	674-ex	142.00	548.00	48.18	55.89	50.22	55.89	0.000028	7.71	7.50	0.67	316.57	80.10	10.00	0.04	0.01
67433	781	5-Yr	674-T1	142.00	548.00	48.18	51.40	50.22	51.65	0.003756	3.22	3.01	4.25	40.18	27.36	10.00	0.43	0.55
67433	781	10-Yr	674-ex	174.00	548.00	48.18	56.46	50.57	56.46	0.000028	8.28	8.07	0.70	362.26	80.10	10.00	0.04	0.01
67433	781	10-Yr	674-T1	174.00	548.00	48.18	52.08	50.57	52.25	0.002194	3.90	3.69	3.72	61.76	36.28	10.00	0.34	0.40
67433	781	25-Yr	674-ex	220.00	548.00	48.18	56.73	51.11	56.73	0.000037	8.55	8.34	0.83	383.74	80.10	10.00	0.05	0.02
67433	781	25-Yr	674-T1	220.00	548.00	48.18	52.98	51.11	53.09	0.001165	4.80	4.59	3.14	99.93	48.17	10.00	0.26	0.26
67433	781	50-Yr	674-ex	255.00	548.00	48.18	56.89	51.36	56.89	0.000045	8.71	8.50	0.93	396.45	80.10	10.00	0.06	0.02
67433	781	50-Yr	674-T1	255.00	548.00	48.18	53.60	51.36	53.69	0.000849	5.42	5.21	2.91	135.59	67.40	10.00	0.22	0.22
67433	781	100-Yr	674-ex	291.00	548.00	48.18	57.03	51.57	57.04	0.000054	8.85	8.64	1.03	407.62	80.10	10.00	0.06	0.02
67433	781	100-Yr	674-T1	291.00	548.00	48.18	54.22	51.57	54.29	0.000559	6.04	5.84	2.55	183.07	80.10	10.00	0.19	0.16
67433	806	Lo Q	674-ex	5.00	572.00	48.35	48.95	48.95	49.15	0.034232	0.60	0.40	3.59	1.39	3.48	3.48	1.00	0.75

HEC-RAS River: 674-33 Reach: 67433 (Continued)

Reach	River Sta	Profile	Plan	Q Total (cfs)	Cum Ch Len (ft)	Min Ch El (ft)	W.S. Elev (ft)	Crit W.S. (ft)	E.G. Elev (ft)	E.G. Slope (ft/ft)	Max Chl Dpth (ft)	Hydr Depth C (ft)	Vel Chnl (ft/s)	Flow Area (sq ft)	Top Width (ft)	Top W Chnl (ft)	Froude # Chl	Shear Chan (lb/sq ft)
67433	806	Lo Q	674-T1	5.00	572.00	48.35	49.03	48.95	49.16	0.019797	0.68	0.46	2.97	1.68	3.68	3.68	0.77	0.49
67433	806	674-ex	674-ex	20.00	572.00	48.35	49.91		50.09	0.009977	1.56	1.00	3.40	5.88	5.86	5.86	0.60	0.51
67433	806	Lo Q	674-T1	20.00	572.00	48.35	49.55	49.55	49.95	0.029852	1.20	0.79	5.09	3.93	4.97	4.97	1.01	1.22
67433	806	Qlp = 0.4*Q2	674-ex	38.00	572.00	48.35	50.68		50.84	0.004912	2.33	1.69	3.27	13.38	14.47	6.30	0.44	0.40
67433	806	Qlp = 0.4*Q2	674-T1	38.00	572.00	48.35	50.00	50.00	50.54	0.028163	1.65	1.06	5.92	6.42	6.24	6.05	1.01	1.51
67433	806	Lo Q	674-ex	70.00	572.00	48.35	51.77		51.84	0.001503	3.42	2.78	2.52	39.85	32.14	6.30	0.27	0.20
67433	806	Lo Q	674-T1	70.00	572.00	48.35	50.65	50.65	51.21	0.017900	2.30	1.66	6.17	12.96	13.88	6.30	0.84	1.43
67433	806	2-Yr	674-ex	96.00	572.00	48.35	52.87		52.89	0.000448	4.52	3.87	1.72	78.50	36.68	6.30	0.15	0.08
67433	806	2-Yr	674-T1	96.00	572.00	48.35	51.01	51.01	51.55	0.014525	2.66	2.02	6.32	19.15	21.03	6.30	0.78	1.41
67433	806	5-Yr	674-ex	142.00	572.00	48.35	55.89		55.90	0.000065	7.54	6.90	0.96	200.82	44.94	6.30	0.06	0.02
67433	806	5-Yr	674-T1	142.00	572.00	48.35	51.42	51.42	51.96	0.012778	3.07	2.43	6.70	29.19	27.57	6.30	0.76	1.49
67433	806	10-Yr	674-ex	174.00	572.00	48.35	56.46		56.47	0.000069	8.11	7.47	1.04	226.91	46.67	6.30	0.07	0.02
67433	806	10-Yr	674-T1	174.00	572.00	48.35	52.11		52.36	0.004951	3.76	3.12	4.93	51.23	35.24	6.30	0.49	0.74
67433	806	25-Yr	674-ex	220.00	572.00	48.35	56.72		56.74	0.000094	8.37	7.73	1.25	239.39	46.80	6.30	0.08	0.04
67433	806	25-Yr	674-T1	220.00	572.00	48.35	53.01		53.14	0.001952	4.66	4.02	3.67	83.67	36.94	6.30	0.32	0.38
67433	806	50-Yr	674-ex	255.00	572.00	48.35	56.88		56.90	0.000116	8.53	7.89	1.40	246.75	46.80	6.30	0.09	0.04
67433	806	50-Yr	674-T1	255.00	572.00	48.35	53.62		53.72	0.001289	5.27	4.63	3.27	106.57	38.10	6.30	0.27	0.29
67433	806	100-Yr	674-ex	291.00	572.00	48.35	57.02		57.04	0.000140	8.67	8.03	1.56	253.21	46.80	6.30	0.10	0.05
67433	806	100-Yr	674-T1	291.00	572.00	48.35	54.22		54.31	0.000939	5.87	5.23	3.03	130.25	39.88	6.30	0.23	0.24

Tributary 710+75 HEC-RAS

Companion 2006 Stream and Habitat Inventory (S&HI) station 731+00
Model based on ADOT&PF project datum

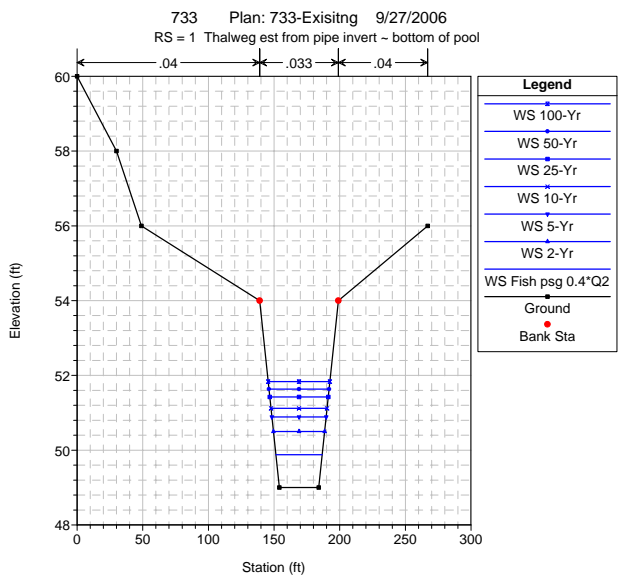
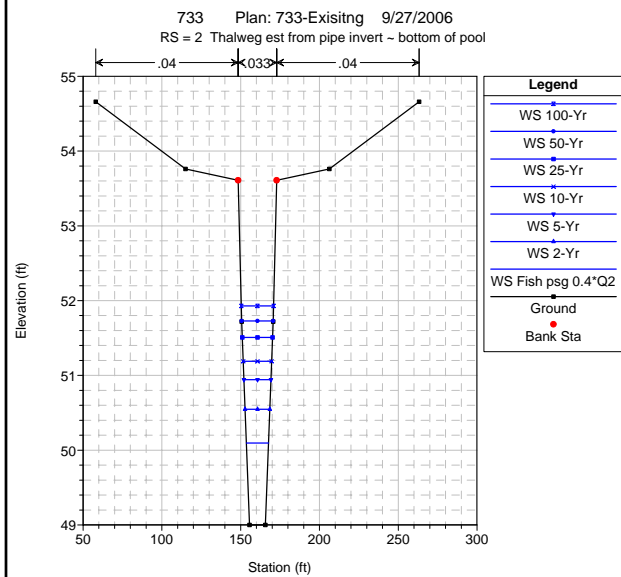
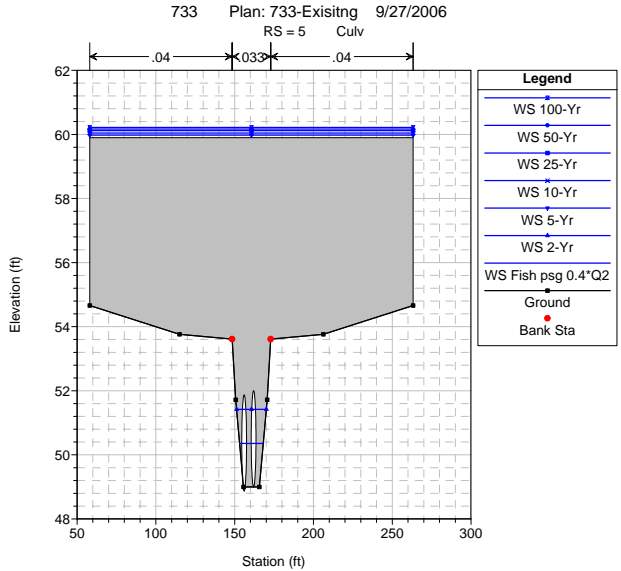
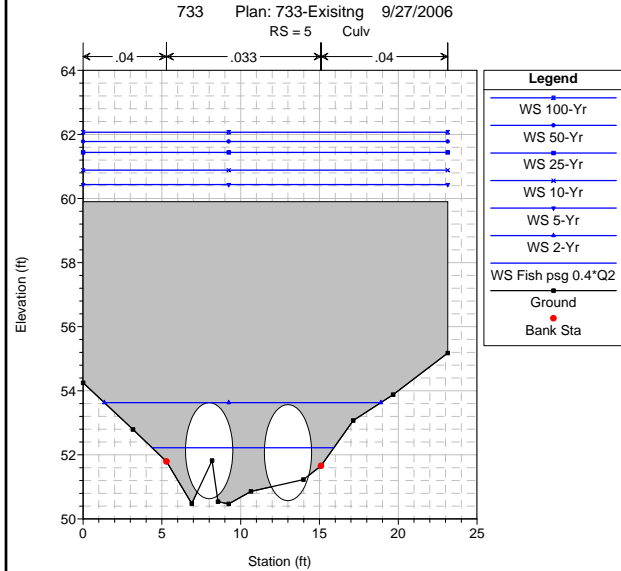
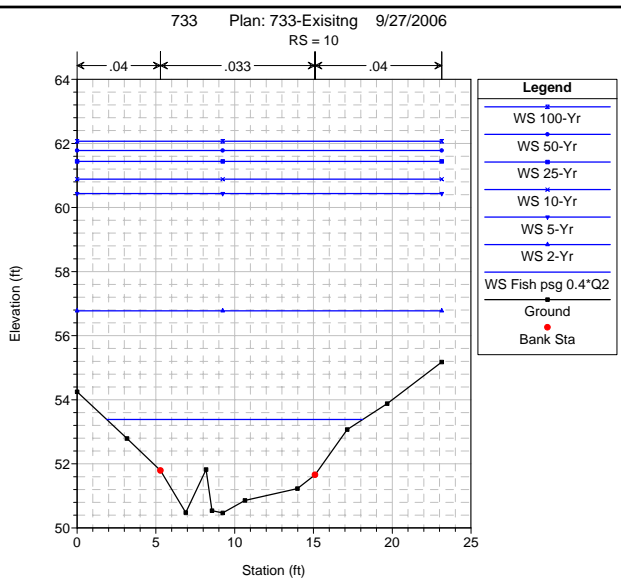
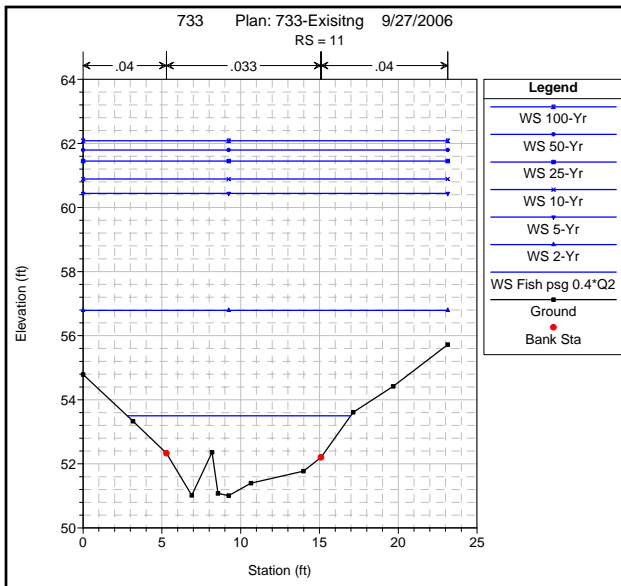

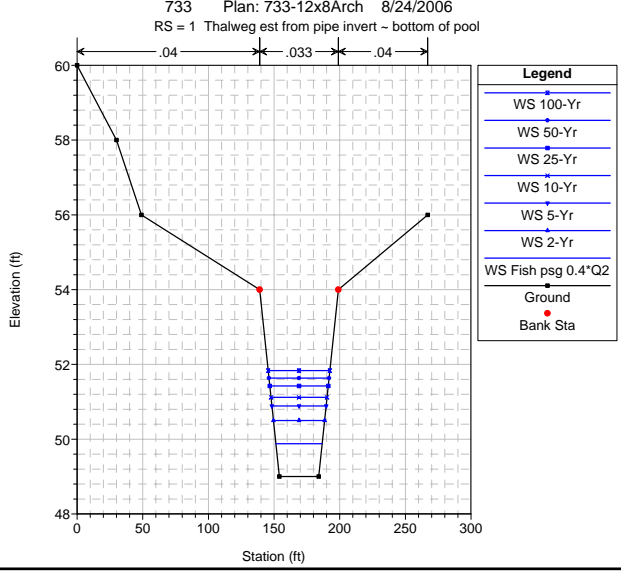
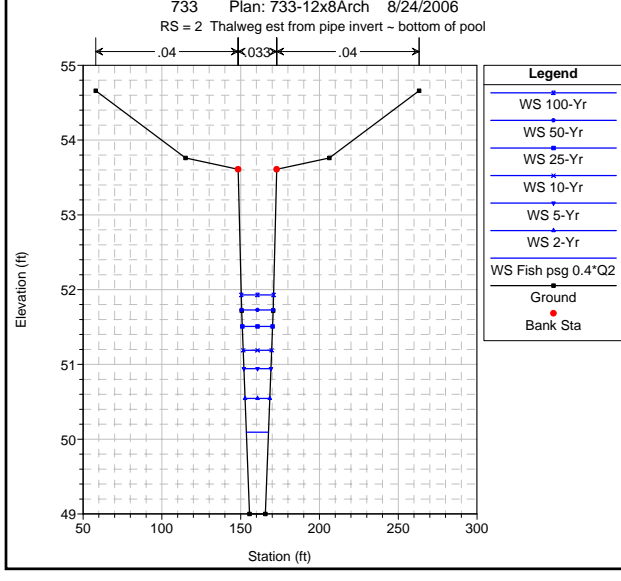
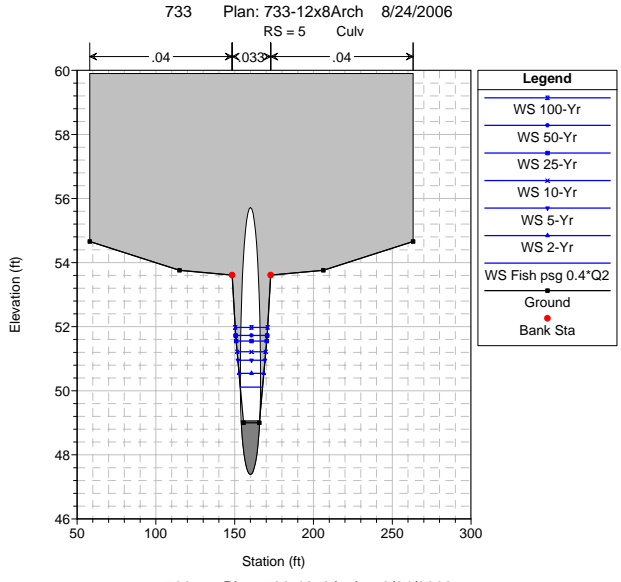
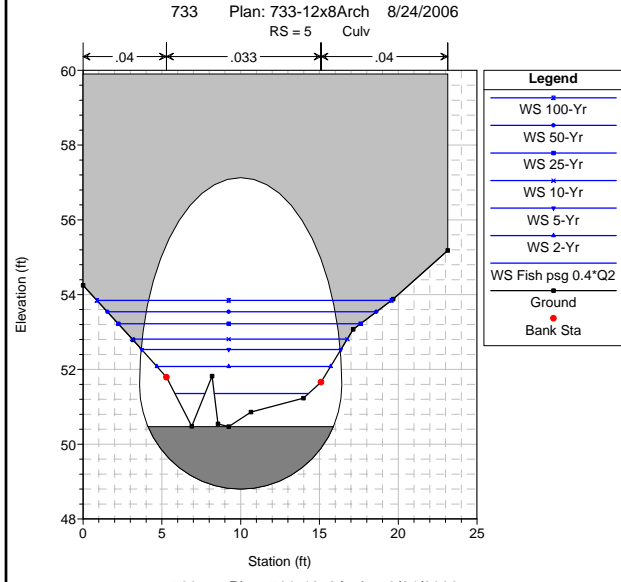
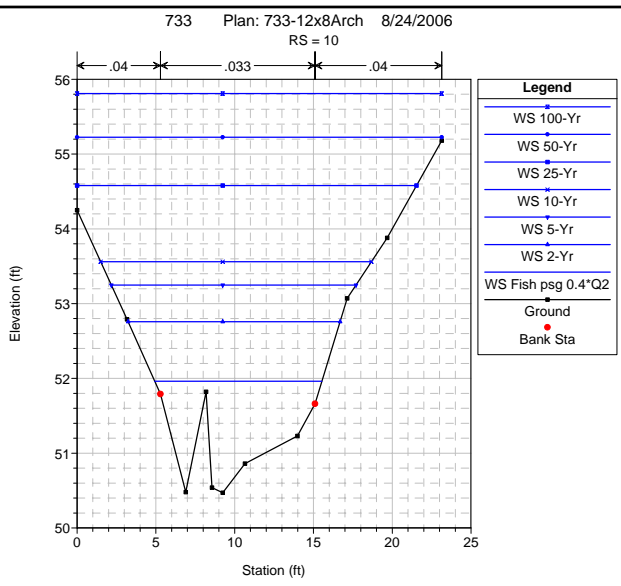
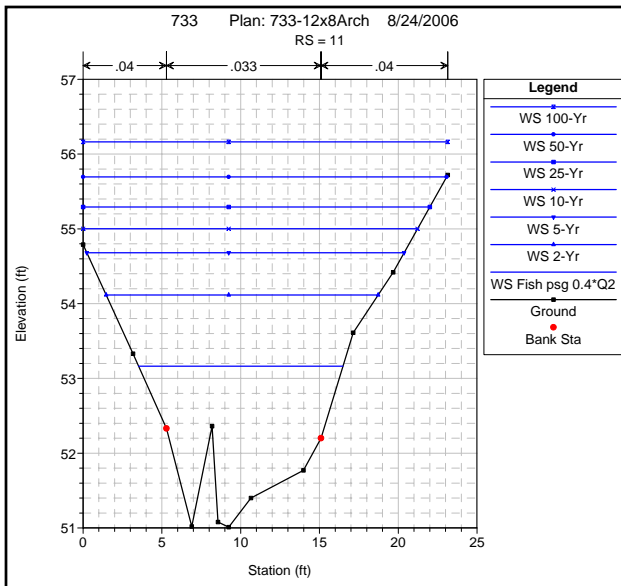

HEC-RAS River: 733 Reach: 733

Reach	River Sta	Profile	Plan	Q Total (cfs)	Cum Ch Len (ft)	Min Ch El (ft)	W.S. Elev (ft)	Crit W.S. (ft)	E.G. Elev (ft)	E.G. Slope (ft/ft)	Max Chl Dpth (ft)	Hydr Depth C (ft)	Vel Chnl (ft/s)	Flow Area (sq ft)	Top Width (ft)	Top W Chnl (ft)	Froude # Chl	Shear Chan (lb/sq ft)
733	1	5-cfs	733-Arch	5.00		49.00	49.22	49.09	49.23	0.002001	0.22	0.22	0.73	6.85	31.34	31.34	0.28	0.03
733	1	5-cfs	733-Ex	5.00		49.00	49.22	49.09	49.23	0.002001	0.22	0.22	0.73	6.85	31.34	31.34	0.28	0.03
733	1	25-cfs	733-Arch	25.00		49.00	49.58	49.28	49.61	0.002001	0.58	0.55	1.35	18.50	33.50	33.50	0.32	0.07
733	1	25-cfs	733-Ex	25.00		49.00	49.58	49.28	49.61	0.002001	0.58	0.55	1.35	18.50	33.50	33.50	0.32	0.07
733	1	Fish psg 0.4*Q2	733-Arch	50.00		49.00	49.88	49.43	49.93	0.002002	0.88	0.81	1.74	28.65	35.27	35.27	0.34	0.10
733	1	Fish psg 0.4*Q2	733-Ex	50.00		49.00	49.88	49.43	49.93	0.002002	0.88	0.81	1.74	28.65	35.27	35.27	0.34	0.10
733	1	100-cfs	733-Arch	100.00		49.00	50.32	49.68	50.40	0.002000	1.32	1.18	2.23	44.78	37.91	37.91	0.36	0.15
733	1	100-cfs	733-Ex	100.00		49.00	50.32	49.68	50.40	0.002000	1.32	1.18	2.23	44.78	37.91	37.91	0.36	0.15
733	1	2-Yr	733-Arch	125.00		49.00	50.50	49.79	50.59	0.002001	1.50	1.33	2.41	51.80	39.01	39.01	0.37	0.16
733	1	2-Yr	733-Ex	125.00		49.00	50.50	49.79	50.59	0.002001	1.50	1.33	2.41	51.80	39.01	39.01	0.37	0.16
733	1	5-Yr	733-Arch	186.00		49.00	50.89	50.02	51.01	0.002002	1.89	1.63	2.76	67.34	41.33	41.33	0.38	0.20
733	1	5-Yr	733-Ex	186.00		49.00	50.89	50.02	51.01	0.002002	1.89	1.63	2.76	67.34	41.33	41.33	0.38	0.20
733	1	10-Yr	733-Arch	228.00		49.00	51.12	50.16	51.26	0.002000	2.12	1.81	2.95	77.16	42.73	42.73	0.39	0.22
733	1	10-Yr	733-Ex	228.00		49.00	51.12	50.16	51.26	0.002000	2.12	1.81	2.95	77.16	42.73	42.73	0.39	0.22
733	1	25-Yr	733-Arch	288.00		49.00	51.42	50.35	51.58	0.002002	2.42	2.03	3.19	90.29	44.54	44.54	0.39	0.25
733	1	25-Yr	733-Ex	288.00		49.00	51.42	50.35	51.58	0.002002	2.42	2.03	3.19	90.29	44.54	44.54	0.39	0.25
733	1	50-Yr	733-Arch	334.00		49.00	51.63	50.48	51.81	0.002000	2.63	2.18	3.34	99.87	45.81	45.81	0.40	0.27
733	1	50-Yr	733-Ex	334.00		49.00	51.63	50.48	51.81	0.002000	2.63	2.18	3.34	99.87	45.81	45.81	0.40	0.27
733	1	100-Yr	733-Arch	381.00		49.00	51.84	50.62	52.02	0.002003	2.84	2.32	3.49	109.21	47.02	47.02	0.40	0.28
733	1	100-Yr	733-Ex	381.00		49.00	51.84	50.61	52.02	0.002003	2.84	2.32	3.49	109.20	47.02	47.02	0.40	0.28
733	2	5-cfs	733-Arch	5.00	95.00	49.00	49.41		49.43	0.002294	0.41	0.39	1.13	4.43	11.52	11.52	0.32	0.05
733	2	5-cfs	733-Ex	5.00	95.00	49.00	49.41		49.43	0.002294	0.41	0.39	1.13	4.43	11.52	11.52	0.32	0.05
733	2	25-cfs	733-Arch	25.00	95.00	49.00	49.82		49.93	0.005482	0.82	0.73	2.64	9.47	13.02	13.02	0.55	0.24
733	2	25-cfs	733-Ex	25.00	95.00	49.00	49.82		49.93	0.005486	0.82	0.73	2.64	9.47	13.02	13.02	0.55	0.24
733	2	Fish psg 0.4*Q2	733-Arch	50.00	95.00	49.00	50.09		50.32	0.008190	1.09	0.94	3.80	13.15	14.02	14.02	0.69	0.46
733	2	Fish psg 0.4*Q2	733-Ex	50.00	95.00	49.00	50.09		50.32	0.008187	1.09	0.94	3.80	13.15	14.02	14.02	0.69	0.46
733	2	100-cfs	733-Arch	100.00	95.00	49.00	50.43	50.33	50.91	0.012801	1.43	1.18	5.53	18.08	15.26	15.26	0.90	0.90
733	2	100-cfs	733-Ex	100.00	95.00	49.00	50.43		50.91	0.012874	1.43	1.18	5.54	18.05	15.25	15.25	0.90	0.91
733	2	2-Yr	733-Arch	125.00	95.00	49.00	50.55	50.53	51.16	0.015251	1.55	1.27	6.30	19.85	15.68	15.68	0.99	1.15
733	2	2-Yr	733-Ex	125.00	95.00	49.00	50.55	50.53	51.16	0.015166	1.55	1.27	6.29	19.89	15.69	15.69	0.98	1.14
733	2	5-Yr	733-Arch	186.00	95.00	49.00	50.94	50.94	51.72	0.014908	1.94	1.54	7.06	26.36	17.14	17.14	1.00	1.35
733	2	5-Yr	733-Ex	186.00	95.00	49.00	50.94	50.94	51.72	0.014907	1.94	1.54	7.06	26.36	17.14	17.14	1.00	1.35
733	2	10-Yr	733-Arch	228.00	95.00	49.00	51.19	51.19	52.05	0.014498	2.19	1.70	7.42	30.71	18.05	18.05	1.00	1.45
733	2	10-Yr	733-Ex	228.00	95.00	49.00	51.19	51.19	52.05	0.014499	2.19	1.70	7.42	30.71	18.05	18.05	1.00	1.45
733	2	25-Yr	733-Arch	288.00	95.00	49.00	51.51	51.51	52.47	0.014058	2.51	1.91	7.86	36.63	19.22	19.22	1.00	1.57
733	2	25-Yr	733-Ex	288.00	95.00	49.00	51.51	51.51	52.47	0.014059	2.51	1.91	7.86	36.63	19.22	19.22	1.00	1.57
733	2	50-Yr	733-Arch	334.00	95.00	49.00	51.73	51.73	52.76	0.013810	2.73	2.05	8.15	40.96	20.02	20.02	1.00	1.65
733	2	50-Yr	733-Ex	334.00	95.00	49.00	51.73	51.73	52.76	0.013809	2.73	2.05	8.15	40.96	20.02	20.02	1.00	1.65
733	2	100-Yr	733-Arch	381.00	95.00	49.00	51.93	51.93	53.04	0.013592	2.93	2.20	8.46	45.05	20.50	20.50	1.01	1.73
733	2	100-Yr	733-Ex	381.00	95.00	49.00	51.93	51.93	53.04	0.013589	2.93	2.20	8.46	45.06	20.50	20.50	1.01	1.73
733	5			Culvert														
733	10	5-cfs	733-Arch	5.00	228.00	50.47	51.08	51.08	51.23	0.029474	0.61	0.29	3.08	1.62	5.53	5.53	1.00	0.46
733	10	5-cfs	733-Ex	5.00	228.00	50.47	51.39	51.08	51.41	0.002940	0.92	0.47	1.32	3.78	8.05	8.05	0.34	0.07
733	10	25-cfs	733-Arch	25.00	228.00	50.47	51.59	51.59	51.91	0.024397	1.12	0.61	4.49	5.57	9.11	9.11	1.01	0.78
733	10	25-cfs	733-Ex	25.00	228.00	50.47	52.47	51.59	52.51	0.001198	2.00	1.43	1.74	15.02	12.41	9.81	0.26	0.09
733	10	Fish psg 0.4*Q2	733-Arch	50.00	228.00	50.47	51.96	51.96	52.43	0.021169	1.49	0.93	5.47	9.22	10.61	9.81	1.00	1.01
733	10	Fish psg 0.4*Q2	733-Ex	50.00	228.00	50.47	53.38	51.96	53.44	0.000815	2.91	2.35	1.99	28.01	16.25	9.81	0.23	0.10
733	10	100-cfs	733-Arch	100.00	228.00	50.47	52.52	52.52	53.20	0.016863	2.05	1.49	6.68	15.69	12.60	9.81	0.96	1.28
733	10	100-cfs	733-Ex	100.00	228.00	50.47	54.92	52.52	54.97	0.000460	4.45	3.89	2.09	58.42	22.44	9.81	0.19	0.09
733	10	2-Yr	733-Arch	125.00	228.00	50.47	52.76	52.76	53.51	0.015545	2.29	1.73	7.08	18.81	13.46	9.81	0.95	1.37
733	10	2-Yr	733-Ex	125.00	228.00	50.47	56.78	52.76	56.81	0.000153	6.31	5.74	1.56	101.33	23.14	9.81	0.11	0.04
733	10	5-Yr	733-Arch	186.00	228.00	50.47	53.25	53.25	54.17	0.014009	2.78	2.22	7.94	25.86	15.53	9.81	0.94	1.59
733	10	5-Yr	733-Ex	186.00	228.00	50.47	60.43	53.25	60.45	0.000058	9.96	9.40	1.34	185.98	23.14	9.81	0.08	0.03
733	10	10-Yr	733-Arch	228.00	228.00	50.47	53.56	53.56	54.55	0.012943	3.09	2.53	8.33	30.95	17.18	9.81	0.92	1.68
733	10	10-Yr	733-Ex	228.00	228.00	50.47	60.88	53.56	60.91	0.000075	10.41	9.85	1.57	196.37	23.14	9.81	0.09	0.04
733	10	25-Yr	733-Arch	288.00	228.00	50.47	54.58	53.96	55.20	0.005504	4.11	3.55	6.81	50.99	21.54	9.81	0.64	1.00
733	10	25-Yr	733-Ex	288.00	228.00	50.47	61.44	53.96	61.48	0.000099	10.97	10.40	1.87	209.19	23.14	9.81	0.10	0.05
733	10	50-Yr	733-Arch	334.00	228.00	50.47	55.23	54.24	55.74	0.003775	4.76	4.19	6.30	65.46	23.14	9.81	0.54	0.81
733	10	50-Yr	733-Ex	334.00	228.00	50.47	61.78	54.24	61.83	0.000119	11.31	10.75	2.10	217.11	23.14	9.81	0.11	0.07

HEC-RAS River: 733 Reach: 733 (Continued)

Reach	River Sta	Profile	Plan	Q Total (cfs)	Cum Ch Len (ft)	Min Ch El (ft)	W.S. Elev (ft)	Crit W.S. (ft)	E.G. Elev (ft)	E.G. Slope (ft/ft)	Max Chl Dpth (ft)	Hydr Depth C (ft)	Vel Chnl (ft/s)	Flow Area (sq ft)	Top Width (ft)	Top W Chnl (ft)	Froude # Chl	Shear Chan (lb/sq ft)
733	10	100-Yr	733-Arch	381.00	228.00	50.47	55.81	54.46	56.27	0.002895	5.34	4.78	6.02	78.99	23.14	9.81	0.49	0.71
733	10	100-Yr	733-Ex	381.00	228.00	50.47	62.07	54.46	62.13	0.000143	11.60	11.03	2.33	223.73	23.14	9.81	0.12	0.08
733	11	5-cfs	733-Arch	5.00	353.00	51.01	51.95	51.62	51.98	0.002492	0.94	0.49	1.25	4.01	8.19	8.19	0.31	0.06
733	11	5-cfs	733-Ex	5.00	353.00	51.01	51.84		51.88	0.005066	0.83	0.41	1.59	3.14	7.64	7.64	0.44	0.11
733	11	25-cfs	733-Arch	25.00	353.00	51.01	52.67	52.13	52.75	0.003008	1.66	1.10	2.30	11.06	11.21	9.81	0.39	0.17
733	11	25-cfs	733-Ex	25.00	353.00	51.01	52.67		52.75	0.003043	1.66	1.09	2.31	11.02	11.20	9.81	0.39	0.17
733	11	Fish psg 0.4*Q2	733-Arch	50.00	353.00	51.01	53.16	52.50	53.31	0.003328	2.15	1.59	3.10	17.01	12.97	9.81	0.43	0.27
733	11	Fish psg 0.4*Q2	733-Ex	50.00	353.00	51.01	53.50		53.59	0.001675	2.49	1.93	2.50	21.60	14.18	9.81	0.32	0.17
733	11	100-cfs	733-Arch	100.00	353.00	51.01	53.85	53.06	54.10	0.003680	2.84	2.28	4.14	26.78	15.84	9.81	0.48	0.43
733	11	100-cfs	733-Ex	100.00	353.00	51.01	54.97		55.06	0.000787	3.96	3.40	2.50	47.84	21.15	9.81	0.24	0.14
733	11	2-Yr	733-Arch	125.00	353.00	51.01	54.11	53.30	54.41	0.003809	3.10	2.54	4.54	31.20	17.26	9.81	0.50	0.50
733	11	2-Yr	733-Ex	125.00	353.00	51.01	56.79		56.83	0.000220	5.78	5.22	1.76	89.22	23.14	9.81	0.14	0.06
733	11	5-Yr	733-Arch	186.00	353.00	51.01	54.68	53.79	55.06	0.003898	3.67	3.11	5.25	41.79	20.13	9.81	0.52	0.62
733	11	5-Yr	733-Ex	186.00	353.00	51.01	60.44		60.46	0.000071	9.43	8.87	1.42	173.63	23.14	9.81	0.08	0.03
733	11	10-Yr	733-Arch	228.00	353.00	51.01	55.00	54.10	55.43	0.003954	3.99	3.43	5.64	48.46	21.23	9.81	0.54	0.69
733	11	10-Yr	733-Ex	228.00	353.00	51.01	60.89		60.92	0.000090	9.88	9.32	1.66	184.05	23.14	9.81	0.10	0.04
733	11	25-Yr	733-Arch	288.00	353.00	51.01	55.29		55.83	0.004549	4.28	3.72	6.39	54.73	22.00	9.81	0.58	0.87
733	11	25-Yr	733-Ex	288.00	353.00	51.01	61.45		61.49	0.000118	10.44	9.87	1.97	196.93	23.14	9.81	0.11	0.06
733	11	50-Yr	733-Arch	334.00	353.00	51.01	55.70		56.23	0.004045	4.69	4.12	6.45	63.84	23.08	9.81	0.56	0.85
733	11	50-Yr	733-Ex	334.00	353.00	51.01	61.79		61.85	0.000141	10.78	10.22	2.21	204.90	23.14	9.81	0.12	0.07
733	11	100-Yr	733-Arch	381.00	353.00	51.01	56.16		56.67	0.003397	5.15	4.59	6.35	74.66	23.14	9.81	0.52	0.80
733	11	100-Yr	733-Ex	381.00	353.00	51.01	62.08		62.15	0.000168	11.07	10.51	2.45	211.58	23.14	9.81	0.13	0.09

Tributary 865+88 HEC-RAS

Companion 2006 Stream and Habitat Inventory (S&HI) station 886+00
Model based on ADOT&PF project datum

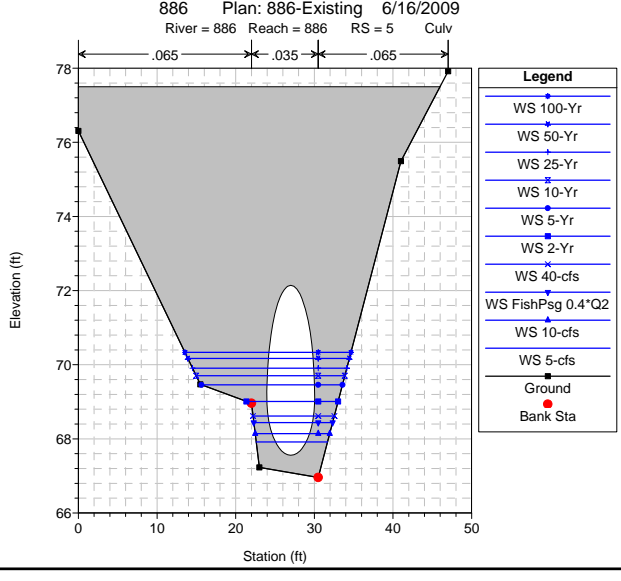
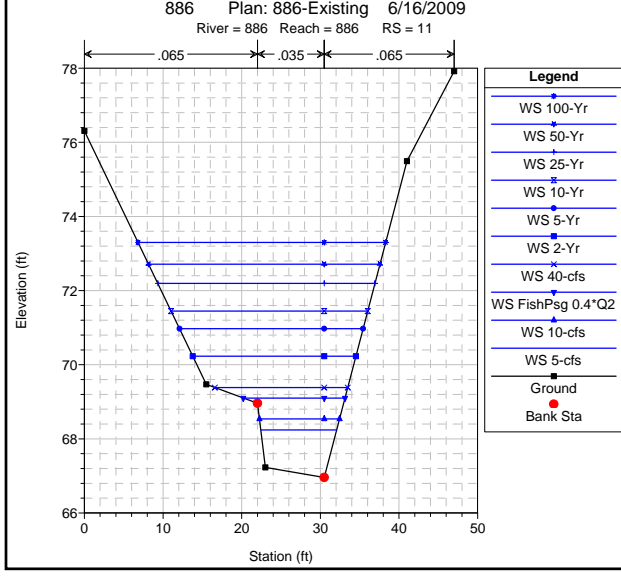
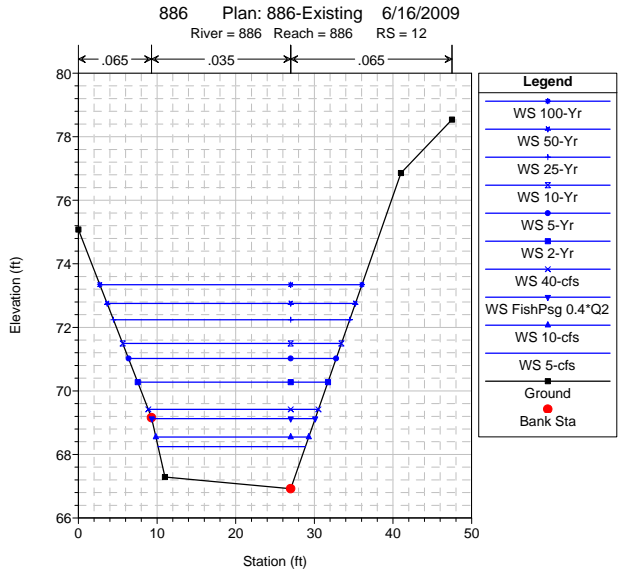
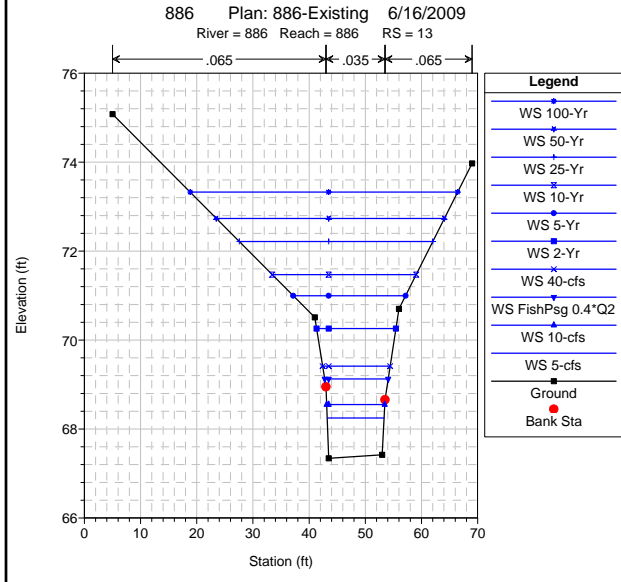
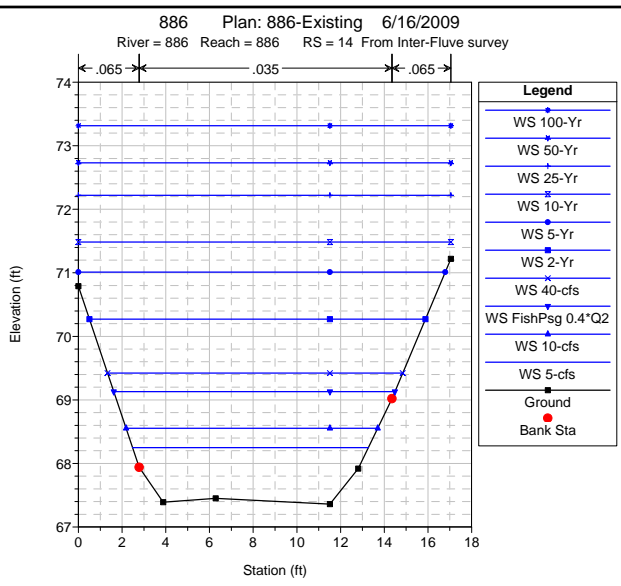
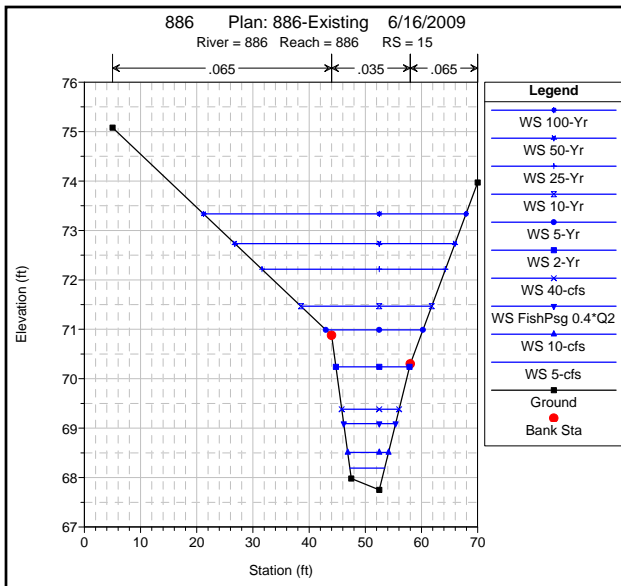

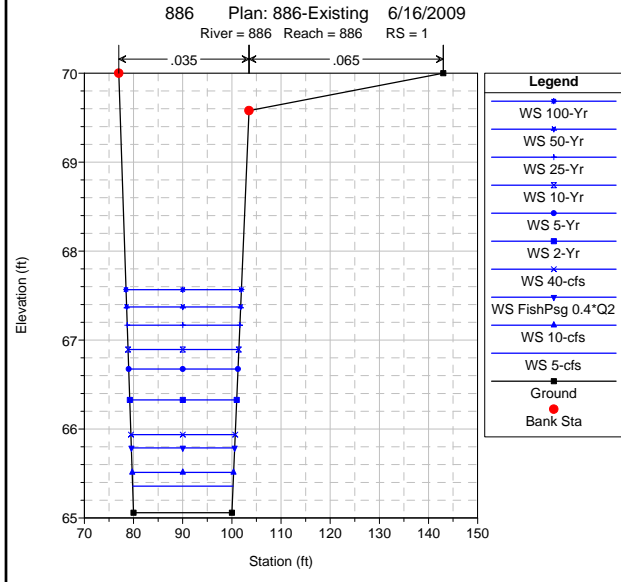
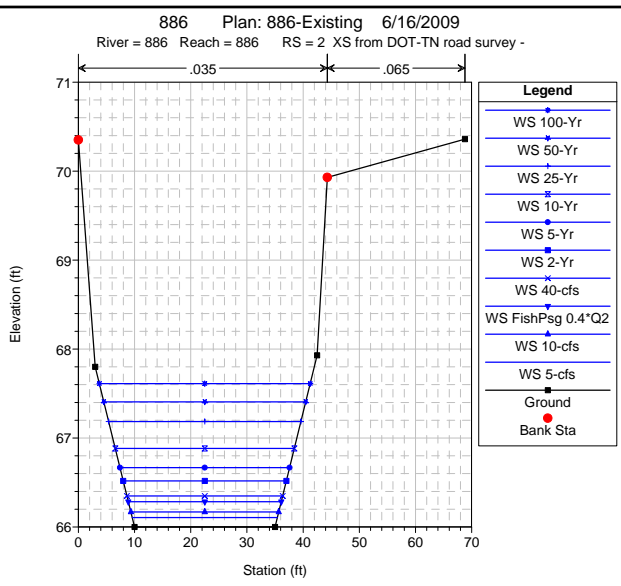
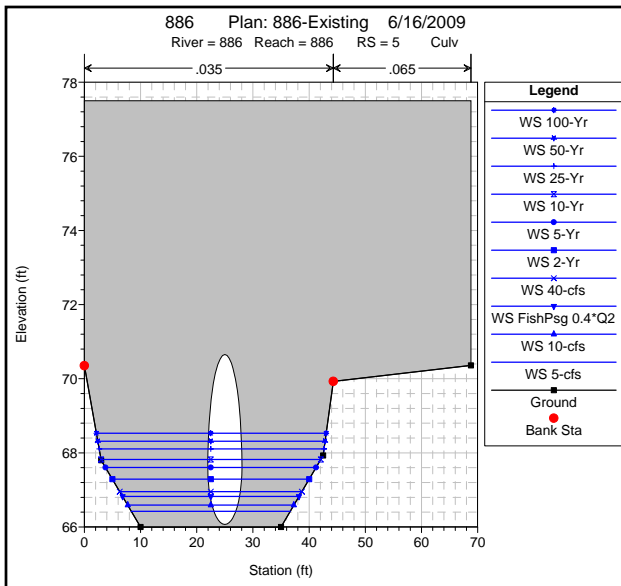

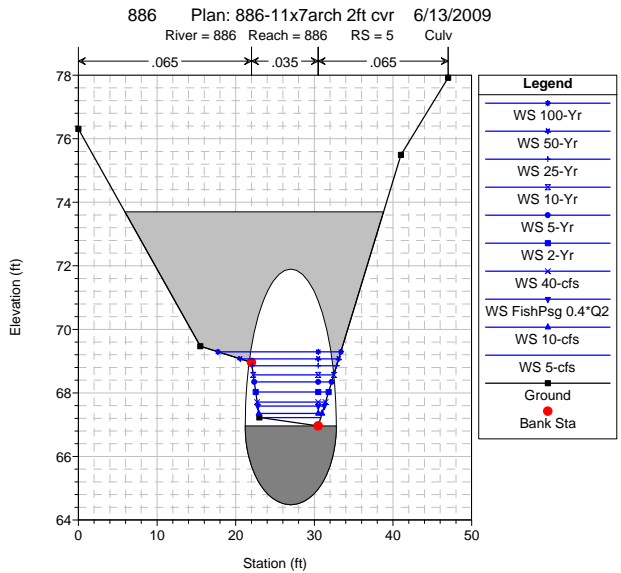
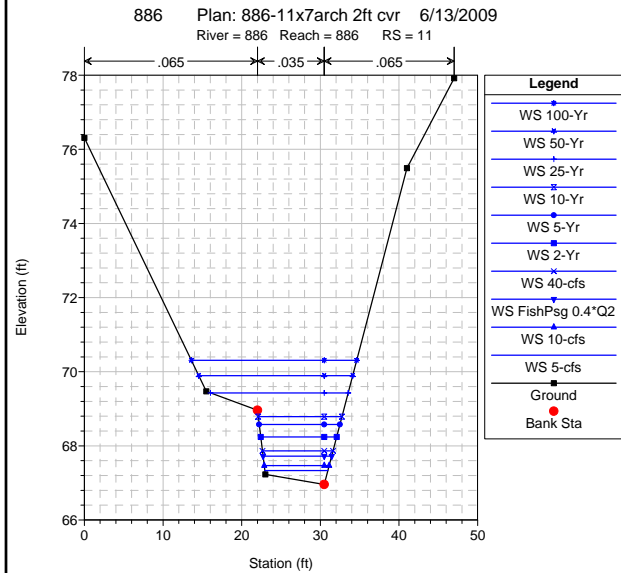
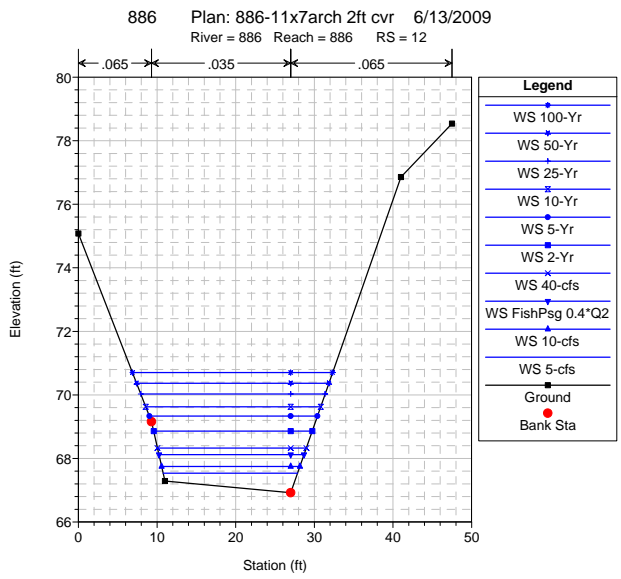
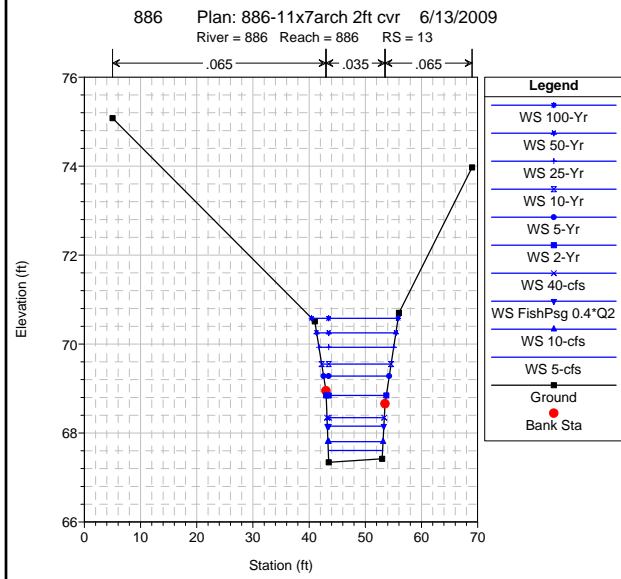
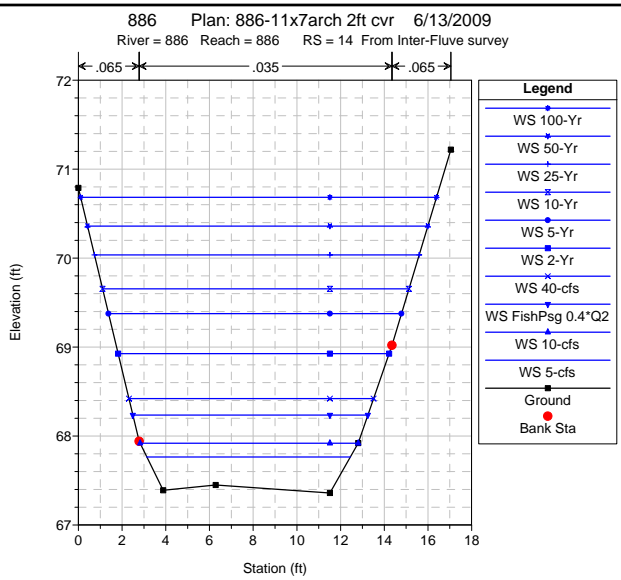
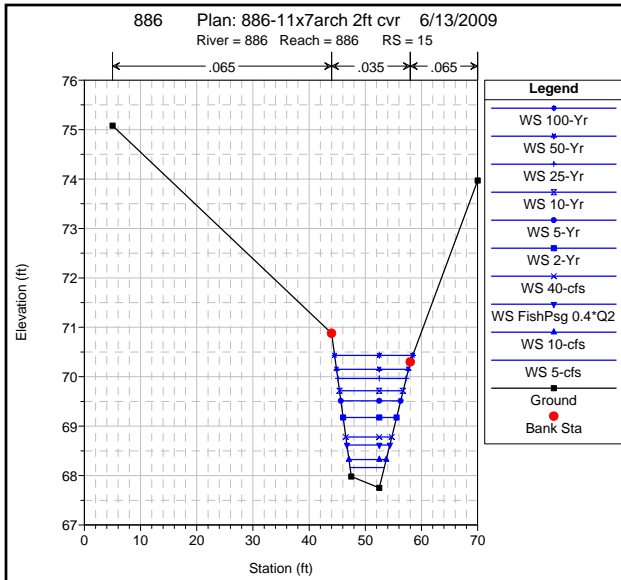

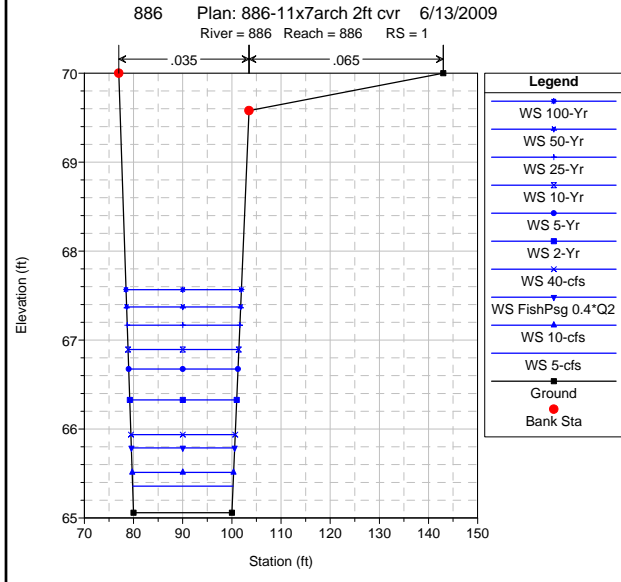
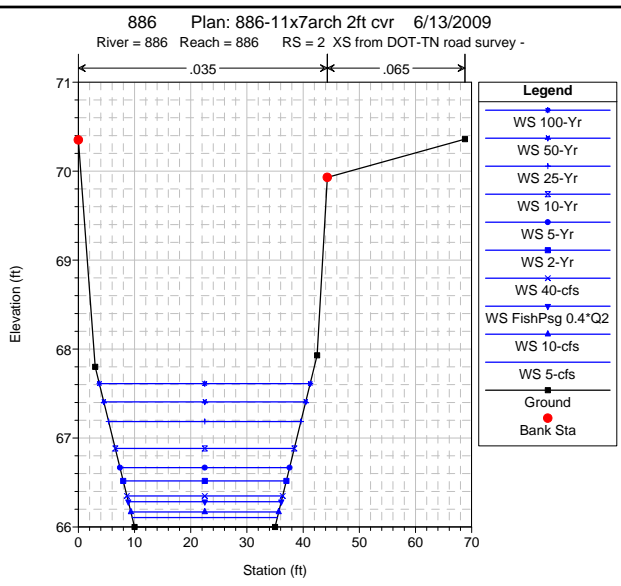
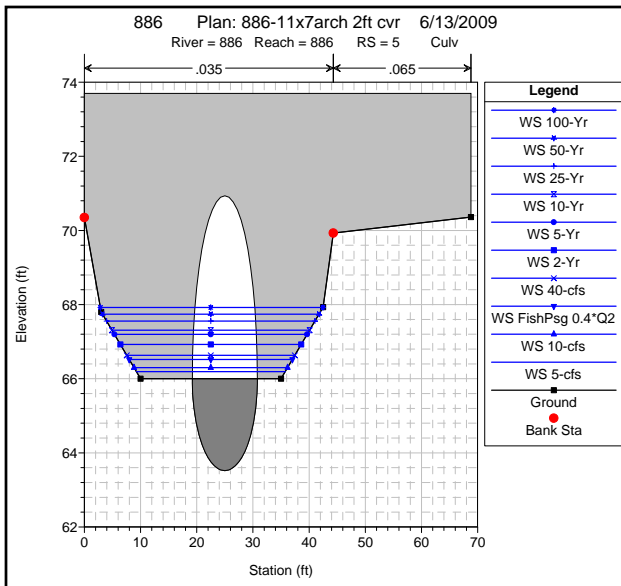

HEC-RAS River: 886 Reach: 886

Reach	River Sta	Profile	Plan	Q Total (cfs)	Cum Ch Len (ft)	Min Ch El (ft)	W.S. Elev (ft)	Crit W.S. (ft)	E.G. Elev (ft)	E.G. Slope (ft/ft)	Max Chl Dpth (ft)	Hydr Depth C (ft)	Vel Chnl (ft/s)	Flow Area (sq ft)	Top Width (ft)	Top W Chnl (ft)	Froude # Chl	Shear Chan (lb/sq ft)
886	1	5-cfs	886-11x7cvr	5.00		65.06	65.36	65.18	65.37	0.002001	0.30	0.29	0.83	6.01	20.41	20.41	0.27	0.04
886	1	5-cfs	886-Ex	5.00		65.06	65.36	65.18	65.37	0.002001	0.30	0.29	0.83	6.01	20.41	20.41	0.27	0.04
886	1	10-cfs	886-11x7cvr	10.00		65.06	65.51	65.26	65.53	0.002000	0.45	0.44	1.09	9.18	20.62	20.62	0.29	0.05
886	1	10-cfs	886-Ex	10.00		65.06	65.51	65.26	65.53	0.002000	0.45	0.44	1.09	9.18	20.62	20.62	0.29	0.05
886	1	FishPsg 0.4*Q2	886-11x7cvr	22.00		65.06	65.79	65.39	65.82	0.002002	0.73	0.71	1.48	14.91	21.00	21.00	0.31	0.09
886	1	FishPsg 0.4*Q2	886-Ex	22.00		65.06	65.79	65.39	65.82	0.002002	0.73	0.71	1.48	14.91	21.00	21.00	0.31	0.09
886	1	40-cfs	886-11x7cvr	30.00		65.06	65.94	65.47	65.98	0.002000	0.88	0.85	1.66	18.08	21.21	21.21	0.32	0.10
886	1	40-cfs	886-Ex	30.00		65.06	65.94	65.47	65.98	0.002000	0.88	0.85	1.66	18.08	21.21	21.21	0.32	0.10
886	1	2-Yr	886-11x7cvr	55.00		65.06	66.33	65.67	66.39	0.002001	1.27	1.22	2.08	26.45	21.75	21.75	0.33	0.14
886	1	2-Yr	886-Ex	55.00		65.06	66.33	65.67	66.39	0.002001	1.27	1.22	2.08	26.45	21.75	21.75	0.33	0.14
886	1	5-Yr	886-11x7cvr	82.00		65.06	66.68	65.86	66.76	0.002000	1.62	1.53	2.40	34.10	22.23	22.23	0.34	0.18
886	1	5-Yr	886-Ex	82.00		65.06	66.68	65.85	66.76	0.002000	1.62	1.53	2.40	34.10	22.23	22.23	0.34	0.18
886	1	10-Yr	886-11x7cvr	101.00		65.06	66.89	65.97	67.00	0.002001	1.83	1.73	2.59	38.98	22.53	22.53	0.35	0.20
886	1	10-Yr	886-Ex	101.00		65.06	66.89	65.97	67.00	0.002001	1.83	1.73	2.59	38.98	22.53	22.53	0.35	0.20
886	1	25-Yr	886-11x7cvr	127.00		65.06	67.17	66.12	67.29	0.002003	2.11	1.97	2.81	45.19	22.91	22.91	0.35	0.22
886	1	25-Yr	886-Ex	127.00		65.06	67.17	66.12	67.29	0.002003	2.11	1.97	2.81	45.19	22.91	22.91	0.35	0.22
886	1	50-Yr	886-11x7cvr	148.00		65.06	67.37	66.23	67.51	0.002000	2.31	2.15	2.96	49.95	23.20	23.20	0.36	0.24
886	1	50-Yr	886-Ex	148.00		65.06	67.37	66.23	67.51	0.002000	2.31	2.15	2.96	49.95	23.20	23.20	0.36	0.24
886	1	100-Yr	886-11x7cvr	169.00		65.06	67.57	66.34	67.72	0.002001	2.51	2.32	3.10	54.48	23.46	23.46	0.36	0.26
886	1	100-Yr	886-Ex	169.00		65.06	67.57	66.34	67.72	0.002001	2.51	2.32	3.10	54.48	23.46	23.46	0.36	0.26
886	2	5-cfs	886-11x7cvr	5.00	22.00	66.00	66.11	66.11	66.16	0.039151	0.11	0.10	1.86	2.69	25.82	25.82	1.01	0.25
886	2	5-cfs	886-Ex	5.00	22.00	66.00	66.11	66.11	66.16	0.039151	0.11	0.10	1.86	2.69	25.82	25.82	1.01	0.25
886	2	10-cfs	886-11x7cvr	10.00	22.00	66.00	66.17	66.17	66.25	0.032688	0.17	0.16	2.31	4.34	26.31	26.31	1.00	0.34
886	2	10-cfs	886-Ex	10.00	22.00	66.00	66.17	66.17	66.25	0.032688	0.17	0.16	2.31	4.34	26.31	26.31	1.00	0.34
886	2	FishPsg 0.4*Q2	886-11x7cvr	22.00	22.00	66.00	66.28	66.28	66.42	0.027783	0.28	0.27	2.97	7.41	27.21	27.21	1.00	0.47
886	2	FishPsg 0.4*Q2	886-Ex	22.00	22.00	66.00	66.28	66.28	66.42	0.027783	0.28	0.27	2.97	7.41	27.21	27.21	1.00	0.47
886	2	40-cfs	886-11x7cvr	30.00	22.00	66.00	66.35	66.35	66.51	0.025798	0.35	0.33	3.26	9.20	27.71	27.71	1.00	0.53
886	2	40-cfs	886-Ex	30.00	22.00	66.00	66.35	66.35	66.51	0.025798	0.35	0.33	3.26	9.20	27.71	27.71	1.00	0.53
886	2	2-Yr	886-11x7cvr	55.00	22.00	66.00	66.52	66.52	66.76	0.022852	0.52	0.48	3.93	13.99	29.03	29.03	1.00	0.68
886	2	2-Yr	886-Ex	55.00	22.00	66.00	66.52	66.52	66.76	0.022852	0.52	0.48	3.93	13.99	29.03	29.03	1.00	0.68
886	2	5-Yr	886-11x7cvr	82.00	22.00	66.00	66.67	66.67	66.98	0.021462	0.67	0.61	4.46	18.40	30.19	30.19	1.01	0.81
886	2	5-Yr	886-Ex	82.00	22.00	66.00	66.67	66.67	66.98	0.021462	0.67	0.61	4.46	18.40	30.19	30.19	1.01	0.81
886	2	10-Yr	886-11x7cvr	101.00	22.00	66.00	66.88	66.88	67.13	0.012450	0.88	0.79	4.02	25.11	31.87	31.87	0.80	0.61
886	2	10-Yr	886-Ex	101.00	22.00	66.00	66.88	66.88	67.13	0.012450	0.88	0.79	4.02	25.11	31.87	31.87	0.80	0.61
886	2	25-Yr	886-11x7cvr	127.00	22.00	66.00	67.19	67.19	67.39	0.007096	1.19	1.03	3.62	35.11	34.22	34.22	0.63	0.45
886	2	25-Yr	886-Ex	127.00	22.00	66.00	67.19	67.19	67.39	0.007096	1.19	1.03	3.62	35.11	34.22	34.22	0.63	0.45
886	2	50-Yr	886-11x7cvr	148.00	22.00	66.00	67.41	67.41	67.59	0.005304	1.41	1.19	3.45	42.85	35.93	35.93	0.56	0.39
886	2	50-Yr	886-Ex	148.00	22.00	66.00	67.41	67.41	67.59	0.005304	1.41	1.19	3.45	42.85	35.93	35.93	0.56	0.39
886	2	100-Yr	886-11x7cvr	169.00	22.00	66.00	67.61	67.61	67.79	0.004277	1.61	1.34	3.35	50.38	37.53	37.53	0.51	0.35
886	2	100-Yr	886-Ex	169.00	22.00	66.00	67.61	67.61	67.79	0.004277	1.61	1.34	3.35	50.38	37.53	37.53	0.51	0.35
886	5			Culvert														
886	11	5-cfs	886-11x7cvr	5.00	142.00	66.96	67.33	67.33	67.45	0.029368	0.37	0.24	2.76	1.86	8.02	7.56	1.00	0.43
886	11	5-cfs	886-Ex	5.00	142.00	66.96	68.24	67.33	68.25	0.000158	1.28	1.10	0.54	9.90	9.66	8.08	0.09	0.01
886	11	10-cfs	886-11x7cvr	10.00	142.00	66.96	67.47	67.47	67.65	0.026309	0.51	0.37	3.49	2.97	8.26	7.64	1.01	0.59
886	11	10-cfs	886-Ex	10.00	142.00	66.96	68.54	67.47	68.55	0.000293	1.58	1.37	0.85	12.84	10.20	8.26	0.13	0.02
886	11	FishPsg 0.4*Q2	886-11x7cvr	22.00	142.00	66.96	67.72	67.72	68.03	0.022368	0.76	0.61	4.48	5.15	8.73	7.79	1.01	0.83
886	11	FishPsg 0.4*Q2	886-Ex	22.00	142.00	66.96	69.10	67.72	69.13	0.000462	2.14	1.89	1.29	19.00	12.93	8.50	0.17	0.05
886	11	40-cfs	886-11x7cvr	30.00	142.00	66.96	67.87	67.87	68.24	0.021209	0.91	0.75	4.95	6.40	8.98	7.87	1.01	0.95
886	11	40-cfs	886-Ex	30.00	142.00	66.96	69.39	67.87	69.42	0.000525	2.43	2.17	1.51	23.24	16.91	8.50	0.18	0.06
886	11	2-Yr	886-11x7cvr	55.00	142.00	66.96	68.24	68.24	68.77	0.019210	1.28	1.10	5.97	9.88	9.66	8.08	1.01	1.23
886	11	2-Yr	886-Ex	55.00	142.00	66.96	70.23	68.24	70.28	0.000509	3.27	3.02	1.86	39.49	20.75	8.50	0.19	0.09
886	11	5-Yr	886-11x7cvr	82.00	142.00	66.96	68.58	68.58	69.25	0.018081	1.62	1.40	6.74	13.23	10.27	8.28	1.00	1.45
886	11	5-Yr	886-Ex	82.00	142.00	66.96	70.97	68.58	71.03	0.000481	4.01	3.76	2.09	55.80	23.34	8.50	0.19	0.10
886	11	10-Yr	886-11x7cvr	101.00	142.00	66.96	68.79	68.79	69.55	0.017541	1.83	1.59	7.17	15.45	10.65	8.40	1.00	1.58
886	11	10-Yr	886-Ex	101.00	142.00	66.96	71.45	68.79	71.51	0.000456	4.49	4.23	2.20	67.30	25.00	8.50	0.19	0.11
886	11	25-Yr	886-11x7cvr	127.00	142.00	66.96	69.43	69.05	70.00	0.008752	2.47	2.22	6.27	23.99	17.51	8.50	0.74	1.08
886	11	25-Yr	886-Ex	127.00	142.00	66.96	72.19	69.05	72.25	0.000379	5.23	4.98	2.24	86.96	27.61	8.50	0.18	0.11
886	11	50-Yr	886-11x7cvr	148.00	142.00	66.96	69.90	69.28	70.37	0.005801	2.94	2.68	5.80	32.73	19.58	8.50	0.62	0.87
886	11	50-Yr	886-Ex	148.00	142.00	66.96	72.71	69.28	72.77	0.000347	5.75	5.50	2.29	101.70	29.42	8.50	0.17	0.11
886	11	100-Yr	886-11x7cvr	169.00	142.00	66.96	70.31	69.53	70.72	0.004356	3.35	3.10	5.52	41.11	21.02	8.50	0.55	0.75
886	11	100-Yr	886-Ex	169.00	142.00	66.96	73.30	69.53	73.36	0.000301	6.34	6.09	2.28	119.69	31.49	8.50	0.16	0.10

HEC-RAS River: 886 Reach: 886 (Continued)

Reach	River Sta	Profile	Plan	Q Total (cfs)	Cum Ch Len (ft)	Min Ch El (ft)	W.S. Elev (ft)	Crit W.S. (ft)	E.G. Elev (ft)	E.G. Slope (ft/ft)	Max Chl Dpth (ft)	Hydr Depth C (ft)	Vel Chnl (ft/s)	Flow Area (sq ft)	Top Width (ft)	Top W Chnl (ft)	Froude # Chl	Shear Chan (lb/sq ft)
886	12	5-cfs	886-11x7cvr	5.00	175.00	66.92	67.53		67.54	0.000894	0.61	0.43	0.71	7.16	17.09	16.22	0.19	0.02
886	12	5-cfs	886-Ex	5.00	175.00	66.92	68.25		68.25	0.000334	1.33	1.11	0.26	19.93	18.74	16.87	0.04	0.00
886	12	10-cfs	886-11x7cvr	10.00	175.00	66.92	67.75		67.76	0.000942	0.83	0.63	0.95	10.83	17.58	16.41	0.21	0.04
886	12	10-cfs	886-Ex	10.00	175.00	66.92	68.55		68.55	0.000062	1.63	1.39	0.41	25.72	19.44	17.15	0.06	0.01
886	12	FishPsg 0.4*Q2	886-11x7cvr	22.00	175.00	66.92	68.12		68.15	0.000984	1.20	0.99	1.30	17.56	18.44	16.75	0.23	0.06
886	12	FishPsg 0.4*Q2	886-Ex	22.00	175.00	66.92	69.13		69.13	0.000097	2.21	1.92	0.63	37.33	20.78	17.67	0.08	0.01
886	12	40-cfs	886-11x7cvr	30.00	175.00	66.92	68.33		68.36	0.000988	1.41	1.18	1.46	21.41	18.92	16.94	0.24	0.07
886	12	40-cfs	886-Ex	30.00	175.00	66.92	69.42		69.43	0.000112	2.50	2.21	0.74	43.53	21.63	17.70	0.09	0.01
886	12	2-Yr	886-11x7cvr	55.00	175.00	66.92	68.86		68.91	0.000983	1.94	1.67	1.83	31.84	20.16	17.43	0.25	0.10
886	12	2-Yr	886-Ex	55.00	175.00	66.92	70.27		70.29	0.000124	3.35	3.06	0.97	63.08	24.17	17.70	0.10	0.02
886	12	5-Yr	886-11x7cvr	82.00	175.00	66.92	69.33		69.40	0.000964	2.41	2.12	2.11	41.63	21.37	17.70	0.26	0.12
886	12	5-Yr	886-Ex	82.00	175.00	66.92	71.02		71.04	0.000130	4.10	3.81	1.14	81.91	26.39	17.70	0.10	0.03
886	12	10-Yr	886-11x7cvr	101.00	175.00	66.92	69.62		69.70	0.000944	2.70	2.41	2.27	48.01	22.24	17.70	0.26	0.14
886	12	10-Yr	886-Ex	101.00	175.00	66.92	71.50		71.52	0.000131	4.58	4.28	1.24	94.84	27.81	17.70	0.11	0.03
886	12	25-Yr	886-11x7cvr	127.00	175.00	66.92	70.03		70.12	0.000882	3.11	2.81	2.44	57.20	23.44	17.70	0.26	0.15
886	12	25-Yr	886-Ex	127.00	175.00	66.92	72.24		72.26	0.000118	5.32	5.03	1.31	116.34	30.03	17.70	0.10	0.04
886	12	50-Yr	886-11x7cvr	148.00	175.00	66.92	70.37		70.46	0.000811	3.45	3.15	2.52	65.31	24.45	17.70	0.25	0.15
886	12	50-Yr	886-Ex	148.00	175.00	66.92	72.75		72.78	0.000113	5.83	5.54	1.37	132.20	31.56	17.70	0.10	0.04
886	12	100-Yr	886-11x7cvr	169.00	175.00	66.92	70.70		70.80	0.000745	3.78	3.49	2.59	73.73	25.45	17.70	0.24	0.15
886	12	100-Yr	886-Ex	169.00	175.00	66.92	73.34		73.37	0.000103	6.42	6.13	1.40	151.24	33.31	17.70	0.10	0.04
886	13	5-cfs	886-11x7cvr	5.00	225.00	67.34	67.61		67.69	0.021920	0.27	0.23	2.28	2.19	9.66	9.66	0.85	0.30
886	13	5-cfs	886-Ex	5.00	225.00	67.34	68.25		68.25	0.000281	0.91	0.84	0.59	8.51	10.12	10.12	0.11	0.01
886	13	10-cfs	886-11x7cvr	10.00	225.00	67.34	67.81		67.90	0.011385	0.47	0.42	2.44	4.10	9.80	9.80	0.66	0.28
886	13	10-cfs	886-Ex	10.00	225.00	67.34	68.55		68.56	0.000430	1.21	1.12	0.86	11.61	10.33	10.33	0.14	0.03
886	13	FishPsg 0.4*Q2	886-11x7cvr	22.00	225.00	67.34	68.15		68.29	0.007869	0.81	0.75	2.91	7.56	10.05	10.05	0.59	0.33
886	13	FishPsg 0.4*Q2	886-Ex	22.00	225.00	67.34	69.12		69.15	0.000549	1.78	1.68	1.25	17.76	11.29	10.50	0.17	0.05
886	13	40-cfs	886-11x7cvr	30.00	225.00	67.34	68.35		68.50	0.007173	1.01	0.93	3.16	9.50	10.19	10.19	0.58	0.37
886	13	40-cfs	886-Ex	30.00	225.00	67.34	69.45		69.45	0.000597	2.07	1.97	1.45	21.13	12.02	10.50	0.18	0.06
886	13	2-Yr	886-11x7cvr	55.00	225.00	67.34	68.84		69.06	0.006245	1.50	1.40	3.75	14.69	10.69	10.47	0.56	0.46
886	13	2-Yr	886-Ex	55.00	225.00	67.34	70.26		70.31	0.000591	2.82	2.81	1.83	32.19	14.14	10.50	0.19	0.09
886	13	5-Yr	886-11x7cvr	82.00	225.00	67.34	69.28		69.56	0.005644	1.94	1.83	4.25	19.56	11.69	10.50	0.55	0.54
886	13	5-Yr	886-Ex	82.00	225.00	67.34	71.00		71.06	0.000584	3.66	3.55	2.12	44.20	20.02	10.50	0.20	0.11
886	13	10-Yr	886-11x7cvr	101.00	225.00	67.34	69.55		69.87	0.005389	2.21	2.10	4.55	22.80	12.36	10.50	0.55	0.59
886	13	10-Yr	886-Ex	101.00	225.00	67.34	71.47		71.55	0.000556	4.13	4.02	2.25	55.03	25.64	10.50	0.20	0.12
886	13	25-Yr	886-11x7cvr	127.00	225.00	67.34	69.93		70.28	0.004854	2.59	2.48	4.82	27.64	13.31	10.50	0.54	0.63
886	13	25-Yr	886-Ex	127.00	225.00	67.34	72.22		72.29	0.000446	4.88	4.77	2.26	77.44	34.48	10.50	0.18	0.11
886	13	50-Yr	886-11x7cvr	148.00	225.00	67.34	70.25		70.62	0.004315	2.91	2.80	4.93	32.09	14.12	10.50	0.52	0.63
886	13	50-Yr	886-Ex	148.00	225.00	67.34	72.73		72.80	0.000391	5.39	5.29	2.26	96.88	40.61	10.50	0.17	0.11
886	13	100-Yr	886-11x7cvr	169.00	225.00	67.34	70.58		70.96	0.003844	3.24	3.13	5.01	36.86	15.40	10.50	0.50	0.63
886	13	100-Yr	886-Ex	169.00	225.00	67.34	73.33		73.39	0.000317	5.99	5.88	2.19	122.99	47.63	10.50	0.16	0.10
886	14	5-cfs	886-11x7cvr	5.00	235.00	67.36	67.77	67.64	67.81	0.006837	0.41	0.33	1.64	3.04	9.32	9.32	0.51	0.14
886	14	5-cfs	886-Ex	5.00	235.00	67.36	68.25		68.26	0.000335	0.89	0.76	0.63	7.97	10.79	10.49	0.13	0.02
886	14	10-cfs	886-11x7cvr	10.00	235.00	67.36	67.92		67.99	0.008062	0.56	0.45	2.21	4.52	9.98	9.98	0.58	0.22
886	14	10-cfs	886-Ex	10.00	235.00	67.36	68.55		68.57	0.000451	1.19	1.02	0.89	11.37	11.52	10.92	0.16	0.03
886	14	FishPsg 0.4*Q2	886-11x7cvr	22.00	235.00	67.36	68.23		68.36	0.006916	0.87	0.74	2.83	7.81	10.76	10.47	0.58	0.31
886	14	FishPsg 0.4*Q2	886-Ex	22.00	235.00	67.36	69.13		69.15	0.000510	1.77	1.53	1.23	18.40	12.87	11.57	0.18	0.05
886	14	40-cfs	886-11x7cvr	30.00	235.00	67.36	68.42		68.57	0.006268	1.06	0.91	3.07	9.85	11.20	10.73	0.57	0.34
886	14	40-cfs	886-Ex	30.00	235.00	67.36	69.42		69.45	0.000527	2.06	1.82	1.41	22.24	13.51	11.57	0.18	0.06
886	14	2-Yr	886-11x7cvr	55.00	235.00	67.36	68.93		69.12	0.005084	1.57	1.34	3.56	15.80	12.40	11.44	0.54	0.41
886	14	2-Yr	886-Ex	55.00	235.00	67.36	70.27		70.32	0.000481	2.91	2.67	1.73	34.51	15.38	11.57	0.19	0.08
886	14	5-Yr	886-11x7cvr	82.00	235.00	67.36	69.38		69.61	0.004302	2.02	1.77	3.95	21.61	13.41	11.57	0.52	0.45
886	14	5-Yr	886-Ex	82.00	235.00	67.36	71.01		71.07	0.000459	3.65	3.41	1.99	46.47	16.79	11.57	0.19	0.09
886	14	10-Yr	886-11x7cvr	101.00	235.00	67.36	69.65		69.92	0.003982	2.29	2.05	4.18	25.43	14.02	11.57	0.51	0.49
886	14	10-Yr	886-Ex	101.00	235.00	67.36	71.48		71.55	0.000444	4.12	3.88	2.14	54.50	17.05	11.57	0.19	0.10
886	14	25-Yr	886-11x7cvr	127.00	235.00	67.36	70.04		70.33	0.003516	2.68	2.44	4.41	30.96	14.86	11.57	0.50	0.51
886	14	25-Yr	886-Ex	127.00	235.00	67.36	72.22		72.29	0.000385	4.86	4.62	2.24	67.04	17.05	11.57	0.18	0.11
886	14	50-Yr	886-11x7cvr	148.00	235.00	67.36	70.36		70.67	0.003115	3.00	2.76	4.51	35.87	15.57	11.57	0.48	0.51
886	14	50-Yr	886-Ex	148.00	235.00	67.36	72.73		72.81	0.000366	5.37	5.13	2.33	75.75	17.05	11.57	0.18	0.11
886	14	100-Yr	886-11x7cvr	169.00	235.00	67.36	70.68		71.00	0.002767	3.32	3.08	4.57	41.05	16.29	11.57	0.46	0.51
886	14	100-Yr	886-Ex	169.00	235.00	67.36	73.31		73.40	0.000331	5.95	5.71	2.39	85.70	17.05	11.57	0.18	0.11
886	15	5-cfs	886-11x7cvr	5.00	245.00	67.75	68.16	68.16	68.30	0.028205	0.41	0.28	2.97	1.68	6.11	6.11	1.00	0.47
886	15	5-cfs	886-Ex	5.00	245.00	67.75	68.19		68.30	0.020408	0.44	0.30	2.67	1.87	6.21	6.21	0.86	0.37

HEC-RAS River: 886 Reach: 886 (Continued)

Reach	River Sta	Profile	Plan	Q Total (cfs)	Cum Ch Len (ft)	Min Ch El (ft)	W.S. Elev (ft)	Crit W.S. (ft)	E.G. Elev (ft)	E.G. Slope (ft/ft)	Max Chl Dpth (ft)	Hydr Depth C (ft)	Vel Chnl (ft/s)	Flow Area (sq ft)	Top Width (ft)	Top W Chnl (ft)	Froude # Chl	Shear Chan (lb/sq ft)
886	15	10-cfs	886-11x7cvr	10.00	245.00	67.75	68.32	68.32	68.53	0.025769	0.57	0.41	3.67	2.73	6.66	6.66	1.01	0.63
886	15	10-cfs	886-Ex	10.00	245.00	67.75	68.51	68.60	68.60	0.008219	0.76	0.55	2.50	4.00	7.27	7.27	0.59	0.27
886	15	FishPsg 0.4*Q2	886-11x7cvr	22.00	245.00	67.75	68.62	68.62	68.94	0.022745	0.87	0.63	4.55	4.84	7.65	7.65	1.01	0.85
886	15	FishPsg 0.4*Q2	886-Ex	22.00	245.00	67.75	69.09	69.19	69.19	0.004044	1.34	0.96	2.49	8.82	9.24	9.24	0.45	0.22
886	15	40-cfs	886-11x7cvr	30.00	245.00	67.75	68.78	68.78	69.15	0.021587	1.03	0.75	4.92	6.10	8.18	8.18	1.00	0.94
886	15	40-cfs	886-Ex	30.00	245.00	67.75	69.38	69.49	69.49	0.003442	1.63	1.14	2.57	11.65	10.21	10.21	0.42	0.23
886	15	2-Yr	886-11x7cvr	55.00	245.00	67.75	69.17	69.17	69.68	0.019914	1.42	1.01	5.73	9.60	9.52	9.52	1.01	1.16
886	15	2-Yr	886-Ex	55.00	245.00	67.75	70.24	70.34	70.34	0.002087	2.49	1.65	2.54	21.67	13.10	13.10	0.35	0.20
886	15	5-Yr	886-11x7cvr	82.00	245.00	67.75	69.51	69.51	70.13	0.018987	1.76	1.22	6.31	12.99	10.65	10.65	1.01	1.33
886	15	5-Yr	886-Ex	82.00	245.00	67.75	70.99	71.09	71.09	0.001405	3.24	2.28	2.56	32.72	17.27	14.00	0.30	0.18
886	15	10-Yr	886-11x7cvr	101.00	245.00	67.75	69.72	69.72	70.40	0.018535	1.97	1.34	6.63	15.23	11.33	11.33	1.01	1.42
886	15	10-Yr	886-Ex	101.00	245.00	67.75	71.47	71.57	71.57	0.001102	3.72	2.75	2.58	42.39	23.26	14.00	0.27	0.17
886	15	25-Yr	886-11x7cvr	127.00	245.00	67.75	69.96	69.96	70.72	0.018044	2.21	1.49	6.99	18.16	12.17	12.17	1.01	1.53
886	15	25-Yr	886-Ex	127.00	245.00	67.75	72.21	72.30	72.30	0.000719	4.46	3.50	2.44	63.30	32.65	14.00	0.23	0.14
886	15	50-Yr	886-11x7cvr	148.00	245.00	67.75	70.15	70.15	70.96	0.017652	2.40	1.60	7.23	20.47	12.79	12.79	1.01	1.60
886	15	50-Yr	886-Ex	148.00	245.00	67.75	72.73	72.81	72.81	0.000567	4.98	4.02	2.38	81.98	39.18	14.00	0.21	0.13
886	15	100-Yr	886-11x7cvr	169.00	245.00	67.75	70.43	70.32	71.19	0.014188	2.68	1.80	6.98	24.23	13.89	13.46	0.92	1.44
886	15	100-Yr	886-Ex	169.00	245.00	67.75	73.33	73.40	73.40	0.000419	5.58	4.62	2.24	107.74	46.71	14.00	0.18	0.11

Tributary 887+60 HEC-RAS

Companion 2006 Stream and Habitat Inventory (S&HI) station 917+00
Model based on ADOT&PF project datum

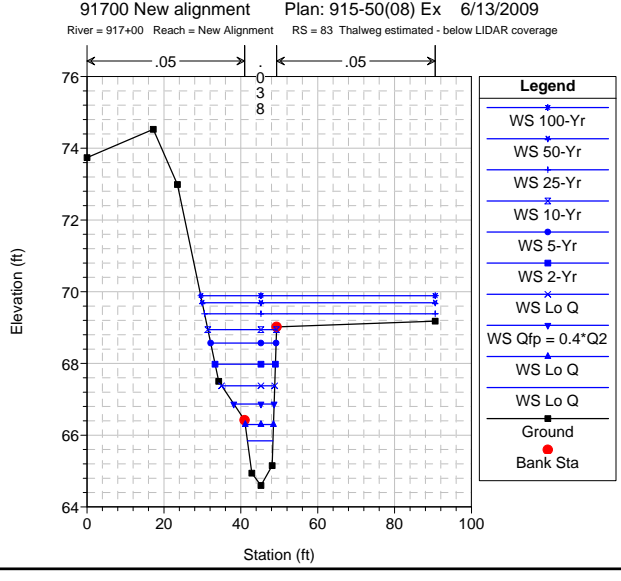
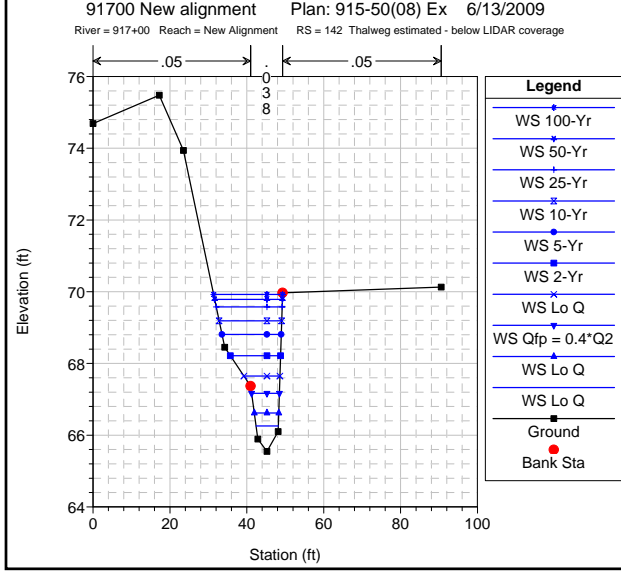
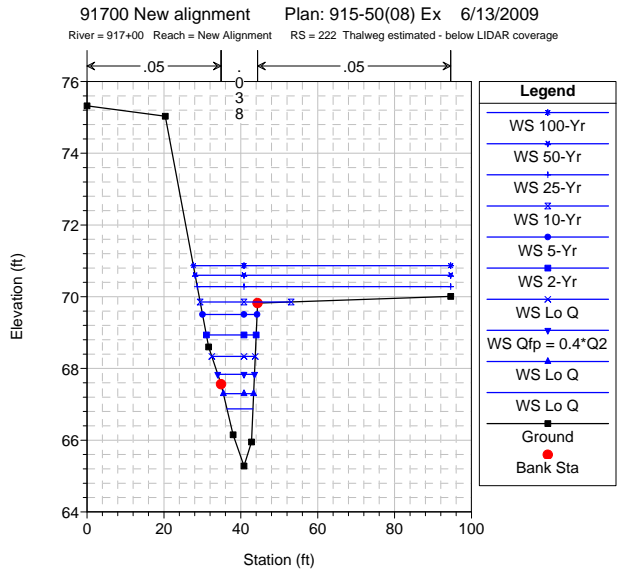
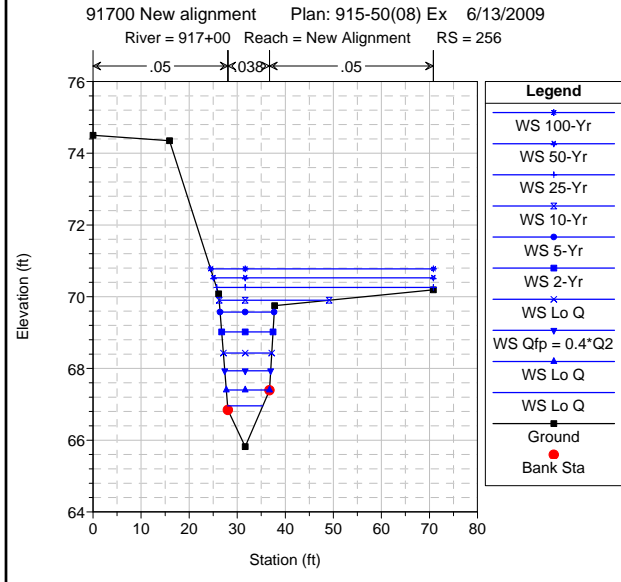
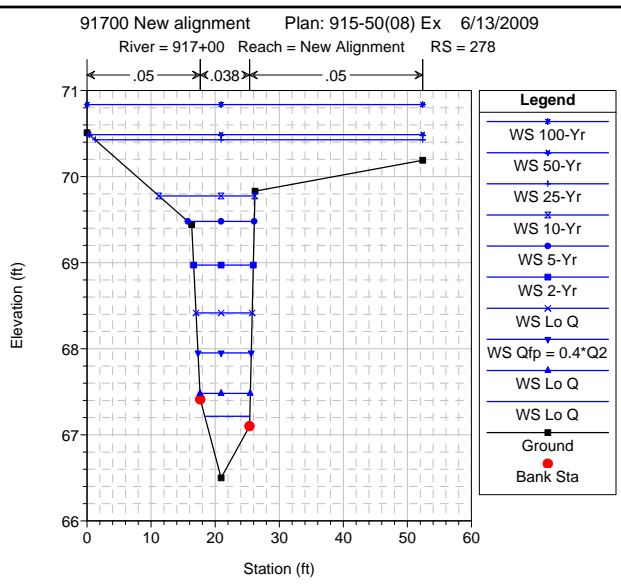
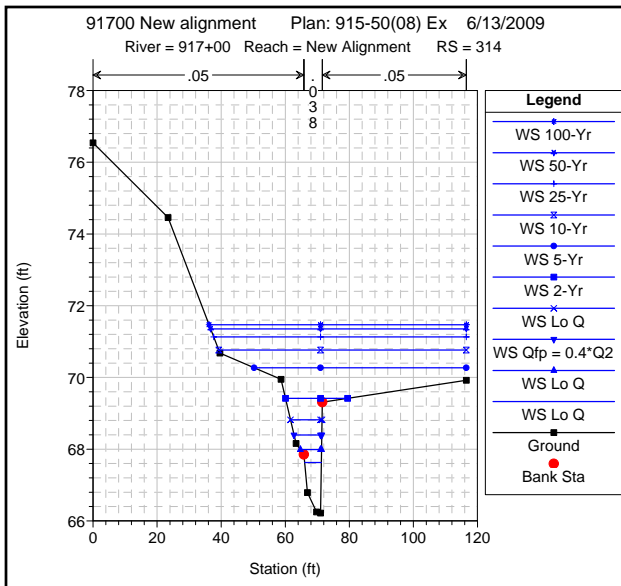

91700 New alignment Plan: 915-50(08) Ex 6/13/2009
 River = 917+00 Reach = New Alignment RS = 1 Thalweg estimated - below LIDAR coverage

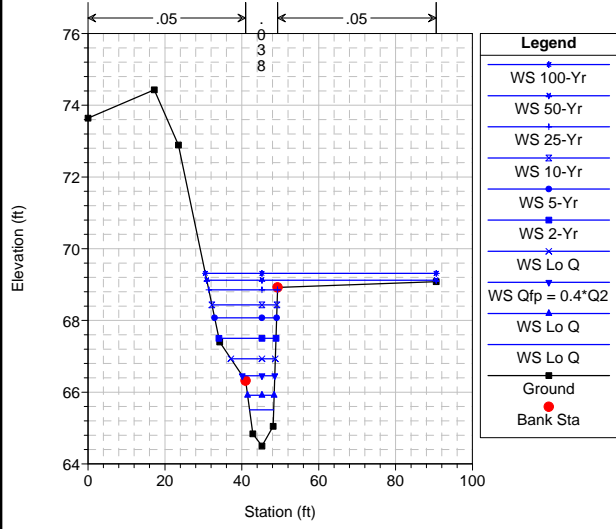

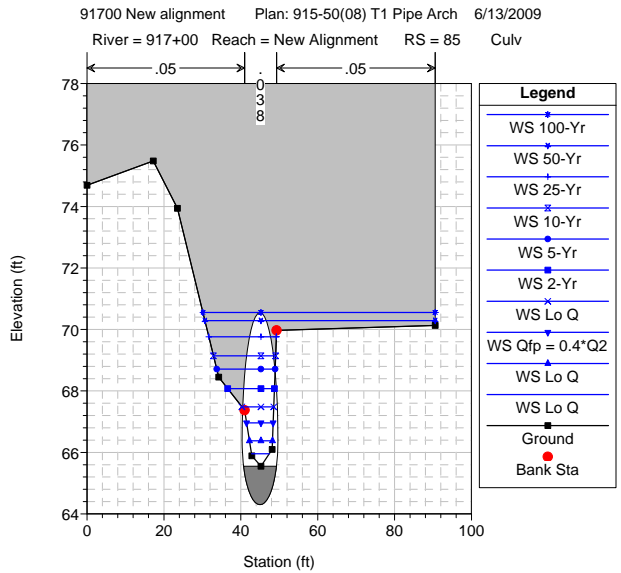
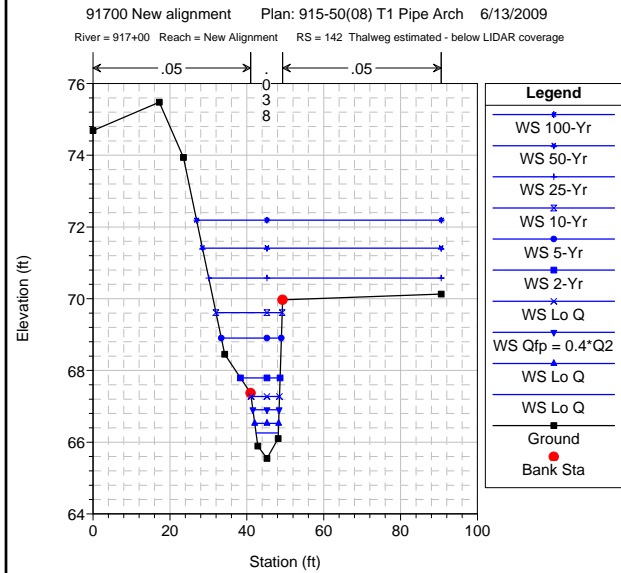
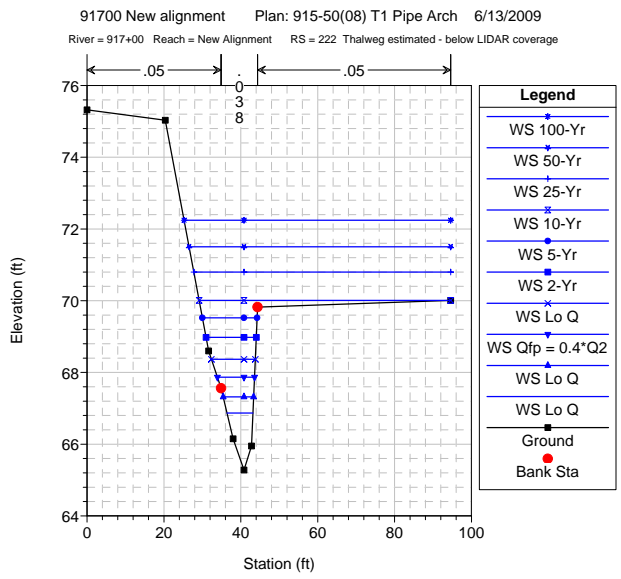
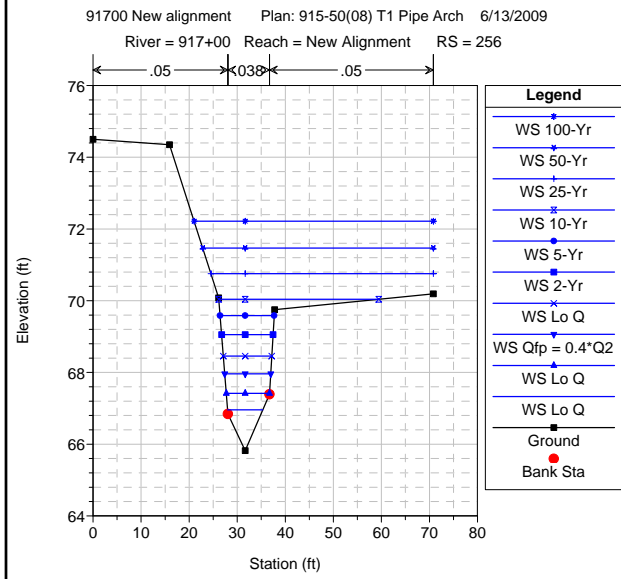
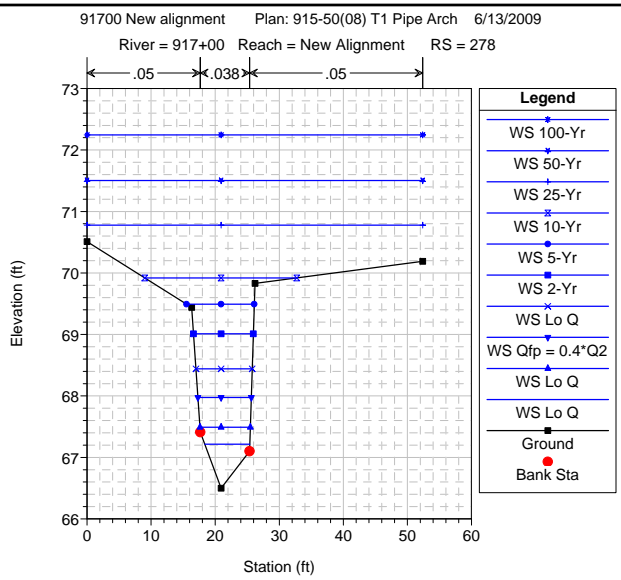
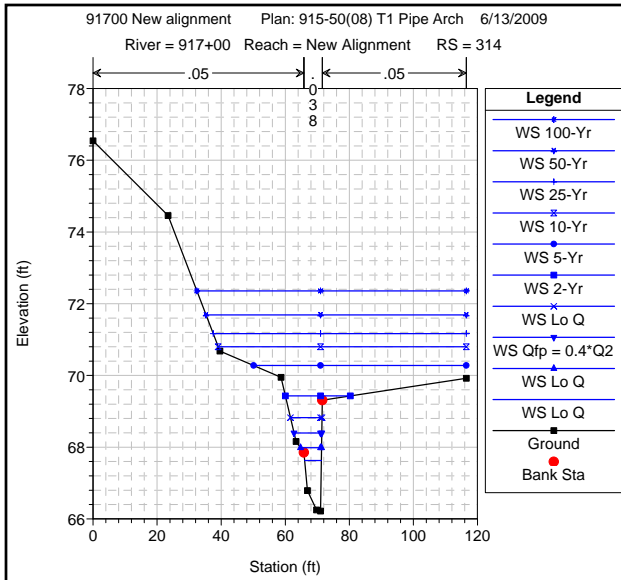

HEC-RAS River: 917+00 Reach: New Alignment

Reach	River Sta	Profile	Plan	Q Total (cfs)	Cum Ch Len (ft)	Min Ch El (ft)	W.S. Elev (ft)	Crit W.S. (ft)	E.G. Elev (ft)	E.G. Slope (ft/ft)	Max Chl Dpth (ft)	Hydr Depth C (ft)	Vel Chnl (ft/s)	Flow Area (sq ft)	Top Width (ft)	Top W Chnl (ft)	Froude # Chl	Shear Chan (lb/sq ft)
New Alignment	1	Lo Q	915(08)-Ex	10.00		64.50	65.51	65.21	65.59	0.006004	1.01	0.71	2.25	4.44	6.27	6.27	0.47	0.24
New Alignment	1	Lo Q	915(08)-T1PA	10.00		64.50	65.51	65.21	65.59	0.006004	1.01	0.71	2.25	4.44	6.27	6.27	0.47	0.24
New Alignment	1	Lo Q	915(08)-Ex	20.00		64.50	65.92	65.47	66.04	0.006010	1.42	1.03	2.81	7.13	6.91	6.91	0.49	0.33
New Alignment	1	Lo Q	915(08)-T1PA	20.00		64.50	65.92	65.47	66.04	0.006010	1.42	1.03	2.81	7.13	6.91	6.91	0.49	0.33
New Alignment	1	Qfp = 0.4*Q2	915(08)-Ex	38.00		64.50	66.46	65.85	66.64	0.006001	1.96	1.46	3.43	11.15	8.44	7.59	0.50	0.45
New Alignment	1	Qfp = 0.4*Q2	915(08)-T1PA	38.00		64.50	66.46	65.85	66.64	0.006001	1.96	1.46	3.43	11.15	8.44	7.59	0.50	0.45
New Alignment	1	Lo Q	915(08)-Ex	60.00		64.50	66.93	66.23	67.17	0.006004	2.43	1.90	4.00	15.88	11.54	7.73	0.51	0.57
New Alignment	1	Lo Q	915(08)-T1PA	60.00		64.50	66.93	66.23	67.17	0.006004	2.43	1.90	4.00	15.88	11.54	7.73	0.51	0.57
New Alignment	1	2-Yr	915(08)-Ex	95.00		64.50	67.50	66.74	67.81	0.006001	3.00	2.43	4.58	23.50	14.84	7.90	0.52	0.70
New Alignment	1	2-Yr	915(08)-T1PA	95.00		64.50	67.50	66.74	67.81	0.006001	3.00	2.43	4.58	23.50	14.84	7.90	0.52	0.70
New Alignment	1	5-Yr	915(08)-Ex	141.00		64.50	68.07	67.32	68.43	0.006003	3.57	2.94	5.09	32.33	16.13	8.07	0.52	0.82
New Alignment	1	5-Yr	915(08)-T1PA	141.00		64.50	68.07	67.32	68.43	0.006003	3.57	2.94	5.09	32.33	16.13	8.07	0.52	0.82
New Alignment	1	10-Yr	915(08)-Ex	175.00		64.50	68.43	67.65	68.82	0.006001	3.93	3.26	5.37	38.33	16.94	8.18	0.52	0.89
New Alignment	1	10-Yr	915(08)-T1PA	175.00		64.50	68.43	67.65	68.82	0.006001	3.93	3.26	5.37	38.33	16.94	8.18	0.52	0.89
New Alignment	1	25-Yr	915(08)-Ex	219.00		64.50	68.85	67.96	69.28	0.006012	4.35	3.62	5.69	45.60	17.88	8.31	0.53	0.96
New Alignment	1	25-Yr	915(08)-T1PA	219.00		64.50	68.85	67.96	69.28	0.006012	4.35	3.62	5.69	45.60	17.88	8.31	0.53	0.96
New Alignment	1	50-Yr	915(08)-Ex	255.00		64.50	69.12	68.19	69.58	0.006007	4.62	3.89	5.94	55.57	19.83	8.33	0.53	1.03
New Alignment	1	50-Yr	915(08)-T1PA	255.00		64.50	69.12	68.19	69.58	0.006007	4.62	3.89	5.94	55.57	19.83	8.33	0.53	1.03
New Alignment	1	100-Yr	915(08)-Ex	291.00		64.50	69.31	68.40	69.77	0.006010	4.81	4.08	6.13	66.92	20.04	8.33	0.54	1.08
New Alignment	1	100-Yr	915(08)-T1PA	291.00		64.50	69.31	68.40	69.77	0.006010	4.81	4.08	6.13	66.92	20.04	8.33	0.54	1.08
New Alignment	83	Lo Q	915(08)-Ex	10.00	80.00	64.60	65.84		65.89	0.002521	1.24	0.90	1.68	5.96	6.64	6.64	0.31	0.12
New Alignment	83	Lo Q	915(08)-T1PA	10.00	80.00	64.60	65.84		65.89	0.002521	1.24	0.90	1.68	5.96	6.64	6.64	0.31	0.12
New Alignment	83	Lo Q	915(08)-Ex	20.00	80.00	64.60	66.30		66.37	0.002969	1.70	1.24	2.19	9.13	7.35	7.35	0.35	0.19
New Alignment	83	Lo Q	915(08)-T1PA	20.00	80.00	64.60	66.30		66.37	0.002969	1.70	1.24	2.19	9.13	7.35	7.35	0.35	0.19
New Alignment	83	Qfp = 0.4*Q2	915(08)-Ex	38.00	80.00	64.60	66.87		66.99	0.003222	2.27	1.75	2.79	14.10	10.48	7.68	0.37	0.28
New Alignment	83	Qfp = 0.4*Q2	915(08)-T1PA	38.00	80.00	64.60	66.87		66.99	0.003222	2.27	1.75	2.79	14.10	10.48	7.68	0.37	0.28
New Alignment	83	Lo Q	915(08)-Ex	60.00	80.00	64.60	67.38		67.54	0.003385	2.78	2.22	3.28	20.26	13.80	7.83	0.39	0.37
New Alignment	83	Lo Q	915(08)-T1PA	60.00	80.00	64.60	67.38		67.54	0.003385	2.78	2.22	3.28	20.26	13.80	7.83	0.39	0.37
New Alignment	83	2-Yr	915(08)-Ex	95.00	80.00	64.60	67.98		68.18	0.003503	3.38	2.77	3.76	29.26	15.69	8.02	0.40	0.45
New Alignment	83	2-Yr	915(08)-T1PA	95.00	80.00	64.60	67.98		68.18	0.003503	3.38	2.77	3.76	29.26	15.69	8.02	0.40	0.45
New Alignment	83	5-Yr	915(08)-Ex	141.00	80.00	64.60	68.57		68.81	0.003744	3.97	3.29	4.27	38.92	17.02	8.19	0.41	0.56
New Alignment	83	5-Yr	915(08)-T1PA	141.00	80.00	64.60	68.57		68.81	0.003744	3.97	3.29	4.27	38.92	17.02	8.19	0.41	0.56
New Alignment	83	10-Yr	915(08)-Ex	175.00	80.00	64.60	68.94		69.22	0.003879	4.34	3.62	4.56	45.41	17.86	8.31	0.42	0.62
New Alignment	83	10-Yr	915(08)-T1PA	175.00	80.00	64.60	68.94		69.22	0.003879	4.34	3.62	4.56	45.41	17.86	8.31	0.42	0.62
New Alignment	83	25-Yr	915(08)-Ex	219.00	80.00	64.60	69.38		69.66	0.003551	4.78	4.05	4.69	65.15	19.99	8.33	0.41	0.63
New Alignment	83	25-Yr	915(08)-T1PA	219.00	80.00	64.60	69.38		69.66	0.003551	4.78	4.05	4.69	65.15	19.99	8.33	0.41	0.63
New Alignment	83	50-Yr	915(08)-Ex	255.00	80.00	64.60	69.69		69.93	0.003090	5.09	4.35	4.60	83.69	20.59	8.33	0.39	0.59
New Alignment	83	50-Yr	915(08)-T1PA	255.00	80.00	64.60	69.69		69.93	0.003090	5.09	4.35	4.60	83.69	20.59	8.33	0.39	0.59
New Alignment	83	100-Yr	915(08)-Ex	291.00	80.00	64.60	69.89		70.13	0.003038	5.29	4.55	4.70	95.77	20.97	8.33	0.39	0.61
New Alignment	83	100-Yr	915(08)-T1PA	291.00	80.00	64.60	69.89		70.13	0.003038	5.29	4.55	4.70	95.77	20.97	8.33	0.39	0.61
New Alignment	142	Lo Q	915(08)-Ex	10.00	155.00	65.55	66.26	66.26	66.48	0.029765	0.71	0.45	3.83	2.61	5.80	5.80	1.00	0.79
New Alignment	142	Lo Q	915(08)-T1PA	10.00	155.00	65.55	66.26	66.26	66.48	0.029765	0.71	0.45	3.83	2.61	5.80	5.80	1.00	0.79
New Alignment	142	Lo Q	915(08)-Ex	20.00	155.00	65.55	66.62	66.52	66.87	0.018874	1.07	0.76	4.15	4.81	6.37	6.37	0.84	0.80
New Alignment	142	Lo Q	915(08)-T1PA	20.00	155.00	65.55	66.62	66.52	66.87	0.018874	1.07	0.76	4.15	4.81	6.37	6.37	0.84	0.80
New Alignment	142	Qfp = 0.4*Q2	915(08)-Ex	38.00	155.00	65.55	67.17	66.90	67.47	0.012854	1.62	1.18	4.44	8.56	7.23	7.23	0.72	0.80
New Alignment	142	Qfp = 0.4*Q2	915(08)-T1PA	38.00	155.00	65.55	67.17	66.90	67.47	0.012854	1.62	1.18	4.44	8.56	7.23	7.23	0.72	0.80
New Alignment	142	Lo Q	915(08)-Ex	60.00	155.00	65.55	67.65	67.27	68.02	0.011162	2.10	1.59	4.92	12.40	9.37	7.63	0.69	0.90
New Alignment	142	Lo Q	915(08)-T1PA	60.00	155.00	65.55	67.65	67.27	68.02	0.011162	2.10	1.59	4.92	12.40	9.37	7.63	0.69	0.90
New Alignment	142	2-Yr	915(08)-Ex	95.00	155.00	65.55	68.21	67.79	68.67	0.010158	2.66	2.12	5.52	18.75	13.07	7.80	0.67	1.05
New Alignment	142	2-Yr	915(08)-T1PA	95.00	155.00	65.55	68.21	67.79	68.67	0.010158	2.66	2.12	5.52	18.75	13.07	7.80	0.67	1.05
New Alignment	142	5-Yr	915(08)-Ex	141.00	155.00	65.55	68.81	68.37	69.31	0.009080	3.26	2.66	5.93	27.41	15.42	7.98	0.64	1.14
New Alignment	142	5-Yr	915(08)-T1PA	141.00	155.00	65.55	68.81	68.37	69.31	0.009080	3.26	2.66	5.93	27.41	15.42	7.98	0.64	1.14
New Alignment	142	10-Yr	915(08)-Ex	175.00	155.00	65.55	69.19	68.70	69.70	0.008511	3.64	3.00	6.12	33.41	16.28	8.09	0.62	1.17
New Alignment	142	10-Yr	915(08)-T1PA	175.00	155.00	65.55	69.19	68.70	69.70	0.008511	3.64	3.00	6.12	33.41	16.28	8.09	0.62	1.17
New Alignment	142	25-Yr	915(08)-Ex	219.00	155.00	65.55	69.57	69.08	70.13	0.008498	4.02	3.34	6.48	39.86	17.15	8.21	0.62	1.28
New Alignment	142	25-Yr	915(08)-T1PA	219.00	155.00	65.55	69.57	69.08	70.13	0.008498	4.02	3.34	6.48	39.86	17.15	8.21	0.62	1.28
New Alignment	142	50-Yr	915(08)-Ex	255.00	155.00	65.55	70.58	69.01	70.77	0.002501	5.03	4.29	4.09	79.78	20.46	8.33	0.35	0.47
New Alignment	142	50-Yr	915(08)-T1PA	255.00	155.00	65.55	70.58	69.01	70.77	0.002501	5.03	4.29	4.09	79.78	20.46	8.33	0.35	0.47
New Alignment	142	100-Yr	915(08)-Ex	291.00	155.00	65.55	71.41	69.24	71.50	0.001111	5.86	5.12	3.07	130.84	22.09	8.33	0.24	0.25
New Alignment	142	100-Yr	915(08)-T1PA	291.00	155.00	65.55	71.41	69.24	71.50	0.001111	5.86	5.12	3.07	130.84	22.09	8.33	0.24	0.25
New Alignment	222	Lo Q	915(08)-Ex	10.00	235.00	65.28	66.87		66.91	0.001997	1.59	0.96	1.55	6.47	6.75	6.75	0.28	0.10

HEC-RAS River: 917+00 Reach: New Alignment (Continued)

Reach	River Sta	Profile	Plan	Q Total (cfs)	Cum Ch Len (ft)	Min Ch El (ft)	W.S. Elev (ft)	Crit W.S. (ft)	E.G. Elev (ft)	E.G. Slope (ft/ft)	Max Chl Dpth (ft)	Hydr Depth C (ft)	Vel Chnl (ft/s)	Flow Area (sq ft)	Top Width (ft)	Top W Chnl (ft)	Froude # Chl	Shear Chan (lb/sq ft)
New Alignment	222	Lo Q	915(08)-T1PA	10.00	235.00	65.28	66.87		66.91	0.002009	1.59	0.96	1.55	6.45	6.75	6.75	0.28	0.10
New Alignment	222	Lo Q	915(08)-Ex	20.00	235.00	65.28	67.30		67.37	0.002723	2.02	1.22	2.09	9.59	7.88	7.88	0.33	0.18
New Alignment	222	Lo Q	915(08)-T1PA	20.00	235.00	65.28	67.32		67.39	0.002590	2.04	1.23	2.05	9.77	7.94	7.94	0.33	0.17
New Alignment	222	Qfp = 0.4*Q2	915(08)-Ex	38.00	235.00	65.28	67.84		67.95	0.003184	2.56	1.63	2.69	14.23	9.54	8.68	0.37	0.27
New Alignment	222	Qfp = 0.4*Q2	915(08)-T1PA	38.00	235.00	65.28	67.87		67.98	0.002989	2.59	1.66	2.63	14.55	9.65	8.69	0.36	0.26
New Alignment	222	Lo Q	915(08)-Ex	60.00	235.00	65.28	68.34		68.49	0.003354	3.06	2.08	3.20	19.44	11.30	8.88	0.39	0.35
New Alignment	222	Lo Q	915(08)-T1PA	60.00	235.00	65.28	68.37		68.52	0.003191	3.09	2.11	3.14	19.81	11.41	8.90	0.38	0.34
New Alignment	222	2-Yr	915(08)-Ex	95.00	235.00	65.28	68.93		69.15	0.003643	3.65	2.62	3.80	26.77	12.95	9.13	0.41	0.47
New Alignment	222	2-Yr	915(08)-T1PA	95.00	235.00	65.28	68.98		69.19	0.003449	3.70	2.66	3.73	27.34	13.05	9.15	0.40	0.45
New Alignment	222	5-Yr	915(08)-Ex	141.00	235.00	65.28	69.51		69.80	0.004142	4.23	3.12	4.48	34.52	14.19	9.36	0.45	0.61
New Alignment	222	5-Yr	915(08)-T1PA	141.00	235.00	65.28	69.52		69.81	0.004076	4.24	3.13	4.45	34.73	14.22	9.37	0.44	0.61
New Alignment	222	10-Yr	915(08)-Ex	175.00	235.00	65.28	69.85		70.20	0.004462	4.57	3.42	4.90	39.72	23.68	9.49	0.47	0.72
New Alignment	222	10-Yr	915(08)-T1PA	175.00	235.00	65.28	70.01		70.31	0.003702	4.73	3.58	4.60	46.75	65.43	9.49	0.43	0.62
New Alignment	222	25-Yr	915(08)-Ex	219.00	235.00	65.28	70.28	68.97	70.60	0.003828	5.00	3.85	4.91	64.60	65.91	9.49	0.44	0.69
New Alignment	222	25-Yr	915(08)-T1PA	219.00	235.00	65.28	70.80		70.94	0.001694	5.52	4.37	3.55	98.85	66.81	9.49	0.30	0.35
New Alignment	222	50-Yr	915(08)-Ex	255.00	235.00	65.28	70.60		70.86	0.003131	5.32	4.16	4.68	85.47	66.46	9.49	0.40	0.61
New Alignment	222	50-Yr	915(08)-T1PA	255.00	235.00	65.28	71.50		71.58	0.000873	6.22	5.07	2.82	146.45	68.05	9.49	0.22	0.21
New Alignment	222	100-Yr	915(08)-Ex	291.00	235.00	65.28	70.87		71.09	0.002701	5.59	4.43	4.53	103.40	66.93	9.49	0.38	0.56
New Alignment	222	100-Yr	915(08)-T1PA	291.00	235.00	65.28	72.24		72.29	0.000500	6.96	5.81	2.34	197.31	69.34	9.49	0.17	0.14
New Alignment	256	Lo Q	915(08)-Ex	10.00	269.00	65.82	66.96		67.04	0.007293	1.14	0.60	2.30	4.34	7.33	7.26	0.53	0.26
New Alignment	256	Lo Q	915(08)-T1PA	10.00	269.00	65.82	66.96		67.04	0.007348	1.14	0.60	2.31	4.33	7.33	7.26	0.53	0.26
New Alignment	256	Lo Q	915(08)-Ex	20.00	269.00	65.82	67.40		67.50	0.005063	1.58	0.91	2.54	7.96	8.99	8.66	0.47	0.28
New Alignment	256	Lo Q	915(08)-T1PA	20.00	269.00	65.82	67.42		67.51	0.004762	1.60	0.93	2.49	8.11	9.01	8.66	0.46	0.26
New Alignment	256	Qfp = 0.4*Q2	915(08)-Ex	38.00	269.00	65.82	67.93		68.07	0.003858	2.11	1.44	3.01	12.92	9.55	8.66	0.44	0.33
New Alignment	256	Qfp = 0.4*Q2	915(08)-T1PA	38.00	269.00	65.82	67.96		68.10	0.003631	2.14	1.47	2.96	13.17	9.57	8.66	0.43	0.32
New Alignment	256	Lo Q	915(08)-Ex	60.00	269.00	65.82	68.43		68.62	0.003554	2.61	1.94	3.52	17.77	10.06	8.66	0.45	0.41
New Alignment	256	Lo Q	915(08)-T1PA	60.00	269.00	65.82	68.46		68.64	0.003392	2.64	1.97	3.47	18.04	10.09	8.66	0.44	0.40
New Alignment	256	2-Yr	915(08)-Ex	95.00	269.00	65.82	69.02		69.29	0.003618	3.20	2.53	4.24	23.87	10.67	8.66	0.47	0.55
New Alignment	256	2-Yr	915(08)-T1PA	95.00	269.00	65.82	69.06		69.32	0.003442	3.24	2.56	4.18	24.27	10.71	8.66	0.46	0.53
New Alignment	256	5-Yr	915(08)-Ex	141.00	269.00	65.82	69.57		69.97	0.004041	3.75	3.08	5.12	29.96	11.24	8.66	0.51	0.74
New Alignment	256	5-Yr	915(08)-T1PA	141.00	269.00	65.82	69.59		69.98	0.003984	3.77	3.10	5.09	30.10	11.26	8.66	0.51	0.74
New Alignment	256	10-Yr	915(08)-Ex	175.00	269.00	65.82	69.90		70.39	0.004421	4.08	3.41	5.72	34.55	22.88	8.66	0.55	0.90
New Alignment	256	10-Yr	915(08)-T1PA	175.00	269.00	65.82	70.04		70.48	0.003796	4.22	3.55	5.45	38.42	33.29	8.66	0.51	0.81
New Alignment	256	25-Yr	915(08)-Ex	219.00	269.00	65.82	70.26		70.81	0.004550	4.44	3.77	6.21	47.36	45.09	8.66	0.56	1.03
New Alignment	256	25-Yr	915(08)-T1PA	219.00	269.00	65.82	70.76		71.05	0.002329	4.94	4.26	4.82	70.11	46.28	8.66	0.41	0.59
New Alignment	256	50-Yr	915(08)-Ex	255.00	269.00	65.82	70.53		71.07	0.004278	4.71	4.04	6.30	59.65	45.73	8.66	0.55	1.03
New Alignment	256	50-Yr	915(08)-T1PA	255.00	269.00	65.82	71.47		71.65	0.001325	5.65	4.98	4.03	103.70	47.99	8.66	0.32	0.39
New Alignment	256	100-Yr	915(08)-Ex	291.00	269.00	65.82	70.78		71.29	0.003999	4.96	4.29	6.34	71.09	46.33	8.66	0.54	1.02
New Alignment	256	100-Yr	915(08)-T1PA	291.00	269.00	65.82	72.22		72.34	0.000804	6.40	5.73	3.45	140.27	49.78	8.66	0.25	0.28
New Alignment	278	Lo Q	915(08)-Ex	10.00	291.00	66.50	67.22	67.22	67.42	0.030409	0.72	0.39	3.62	2.76	7.03	6.99	1.02	0.74
New Alignment	278	Lo Q	915(08)-T1PA	10.00	291.00	66.50	67.22	67.22	67.42	0.030409	0.72	0.39	3.62	2.76	7.03	6.99	1.02	0.74
New Alignment	278	Lo Q	915(08)-Ex	20.00	291.00	66.50	67.48	67.45	67.76	0.022808	0.98	0.62	4.22	4.76	7.85	7.68	0.95	0.86
New Alignment	278	Lo Q	915(08)-T1PA	20.00	291.00	66.50	67.49	67.45	67.76	0.021823	0.99	0.63	4.16	4.83	7.86	7.68	0.93	0.83
New Alignment	278	Qfp = 0.4*Q2	915(08)-Ex	38.00	291.00	66.50	67.95		68.27	0.012413	1.45	1.09	4.54	8.55	8.30	7.68	0.77	0.82
New Alignment	278	Qfp = 0.4*Q2	915(08)-T1PA	38.00	291.00	66.50	67.97		68.28	0.011562	1.47	1.11	4.44	8.74	8.33	7.68	0.74	0.78
New Alignment	278	Lo Q	915(08)-Ex	60.00	291.00	66.50	68.42		68.80	0.009317	1.92	1.55	4.98	12.51	8.76	7.68	0.71	0.88
New Alignment	278	Lo Q	915(08)-T1PA	60.00	291.00	66.50	68.44		68.81	0.008901	1.94	1.58	4.90	12.74	8.78	7.68	0.69	0.85
New Alignment	278	2-Yr	915(08)-Ex	95.00	291.00	66.50	68.97		69.48	0.008257	2.47	2.11	5.76	17.53	9.30	7.68	0.70	1.06
New Alignment	278	2-Yr	915(08)-T1PA	95.00	291.00	66.50	69.01		69.50	0.007766	2.51	2.14	5.65	17.89	9.34	7.68	0.68	1.02
New Alignment	278	5-Yr	915(08)-Ex	141.00	291.00	66.50	69.48		70.19	0.008750	2.98	2.61	6.84	22.39	10.37	7.68	0.75	1.40
New Alignment	278	5-Yr	915(08)-T1PA	141.00	291.00	66.50	69.49		70.19	0.008612	2.99	2.63	6.81	22.53	10.57	7.68	0.74	1.38
New Alignment	278	10-Yr	915(08)-Ex	175.00	291.00	66.50	69.78	69.35	70.64	0.009309	3.28	2.91	7.58	26.14	14.98	7.68	0.78	1.66
New Alignment	278	10-Yr	915(08)-T1PA	175.00	291.00	66.50	69.92	69.35	70.69	0.007839	3.42	3.05	7.18	28.76	23.72	7.68	0.72	1.46
New Alignment	278	25-Yr	915(08)-Ex	219.00	291.00	66.50	70.43	70.43	71.05	0.005779	3.93	3.56	6.83	50.06	51.12	7.68	0.64	1.26
New Alignment	278	25-Yr	915(08)-T1PA	219.00	291.00	66.50	70.78		71.13	0.003239	4.28	3.91	5.45	68.36	52.39	7.68	0.49	0.77
New Alignment	278	50-Yr	915(08)-Ex	255.00	291.00	66.50	70.49		71.26	0.007098	3.99	3.62	7.66	53.19	52.04	7.68	0.71	1.57
New Alignment	278	50-Yr	915(08)-T1PA	255.00	291.00	66.50	71.50		71.68	0.001554	5.00	4.64	4.23	106.42	52.39	7.68	0.35	0.44
New Alignment	278	100-Yr	915(08)-Ex	291.00	291.00	66.50	70.84		71.40	0.005205	4.34	3.97	6.97	71.46	52.39	7.68	0.62	1.26
New Alignment	278	100-Yr	915(08)-T1PA	291.00	291.00	66.50	72.25		72.36	0.000878	5.75	5.38	3.51	145.31	52.39	7.68	0.27	0.29
New Alignment	314	Lo Q	915(08)-Ex	10.00	327.00	66.22	67.63		67.68	0.002958	1.41	1.05	1.84	5.45	5.21	5.21	0.32	0.15
New Alignment	314	Lo Q	915(08)-T1PA	10.00	327.00	66.22	67.63		67.68	0.002958	1.41	1.05	1.84	5.45	5.21	5.21	0.32	0.15

HEC-RAS River: 917+00 Reach: New Alignment (Continued)

Reach	River Sta	Profile	Plan	Q Total (cfs)	Cum Ch Len (ft)	Min Ch El (ft)	W.S. Elev (ft)	Crit W.S. (ft)	E.G. Elev (ft)	E.G. Slope (ft/ft)	Max Chl Dpth (ft)	Hydr Depth C (ft)	Vel Chnl (ft/s)	Flow Area (sq ft)	Top Width (ft)	Top W Chnl (ft)	Froude # Chl	Shear Chan (lb/sq ft)
New Alignment	314	Lo Q	915(08)-Ex	20.00	327.00	66.22	67.99		68.10	0.004850	1.77	1.35	2.70	7.47	6.60	5.49	0.41	0.30
New Alignment	314	Lo Q	915(08)-T1PA	20.00	327.00	66.22	67.99		68.10	0.004887	1.77	1.34	2.71	7.44	6.58	5.49	0.41	0.30
New Alignment	314	Qfp = 0.4*Q2	915(08)-Ex	38.00	327.00	66.22	68.40		68.61	0.007269	2.18	1.73	3.81	10.68	8.66	5.56	0.51	0.55
New Alignment	314	Qfp = 0.4*Q2	915(08)-T1PA	38.00	327.00	66.22	68.39		68.61	0.007296	2.17	1.73	3.82	10.66	8.66	5.56	0.51	0.56
New Alignment	314	Lo Q	915(08)-Ex	60.00	327.00	66.22	68.82		69.12	0.008396	2.60	2.13	4.58	14.60	9.84	5.64	0.55	0.76
New Alignment	314	Lo Q	915(08)-T1PA	60.00	327.00	66.22	68.82		69.13	0.008347	2.60	2.13	4.57	14.64	9.85	5.64	0.55	0.75
New Alignment	314	2-Yr	915(08)-Ex	95.00	327.00	66.22	69.42		69.79	0.008450	3.20	2.69	5.22	21.40	19.38	5.72	0.56	0.92
New Alignment	314	2-Yr	915(08)-T1PA	95.00	327.00	66.22	69.43		69.80	0.008298	3.21	2.71	5.18	21.63	20.26	5.72	0.56	0.91
New Alignment	314	5-Yr	915(08)-Ex	141.00	327.00	66.22	70.27	69.32	70.43	0.003558	4.05	3.55	4.07	62.41	66.22	5.72	0.38	0.51
New Alignment	314	5-Yr	915(08)-T1PA	141.00	327.00	66.22	70.28	69.32	70.44	0.003514	4.06	3.55	4.05	62.79	66.36	5.72	0.38	0.51
New Alignment	314	10-Yr	915(08)-Ex	175.00	327.00	66.22	70.76		70.85	0.001906	4.54	4.04	3.25	98.06	77.27	5.72	0.28	0.31
New Alignment	314	10-Yr	915(08)-T1PA	175.00	327.00	66.22	70.80		70.88	0.001766	4.58	4.08	3.14	100.89	77.43	5.72	0.27	0.29
New Alignment	314	25-Yr	915(08)-Ex	219.00	327.00	66.22	71.13		71.20	0.001470	4.91	4.41	3.02	126.76	78.85	5.72	0.25	0.26
New Alignment	314	25-Yr	915(08)-T1PA	219.00	327.00	66.22	71.17		71.23	0.001382	4.95	4.44	2.94	129.55	79.00	5.72	0.25	0.25
New Alignment	314	50-Yr	915(08)-Ex	255.00	327.00	66.22	71.35		71.42	0.001370	5.13	4.63	3.01	144.46	79.80	5.72	0.25	0.26
New Alignment	314	50-Yr	915(08)-T1PA	255.00	327.00	66.22	71.69		71.73	0.000830	5.47	4.97	2.46	171.56	81.24	5.72	0.19	0.17
New Alignment	314	100-Yr	915(08)-Ex	291.00	327.00	66.22	71.47		71.54	0.001492	5.25	4.74	3.20	153.66	80.29	5.72	0.26	0.29
New Alignment	314	100-Yr	915(08)-T1PA	291.00	327.00	66.22	72.36		72.39	0.000473	6.14	5.63	2.02	226.68	84.10	5.72	0.15	0.11

Tributary 1102+19 HEC-RAS

Companion 2006 Stream and Habitat Inventory (S&HI) station 1123+25
Model based on ADOT&PF project datum

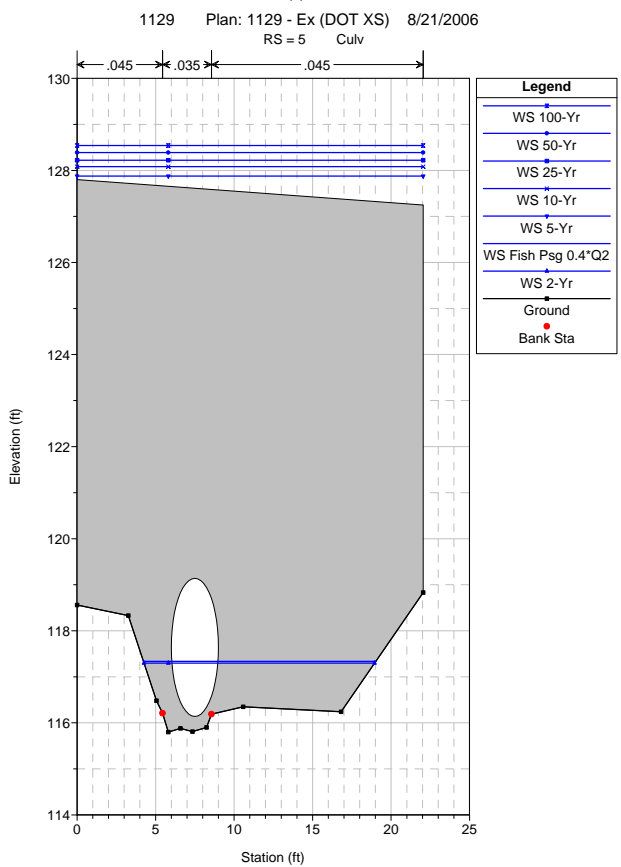
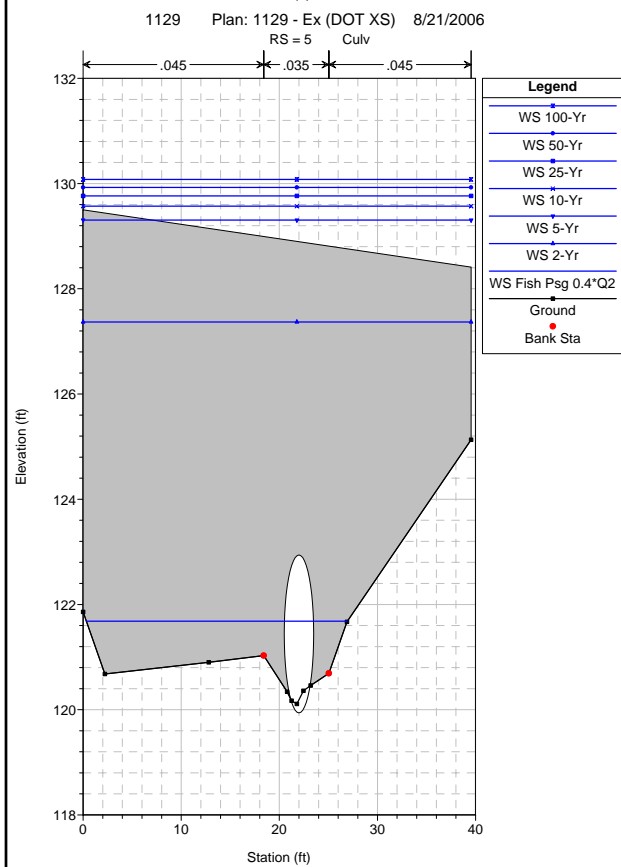
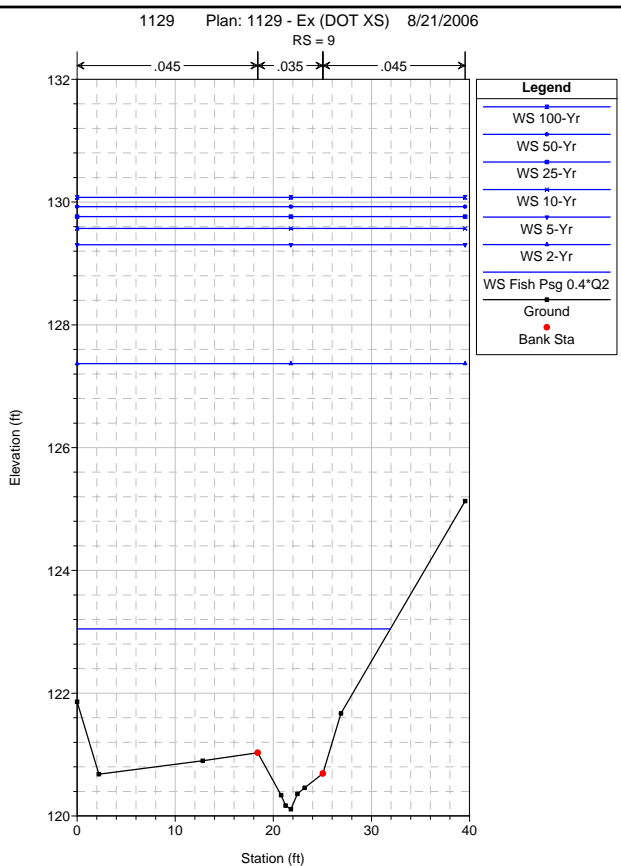
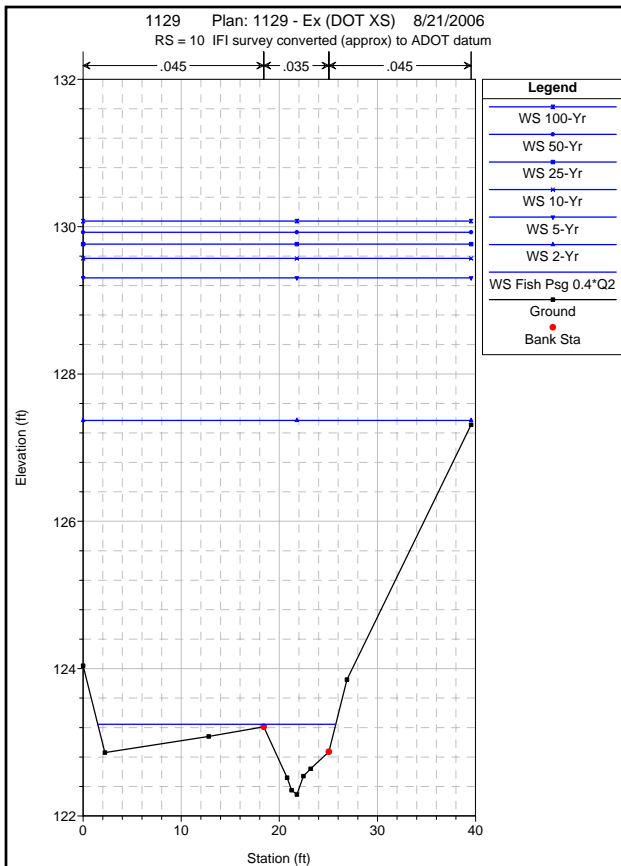

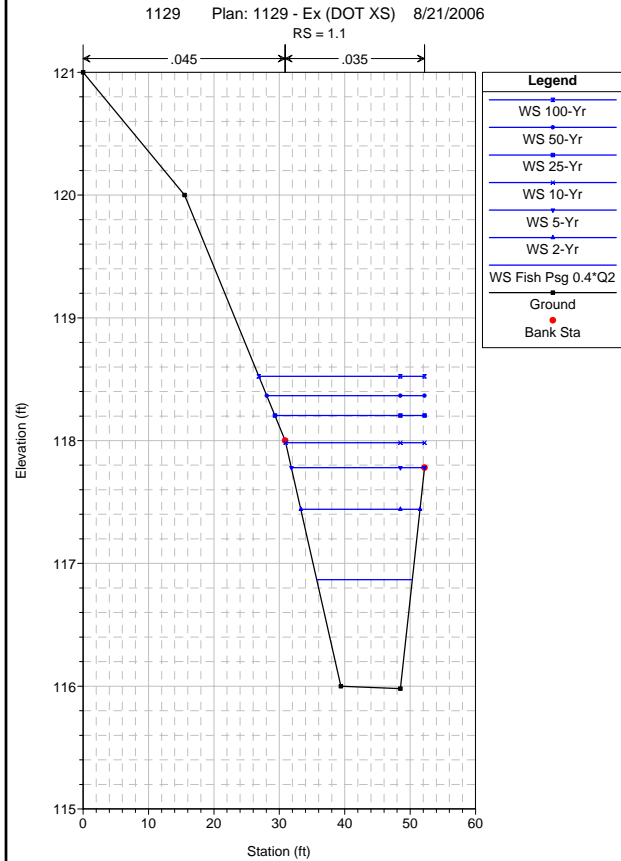
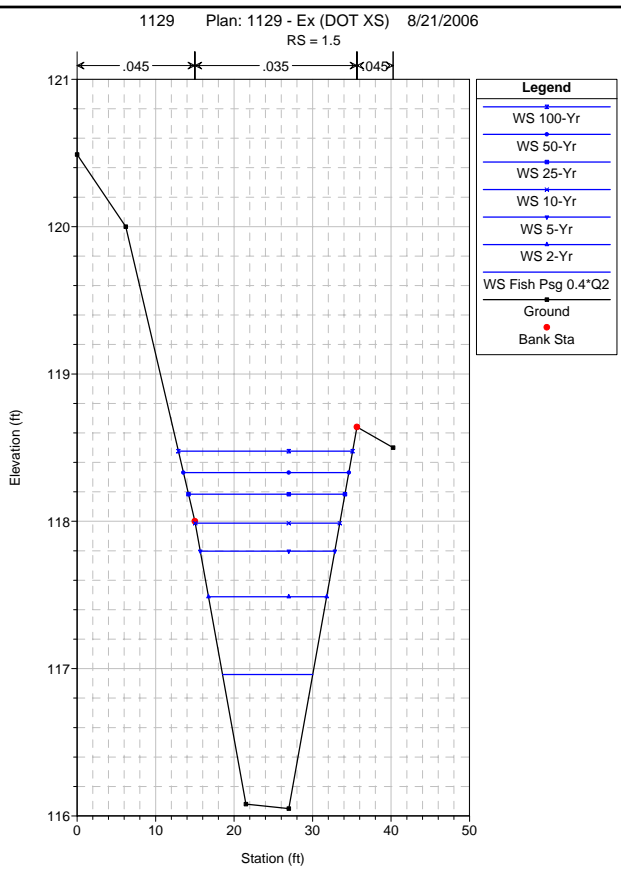
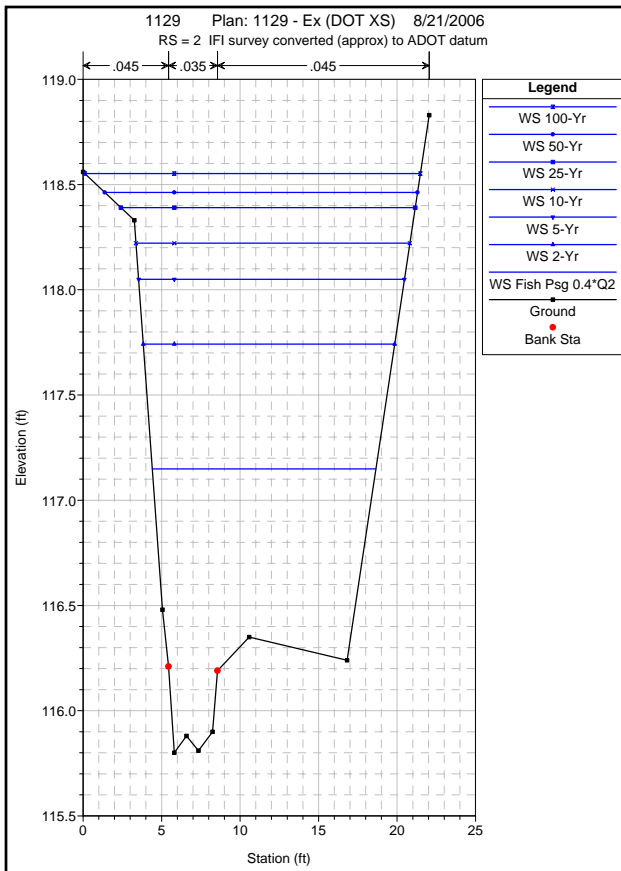

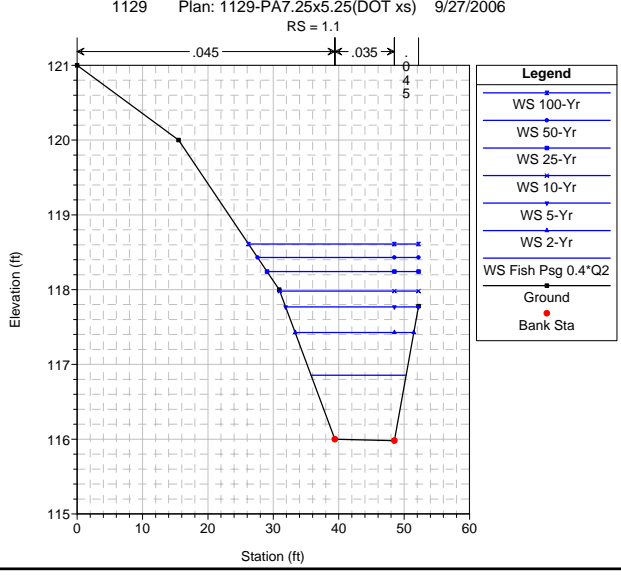
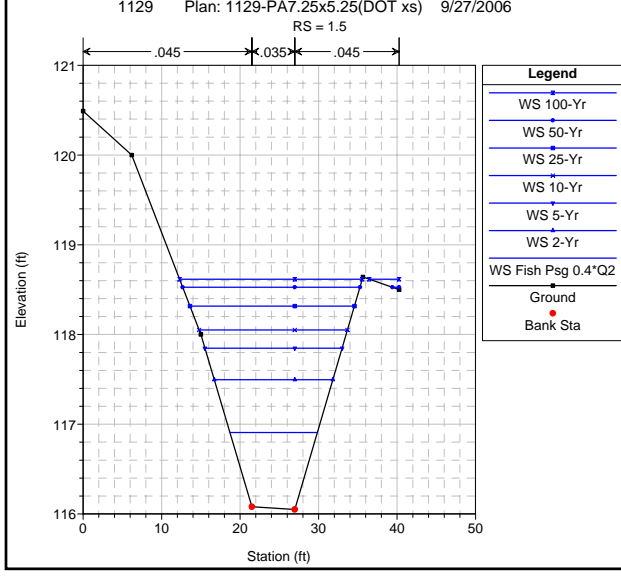
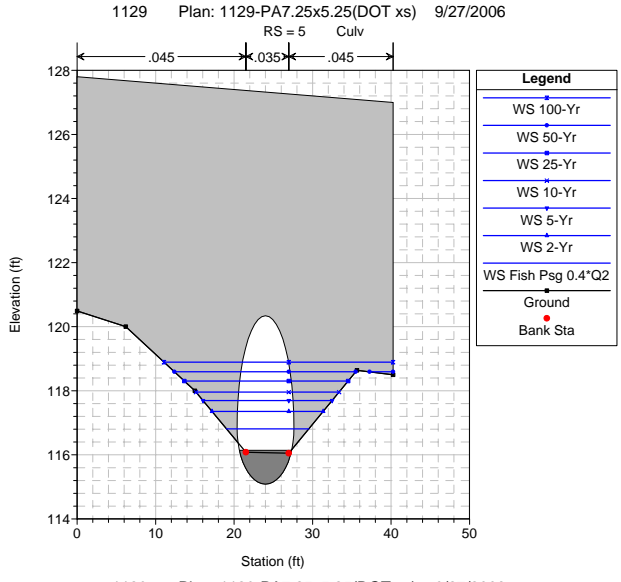
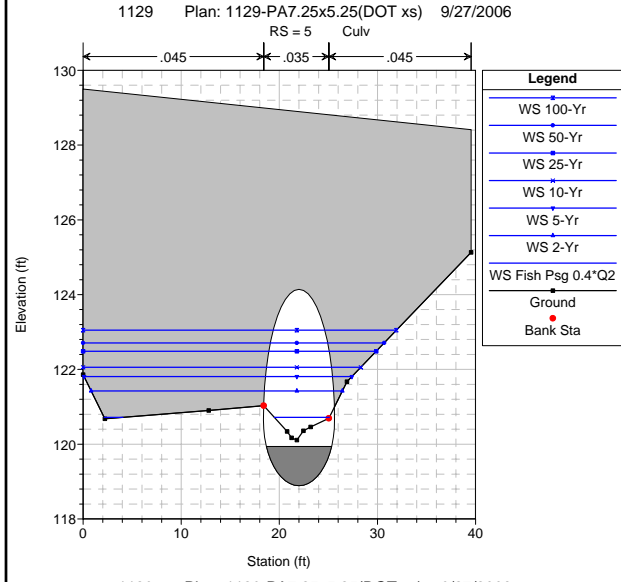
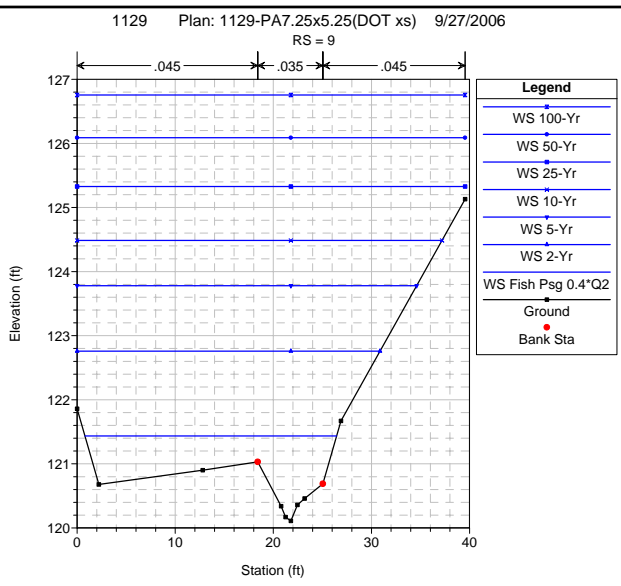
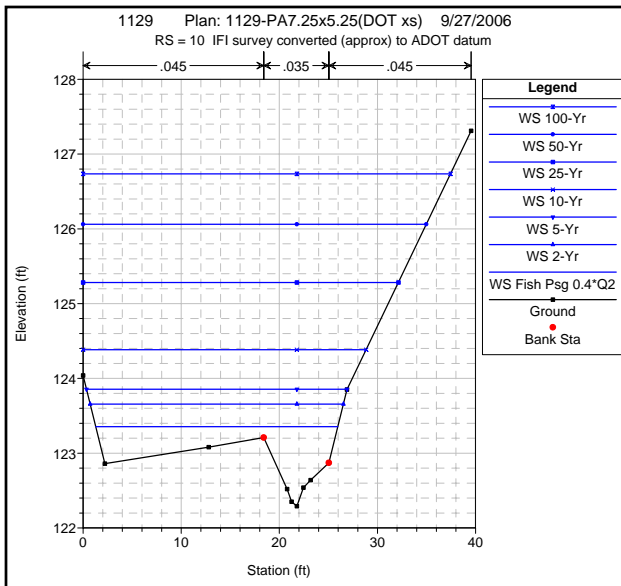

HEC-RAS River: 1129 Reach: 1129

Reach	River Sta	Profile	Plan	Q Total (cfs)	Cum Ch Len (ft)	Min Ch El (ft)	W.S. Elev (ft)	Crit W.S. (ft)	E.G. Elev (ft)	E.G. Slope (ft/ft)	Max Chl Dpth (ft)	Hydr Depth C (ft)	Vel Chnl (ft/s)	Flow Area (sq ft)	Top Width (ft)	Top W Chnl (ft)	Froude # Chl	Shear Chan (lb/sq ft)
1129	1.1	5-cfs	1129pa7dot	5.00		115.98	116.31	116.20	116.35	0.007001	0.33	0.32	1.65	3.19	11.08	9.10	0.52	0.14
1129	1.1	5-cfs	1129Ex(dot)	5.00		115.98	116.31	116.20	116.35	0.007001	0.33	0.29	1.55	3.23	11.10	11.10	0.51	0.13
1129	1.1	10-cfs	1129pa7dot	10.00		115.98	116.46	116.32	116.53	0.006992	0.48	0.47	2.16	5.01	12.06	9.10	0.55	0.21
1129	1.1	10-cfs	1129Ex(dot)	10.00		115.98	116.47	116.31	116.53	0.007005	0.49	0.42	1.97	5.07	12.10	12.10	0.54	0.18
1129	1.1	Fish Psg 0.4*Q2	1129pa7dot	29.00		115.98	116.86	116.63	117.00	0.007004	0.88	0.87	3.23	10.22	14.54	9.10	0.61	0.38
1129	1.1	Fish Psg 0.4*Q2	1129Ex(dot)	29.00		115.98	116.87	116.62	116.99	0.007001	0.89	0.71	2.79	10.39	14.61	14.61	0.58	0.30
1129	1.1	50-cfs	1129pa7dot	50.00		115.98	117.16	116.90	117.37	0.007004	1.18	1.17	3.95	14.94	16.46	9.10	0.64	0.51
1129	1.1	50-cfs	1129Ex(dot)	50.00		115.98	117.17	116.87	117.34	0.007004	1.19	0.92	3.30	15.16	16.54	16.54	0.61	0.39
1129	1.1	2-Yr	1129pa7dot	73.00		115.98	117.43	117.13	117.70	0.007001	1.45	1.44	4.52	19.56	18.14	9.10	0.67	0.63
1129	1.1	2-Yr	1129Ex(dot)	73.00		115.98	117.44	117.09	117.65	0.007001	1.46	1.09	3.69	19.80	18.22	18.22	0.62	0.46
1129	1.1	5-Yr	1129pa7dot	109.00		115.98	117.77	117.45	118.12	0.007008	1.79	1.78	5.22	26.13	20.30	9.10	0.69	0.78
1129	1.1	5-Yr	1129Ex(dot)	109.00		115.98	117.78	117.38	118.05	0.007005	1.80	1.29	4.14	26.35	20.37	20.37	0.64	0.55
1129	1.1	10-Yr	1129pa7dot	135.00		115.98	117.98	117.64	118.38	0.006999	2.00	1.99	5.62	30.51	21.21	9.10	0.70	0.87
1129	1.1	10-Yr	1129Ex(dot)	135.00		115.98	117.98	117.56	118.29	0.007009	2.00	1.44	4.42	30.57	21.23	21.23	0.65	0.61
1129	1.1	25-Yr	1129pa7dot	170.00		115.98	118.24	117.89	118.70	0.007004	2.26	2.25	6.10	36.31	23.16	9.10	0.72	0.98
1129	1.1	25-Yr	1129Ex(dot)	170.00		115.98	118.20	117.77	118.56	0.007004	2.22	1.66	4.81	35.45	22.87	21.30	0.66	0.69
1129	1.1	50-Yr	1129pa7dot	198.00		115.98	118.43	118.01	118.93	0.007002	2.45	2.44	6.44	40.81	24.61	9.10	0.73	1.07
1129	1.1	50-Yr	1129Ex(dot)	198.00		115.98	118.37	117.92	118.77	0.007002	2.39	1.82	5.10	39.26	24.12	21.30	0.67	0.75
1129	1.1	100-Yr	1129pa7dot	227.00		115.98	118.61	118.20	119.15	0.007001	2.63	2.62	6.75	45.35	25.99	9.10	0.73	1.14
1129	1.1	100-Yr	1129Ex(dot)	227.00		115.98	118.52	118.06	118.97	0.007001	2.54	1.98	5.36	43.16	25.34	21.30	0.67	0.81
1129	1.5	5-cfs	1129pa7dot	5.00	17.00	116.05	116.43		116.50	0.010703	0.38	0.37	2.25	2.46	7.93	5.46	0.65	0.25
1129	1.5	5-cfs	1129Ex(dot)	5.00	17.00	116.05	116.44		116.50	0.010445	0.39	0.31	1.99	2.51	7.98	7.98	0.63	0.20
1129	1.5	10-cfs	1129pa7dot	10.00	17.00	116.05	116.58		116.71	0.013208	0.53	0.51	3.12	3.67	8.90	5.46	0.77	0.42
1129	1.5	10-cfs	1129Ex(dot)	10.00	17.00	116.05	116.59		116.70	0.012378	0.54	0.42	2.63	3.80	9.01	9.01	0.71	0.32
1129	1.5	Fish Psg 0.4*Q2	1129pa7dot	29.00	17.00	116.05	116.91	116.91	117.24	0.017815	0.86	0.84	5.05	6.99	11.14	5.46	0.97	0.94
1129	1.5	Fish Psg 0.4*Q2	1129Ex(dot)	29.00	17.00	116.05	116.96		117.19	0.014518	0.91	0.66	3.82	7.59	11.50	11.50	0.83	0.59
1129	1.5	50-cfs	1129pa7dot	50.00	17.00	116.05	117.22	117.22	117.66	0.015979	1.17	1.16	5.91	10.82	13.26	5.46	0.97	1.15
1129	1.5	50-cfs	1129Ex(dot)	50.00	17.00	116.05	117.24	117.15	117.56	0.015144	1.19	0.83	4.52	11.05	13.37	13.37	0.88	0.76
1129	1.5	2-Yr	1129pa7dot	73.00	17.00	116.05	117.50	117.50	118.01	0.014891	1.45	1.43	6.58	14.71	15.11	5.46	0.97	1.33
1129	1.5	2-Yr	1129Ex(dot)	73.00	17.00	116.05	117.49	117.40	117.88	0.014992	1.44	0.97	5.00	14.60	15.06	15.06	0.90	0.88
1129	1.5	5-Yr	1129pa7dot	109.00	17.00	116.05	117.85	117.85	118.46	0.013863	1.80	1.78	7.35	20.44	17.48	5.46	0.97	1.54
1129	1.5	5-Yr	1129Ex(dot)	109.00	17.00	116.05	117.80	117.72	118.28	0.014962	1.75	1.14	5.57	19.58	17.15	17.15	0.92	1.04
1129	1.5	10-Yr	1129pa7dot	135.00	17.00	116.05	118.05	118.05	118.74	0.013736	2.00	1.99	7.86	24.15	18.91	5.46	0.98	1.70
1129	1.5	10-Yr	1129Ex(dot)	135.00	17.00	116.05	117.99	117.91	118.52	0.014893	1.94	1.25	5.88	22.96	18.42	18.42	0.93	1.12
1129	1.5	25-Yr	1129pa7dot	170.00	17.00	116.05	118.32	118.32	119.06	0.013114	2.27	2.25	8.35	29.42	20.96	5.46	0.98	1.84
1129	1.5	25-Yr	1129Ex(dot)	170.00	17.00	116.05	118.18	118.13	118.82	0.015079	2.13	1.39	6.37	26.73	19.94	19.13	0.95	1.27
1129	1.5	50-Yr	1129pa7dot	198.00	17.00	116.05	118.53	118.53	119.30	0.012268	2.48	2.46	8.57	34.02	23.46	5.46	0.96	1.89
1129	1.5	50-Yr	1129Ex(dot)	198.00	17.00	116.05	118.33	118.29	119.03	0.015067	2.28	1.50	6.70	29.74	21.08	19.62	0.96	1.37
1129	1.5	100-Yr	1129pa7dot	227.00	17.00	116.05	118.62	118.62	119.52	0.013876	2.57	2.55	9.34	36.27	27.08	5.46	1.03	2.21
1129	1.5	100-Yr	1129Ex(dot)	227.00	17.00	116.05	118.48	118.45	119.23	0.014943	2.43	1.61	6.99	32.89	22.21	20.11	0.97	1.46
1129	2	5-cfs	1129Ex(dot)	5.00	24.00	115.80	116.50		116.55	0.004119	0.70	0.62	1.86	3.84	12.33	3.12	0.42	0.14
1129	2	10-cfs	1129Ex(dot)	10.00	24.00	115.80	116.70		116.75	0.004336	0.90	0.81	2.28	6.26	12.90	3.12	0.45	0.20
1129	2	Fish Psg 0.4*Q2	1129Ex(dot)	29.00	24.00	115.80	117.15		117.25	0.004938	1.35	1.26	3.27	12.40	14.25	3.12	0.51	0.35
1129	2	50-cfs	1129Ex(dot)	50.00	24.00	115.80	117.47		117.63	0.005594	1.67	1.59	4.06	17.20	15.22	3.12	0.57	0.50
1129	2	2-Yr	1129Ex(dot)	73.00	24.00	115.80	117.74		117.96	0.006305	1.94	1.86	4.78	21.39	16.02	3.12	0.62	0.66
1129	2	5-Yr	1129Ex(dot)	109.00	24.00	115.80	118.05		118.37	0.007581	2.25	2.16	5.81	26.45	16.94	3.12	0.70	0.93
1129	2	10-Yr	1129Ex(dot)	135.00	24.00	115.80	118.22		118.62	0.008562	2.42	2.34	6.50	29.41	17.45	3.12	0.75	1.14
1129	2	25-Yr	1129Ex(dot)	170.00	24.00	115.80	118.39		118.91	0.010396	2.59	2.51	7.50	32.42	18.75	3.12	0.83	1.48
1129	2	50-Yr	1129Ex(dot)	198.00	24.00	115.80	118.46		119.12	0.012679	2.66	2.58	8.44	33.82	19.92	3.12	0.93	1.86
1129	2	100-Yr	1129Ex(dot)	227.00	24.00	115.80	118.55	118.29	119.34	0.014591	2.75	2.67	9.26	35.66	21.37	3.12	1.00	2.21
1129	5		Culvert															
1129	9	5-cfs	1129pa7dot	5.00	112.00	120.11	120.74	120.74	120.87	0.025093	0.63	0.30	2.95	1.76	8.48	5.61	0.95	0.46
1129	9	5-cfs	1129Ex(dot)	5.00	112.00	120.11	121.10	120.74	121.11	0.000834	0.99	0.60	0.85	8.33	24.39	6.63	0.19	0.03
1129	9	10-cfs	1129pa7dot	10.00	112.00	120.11	120.91	120.91	121.05	0.016991	0.80	0.44	3.13	4.14	18.24	6.23	0.83	0.45
1129	9	10-cfs	1129Ex(dot)	10.00	112.00	120.11	121.63	120.91	121.63	0.000196	1.52	1.12	0.63	21.74	26.38	6.63	0.10	0.01
1129	9	Fish Psg 0.4*Q2	1129pa7dot	29.00	112.00	120.11	121.44	121.18	121.50	0.003673	1.33	0.93	2.41	16.71	25.65	6.63	0.44	0.21
1129	9	Fish Psg 0.4*Q2	1129Ex(dot)	29.00	112.00	120.11	123.05	121.18	123.05	0.000065	2.94	2.54	0.63	63.26	31.93	6.63	0.07	0.01
1129	9	50-cfs	1129pa7dot	50.00	112.00	120.11	122.13	121.34	122.16	0.001104	2.02	1.91	35.49	28.57	6.63	6.63	0.26	0.11
1129	9	50-cfs	1129Ex(dot)	50.00	112.00	120.11	124.42	121.34	124.42	0.000039	4.31	3.91	0.64	110.44	36.94	6.63	0.06	0.01
1129	9	2-Yr	1129pa7dot	73.00	112.00	120.11	122.76	121.48	122.79	0.000655	2.65	2.25	1.83	54.24	30.87	6.63	0.21	0.09
1129	9	2-Yr	1129Ex(dot)	73.00	112.00	120.11	127.37	121.48	127.37	0.000010	7.26	6.86	0.48	226.31	39.55	6.63	0.03	0.00

HEC-RAS River: 1129 Reach: 1129 (Continued)

Reach	River Sta	Profile	Plan	Q Total (cfs)	Cum Ch Len (ft)	Min Ch El (ft)	W.S. Elev (ft)	Crit W.S. (ft)	E.G. Elev (ft)	E.G. Slope (ft/ft)	Max Chl Dpth (ft)	Hydr Depth C (ft)	Vel Chnl (ft/s)	Flow Area (sq ft)	Top Width (ft)	Top W Chnl (ft)	Froude # Chl	Shear Chan (lb/sq ft)
1129	9	5-Yr	1129pa7dot	109.00	112.00	120.11	123.78	121.67	123.81	0.000356	3.67	3.27	1.73	87.63	34.61	6.63	0.17	0.07
1129	9	5-Yr	1129Ex(dot)	109.00	112.00	120.11	129.31	121.67	129.31	0.000010	9.20	8.80	0.55	302.86	39.55	6.63	0.03	0.01
1129	9	10-Yr	1129pa7dot	135.00	112.00	120.11	124.49	121.81	124.51	0.000263	4.38	3.98	1.70	113.06	37.20	6.63	0.15	0.06
1129	9	10-Yr	1129Ex(dot)	135.00	112.00	120.11	129.57	121.81	129.57	0.000013	9.46	9.07	0.66	313.33	39.55	6.63	0.04	0.01
1129	9	25-Yr	1129pa7dot	170.00	112.00	120.11	125.33	121.97	125.35	0.000203	5.22	4.82	1.69	145.50	39.55	6.63	0.14	0.06
1129	9	25-Yr	1129Ex(dot)	170.00	112.00	120.11	129.76	121.97	129.77	0.000020	9.65	9.26	0.81	320.99	39.55	6.63	0.05	0.01
1129	9	50-Yr	1129pa7dot	198.00	112.00	120.11	126.09	122.09	126.11	0.000158	5.98	5.58	1.65	175.62	39.55	6.63	0.12	0.05
1129	9	50-Yr	1129Ex(dot)	198.00	112.00	120.11	129.93	122.09	129.93	0.000025	9.82	9.42	0.93	327.38	39.55	6.63	0.05	0.01
1129	9	100-Yr	1129pa7dot	227.00	112.00	120.11	126.76	122.21	126.78	0.000137	6.64	6.25	1.65	202.00	39.55	6.63	0.12	0.05
1129	9	100-Yr	1129Ex(dot)	227.00	112.00	120.11	130.08	122.21	130.09	0.000031	9.97	9.57	1.05	333.41	39.55	6.63	0.06	0.02
1129	10	5-cfs	1129pa7dot	5.00	168.00	122.29	122.92	122.92	123.05	0.025081	0.63	0.30	2.95	1.76	8.48	5.61	0.95	0.46
1129	10	5-cfs	1129Ex(dot)	5.00	168.00	122.29	122.88	122.92	123.06	0.038451	0.59	0.27	3.40	1.48	6.39	5.48	1.16	0.63
1129	10	10-cfs	1129pa7dot	10.00	168.00	122.29	123.09	123.09	123.23	0.016991	0.80	0.44	3.13	4.14	18.24	6.23	0.83	0.45
1129	10	10-cfs	1129Ex(dot)	10.00	168.00	122.29	123.01	123.09	123.27	0.038429	0.72	0.37	4.23	2.78	13.58	5.93	1.22	0.87
1129	10	Fish Psg 0.4*Q2	1129pa7dot	29.00	168.00	122.29	123.36	123.36	123.53	0.016063	1.07	0.67	4.04	10.15	24.67	6.63	0.87	0.65
1129	10	Fish Psg 0.4*Q2	1129Ex(dot)	29.00	168.00	122.29	123.24	123.36	123.60	0.038412	0.95	0.56	5.54	7.43	24.25	6.63	1.31	1.30
1129	10	50-cfs	1129pa7dot	50.00	168.00	122.29	123.52	123.52	123.77	0.017505	1.23	0.84	4.89	14.28	25.29	6.63	0.94	0.89
1129	10	50-cfs	1129Ex(dot)	50.00	168.00	122.29	124.40	123.52	124.43	0.000882	2.11	1.72	1.77	38.22	28.91	6.63	0.24	0.09
1129	10	2-Yr	1129pa7dot	73.00	168.00	122.29	123.66	123.66	123.99	0.019299	1.37	0.97	5.68	17.78	25.81	6.63	1.01	1.14
1129	10	2-Yr	1129Ex(dot)	73.00	168.00	122.29	127.37	123.66	127.37	0.000042	5.08	4.68	0.75	140.04	39.55	6.63	0.06	0.01
1129	10	5-Yr	1129pa7dot	109.00	168.00	122.29	123.85	123.85	124.28	0.019781	1.56	1.17	6.50	22.95	26.56	6.63	1.06	1.40
1129	10	5-Yr	1129Ex(dot)	109.00	168.00	122.29	129.30	123.86	129.31	0.000026	7.01	6.62	0.74	216.61	39.55	6.63	0.05	0.01
1129	10	10-Yr	1129pa7dot	135.00	168.00	122.29	124.38		124.62	0.006729	2.09	1.70	4.86	37.65	28.84	6.63	0.66	0.69
1129	10	10-Yr	1129Ex(dot)	135.00	168.00	122.29	129.57	123.99	129.58	0.000034	7.28	6.88	0.88	227.07	39.55	6.63	0.06	0.01
1129	10	25-Yr	1129pa7dot	170.00	168.00	122.29	125.28		125.41	0.002067	2.99	2.60	3.58	65.08	32.13	6.63	0.39	0.33
1129	10	25-Yr	1129Ex(dot)	170.00	168.00	122.29	129.76	124.15	129.77	0.000049	7.47	7.08	1.08	234.72	39.55	6.63	0.07	0.02
1129	10	50-Yr	1129pa7dot	198.00	168.00	122.29	126.06		126.15	0.001046	3.77	3.38	3.03	91.21	34.98	6.63	0.29	0.21
1129	10	50-Yr	1129Ex(dot)	198.00	168.00	122.29	129.92	124.27	129.94	0.000062	7.63	7.24	1.22	241.08	39.55	6.63	0.08	0.03
1129	10	100-Yr	1129pa7dot	227.00	168.00	122.29	126.74		126.81	0.000697	4.45	4.05	2.79	115.62	37.45	6.63	0.24	0.17
1129	10	100-Yr	1129Ex(dot)	227.00	168.00	122.29	130.08	124.39	130.09	0.000075	7.79	7.39	1.37	247.10	39.55	6.63	0.09	0.03

23.5.3 Hydraulic Output – Small Fish Pipes

2009 Alignment Station: 228+95

1 2006 S&HI Station 252+00 Existing conditions

CURRENT DATE: 08-17-2006
 CURRENT TIME: 11:28:57

FILE DATE: 08-17-2006
 FILE NAME: 252-EX

FHWA CULVERT ANALYSIS
 HY-8, VERSION 6.1

C	SITE DATA			CULVERT SHAPE, MATERIAL, INLET					
U	L	INLET	OUTLET	CULVERT	BARRELS				
V	ELEV.	ELEV.	LENGTH	SHAPE	SPAN	RISE	MANNING	INLET	
NO.	(ft)	(ft)	(ft)	MATERIAL	(ft)	(ft)	n	TYPE	
1	22.29	21.43	70.01	1 CSP	2.00	2.00	.024	CONVENTIONAL	
2									
3									
4									
5									
6									

SUMMARY OF CULVERT FLOWS (cfs) FILE: 252-EX DATE: 08-17-2006

ELEV (ft)	TOTAL	1	2	3	4	5	6	ROADWAY	ITR
22.29	0	0	0	0	0	0	0	0	1
23.31	3	3	0	0	0	0	0	0	1
23.6	5	5	0	0	0	0	0	0	1
24.12	9	9	0	0	0	0	0	0	1
24.45	12	12	0	0	0	0	0	0	1
24.81	15	15	0	0	0	0	0	0	1
25.44	18	18	0	0	0	0	0	0	1
26.56	21	21	0	0	0	0	0	0	1
26.81	24	21.6	0	0	0	0	0	2.22	9
26.89	27	21.9	0	0	0	0	0	4.96	5
26.96	30	22.1	0	0	0	0	0	7.71	4
26.7	21.4	21.4	0	0	0	0	0	0 OVERTOPP	ING

SUMMARY OF ITERATIVE SOLUTION ERRORS FILE: 252-EX DATE: 08-17-2006

HEAD	HEAD	TOTAL	FLOW	% FLOW
ELEV (ft)	ERROR (ft)	FLOW (cfs)	ERROR (c)	ERROR
22.29	0	0	0	0
23.31	0	3	0	0
23.6	0	5	0	0
24.12	0	9	0	0
24.45	0	12	0	0
24.81	0	15	0	0

25.44	0	18	0	0
26.56	0	21	0	0
26.81	-0.004	24	0.13	0.54
26.89	-0.004	27	0.15	0.56
26.96	-0.007	30	0.21	0.7

<1> TOLERANCE (ft) = 0.010

<2> TOLERANCE (%) = 1.000

2

CURRENT DATE: 08-17-2006
CURRENT TIME: 11:28:57

FILE DATE: 08-17-2006
FILE NAME: 252-EX

PERFORMANCE CURVE FOR CULVERT 1 - 1(2.00 (ft) BY 2.00 (ft)) CSP

DIS-CHARGE FLOW (cfs)	HEAD-WATER ELEV. (ft)	INLET CONTROL DEPTH (ft)	OUTLET CONTROL DEPTH (ft)	FLOW TYPE <F4>	NORMAL DEPTH (ft)	CRIT. DEPTH (ft)	OUTLET DEPTH (ft)	TW DEPTH (ft)	OUTLET VEL. (fps)
0	22.29	0	0	0 0-NF	0	0	0	-0.8	0
3	23.31	0.89	1.02	2-M2c	0.63	0.6	0.6	0.32	3.75
5	23.6	1.18	1.31	2-M2c	0.84	0.79	0.79	0.44	4.36
9	24.12	1.69	1.83	2-M2c	1.19	1.07	1.07	0.57	5.28
12	24.45	2.08	2.16	2-M2c	1.46	1.24	1.24	0.64	5.85
15	24.81	2.52	2.52	2-M2c	2	1.4	1.4	0.69	6.41
18	25.44	3.04	3.15	2-M2c	2	1.52	1.52	0.74	7.03
21	26.56	3.66	4.27	2-M2c	2	1.63	1.63	0.78	7.63
21.65	26.8	3.81	4.51	2-M2c	2	1.65	1.65	0.82	7.82
21.89	26.89	3.86	4.6	2-M2c	2	1.66	1.66	0.86	7.88
22.08	26.95	3.91	4.66	2-M2c	2	1.67	1.67	0.89	7.92

El. inlet face invert 22.29 ft El. outlet invert 21.43 ft
El. inlet throat invert 0.00 ft El. inlet crest 0.00 ft

***** SITE DATA ***** CULVERT INVERT *****

INLET STATION 0.00 ft
INLET ELEVATION 22.29 ft
OUTLET STATION 70.00 ft
OUTLET ELEVATION 21.43 ft
NUMBER OF BARRELS 1
SLOPE (V/H) 0.0123
CULVERT LENGTH ALONG SLOPE 70.01 ft

***** CULVERT DATA SUMMARY *****

BARREL SHAPE CIRCULAR
BARREL DIAMETER 2.00 ft
BARREL MATERIAL CORRUGATED STEEL
BARREL MANNING'S n 0.024
INLET TYPE CONVENTIONAL

INLET EDGE AND WALL THIN EDGE PROJECTING
INLET DEPRESSION NONE

3

CURRENT DATE: 08-17-2006
CURRENT TIME: 11:28:57

FILE DATE: 08-17-2006
FILE NAME: 252-EX

TAILWATER

***** USER DEFINED CHANNEL CROSS-SECTION

FILE NAME: 252-TW

MAIN CHANNEL AND LT & RT OVER BANKS

FILE DATE: 08-16-2006

LEFT CHANNEL BOUNDARY 2
RIGHT CHANNEL BOUNDARY 5
MANNING n LEFT OVER BANK 0.050
MANNING n MAIN CHANNEL 0.038
MANNING n RIGHT OVER BANK 0.050
SLOPE OF CHANNEL 0.0020 ft/ft

CROSS-SECTION	X	Y
COORD. NO.	(ft)	(ft)
1	0.00	23.00
2	100.00	21.63
3	100.50	20.63
4	102.50	20.63
5	103.00	21.63
6	203.00	23.00

***** UNIFORM FLOW RATING CURVE FOR DOWNSTREAM CHANNEL

FLOW	W.S.E.	FROUDE	DEPTH	VEL.	SHEAR
(cfs)	(ft)	NUMBER	(ft)	(f/s)	(psf)
0.00	20.63	0.000	-0.80	0.00	0.00
3.00	21.75	0.243	0.32	1.34	0.08
5.00	21.87	0.248	0.44	1.45	0.09
9.00	22.00	0.253	0.57	1.57	0.11
12.00	22.07	0.255	0.64	1.63	0.11
15.00	22.12	0.257	0.69	1.68	0.12
18.00	22.17	0.258	0.74	1.72	0.12
21.00	22.21	0.260	0.78	1.75	0.13
24.00	22.25	0.261	0.82	1.78	0.13
27.00	22.29	0.262	0.86	1.81	0.13
30.00	22.32	0.263	0.89	1.84	0.14

Note: Shear stress was calculated using R.

ROADWAY OVERTOPPING DATA

ROADWAY SURFACE	PAVED
EMBANKMENT TOP WIDTH	22.00 ft
CREST LENGTH	20.00 ft
OVERTOPPING CREST ELEVATION	26.70 ft

2009 Alignment Station: 228+95

2006 S&H Station 252+00 Tier 2 FISH PASS design

Analysis of Existing conditions

no baffles

Juvenile Coho

C:\Client\ALASKA-1\ADFGFI-1\fishpass.exe

Help Print Status Backwater Inlet CalcMode cOrrugations

Weak Swimming Fish Passage

Length	Culvert	Slope	Manning n	Q	Culvert	Depth	Outlet
Fish (mm)	(ft)	(%)	Wall Bed	(cfs)	Diam. (ft)	Bed (ft)	(ft)
96	70	1.2	.024 0	3	2	0	.7

--- Fish Passage ---

Allowable Uel.	Min. Flow Depth	Possible Power	Outlet	Inlet
4.4 ft/sec	0.54 ft	0.42 watts	0.77	0.77

Calculated Fish Parameters Possible Energy (joules)

Depth (ft)	Normal Flow	Critical Flow
0.64	0.64	0.60

Aug., cross-section, water velocity (ft/sec)

Depth (ft)	Normal Flow	Critical Flow
3.44	3.44	3.75

Fish power required in outlet zone (watts)

0.21

Fish energy required in outlet zone (joules)

0.43

Fish power required at inlet (watts)

0.21

Fish energy required at inlet (joules)

0.43

Acceptable Design

Alt = Menu <F1 = Current Field Help> <Esc = Exit>

Adult Coho

600-mm

C:\Client\ALASKA-1\ADFGFI-1\fishpass.exe

Help Print Status Backwater Inlet CalcMode cOrrugations

Weak Swimming Fish Passage

Length	Culvert	Slope	Manning n	Q	Culvert	Depth	Outlet
Fish (mm)	(ft)	(%)	Wall Bed	(cfs)	Diam. (ft)	Bed (ft)	(ft)
600	70	1.2	.024 0	3	2	0	.7

--- Fish Passage ---

Allowable Uel.	Min. Flow Depth	Possible Power	Outlet	Inlet
6.0 ft/sec	0.43 ft	38.11 watts	187.50	187.50

Calculated Fish Parameters Possible Energy (joules)

Depth (ft)	Normal Flow	Critical Flow
0.64	0.64	0.60

Aug., cross-section, water velocity (ft/sec)

Depth (ft)	Normal Flow	Critical Flow
3.44	3.44	3.75

Fish power required in outlet zone (watts)

9.84

Fish energy required in outlet zone (joules)

19.68

Fish power required at inlet (watts)

9.84

Fish energy required at inlet (joules)

19.68

Acceptable Design

Alt = Menu <F1 = Current Field Help> <Esc = Exit>

Adult Coho

600 1.57 942

Note: L * 1.57 converts swimming ability to 'equivalent' grayling

Assume depth based on actual body size of 600-mm fish above

C:\Client\ALASKA-1\ADFGFI-1\fishpass.exe

Help Print Status Backwater Inlet CalcMode cOrrugations

Weak Swimming Fish Passage

Length	Culvert	Slope	Manning n	Q	Culvert	Depth	Outlet
Fish (mm)	(ft)	(%)	Wall Bed	(cfs)	Diam. (ft)	Bed (ft)	(ft)
942	70	1.2	.024 0	3	2	0	.7

--- Fish Passage ---

Allowable Uel.	Min. Flow Depth	Possible Power	Outlet	Inlet
6.4 ft/sec	0.41 ft	115.59 watts	725.60	

Calculated Fish Parameters Possible Energy (joules)

Depth (ft)	Normal Flow	Critical Flow
0.64	0.64	0.60

Aug., cross-section, water velocity (ft/sec)

Depth (ft)	Normal Flow	Critical Flow
3.44	3.44	3.75

Fish power required in outlet zone (watts)

--

Fish energy required in outlet zone (joules)

--

Fish power required at inlet (watts)

--

Fish energy required at inlet (joules)

--

Normal Depth too shallow

Alt = Menu <F1 = Current Field Help> <Esc = Exit>

2009 Alignment Station: 240+38

1 2006 S&HI Station 263+50 Existing conditions

CURRENT DATE: 08-17-2006
CURRENT TIME: 12:26:58

FILE DATE: 08-17-2006
FILE NAME: 26350

FHWA CULVERT ANALYSIS
HY-8, VERSION 6.1

C	SITE DATA			CULVERT SHAPE, MATERIAL, INLET					
U	L	INLET	OUTLET	CULVERT	BARRELS				
V	ELEV.	ELEV.	LENGTH	SHAPE	SPAN	RISE	MANNING	INLET	
NO.	(ft)	(ft)	(ft)	MATERIAL	(ft)	(ft)	n	TYPE	
1	22.66	21.49	59.01	1 CSP	2.00	2.00	.024	CONVENTIONAL	
2									
3									
4									
5									
6									

SUMMARY OF CULVERT FLOWS (cfs) FILE: 26350 DATE: 08-17-2006

ELEV (ft)	TOTAL	1	2	3	4	5	6	ROADWAY	ITR
22.66	0	0	0	0	0	0	0	0	1
23.83	5	5	0	0	0	0	0	0	1
24.74	12	12	0	0	0	0	0	0	1
25.69	18	18	0	0	0	0	0	0	1
27.32	24	24	0	0	0	0	0	0	1
28.95	30	28.3	0	0	0	0	0	1.54	8
29.19	36	28.9	0	0	0	0	0	6.96	4
29.36	42	29.3	0	0	0	0	0	12.34	3
29.52	48	29.7	0	0	0	0	0	18.02	3
29.66	54	30	0	0	0	0	0	23.83	3
29.79	60	30.2	0	0	0	0	0	29.57	3
28.81	28	28	0	0	0	0	0	0 OVERTOPP	ING

SUMMARY OF ITERATIVE SOLUTION ERRORS FILE: 26350 DATE: 08-17-2006

HEAD	HEAD	TOTAL	FLOW	% FLOW
ELEV (ft)	ERROR (ft)	FLOW (cfs)	ERROR (cfs)	ERROR
22.66	0.000	0.00	0.00	0.00
23.83	0.000	5.00	0.00	0.00
24.74	0.000	12.00	0.00	0.00
25.69	0.000	18.00	0.00	0.00
27.32	0.000	24.00	0.00	0.00
28.95	-0.005	30.00	0.14	0.47

29.19	-0.005	36.00	0.19	0.53
29.36	-0.008	42.00	0.39	0.93
29.52	-0.006	48.00	0.32	0.67
29.66	-0.003	54.00	0.17	0.31
29.79	-0.004	60.00	0.20	0.33

<1> TOLERANCE (ft) = 0.010

<2> TOLERANCE (%) = 1.000

2

CURRENT DATE: 08-17-2006
CURRENT TIME: 12:26:58

FILE DATE: 08-17-2006
FILE NAME: 26350

PERFORMANCE CURVE FOR CULVERT 1 - 1(2.00 (ft) BY 2.00 (ft)) CSP

DIS-CHARGE FLOW (cfs)	HEAD-WATER ELEV. (ft)	INLET CONTROL DEPTH (ft)	OUTLET CONTROL DEPTH (ft)	FLOW TYPE <F4>	NORMAL DEPTH (ft)	CRIT. DEPTH (ft)	OUTLET DEPTH (ft)	TW DEPTH (ft)	OUTLET VEL. (fps)
0	22.66	0	0	0-NF	0	0	0	0	0.16
5	23.83	1.17	1.17	1-S2n	0.73	0.79	0.73	1.31	4.84
12	24.74	2.08	2.08	5-S2n	1.23	1.24	1.14	1.52	6.48
18	25.69	3.03	2.89	3-M2t	1.75	1.52	1.62	1.62	6.6
24	27.32	4.38	4.66	2-M2c	2	1.72	1.72	1.69	8.37
28.32	28.97	5.66	6.31	2-M2c	2	1.85	1.85	1.76	9.38
28.85	29.19	5.83	6.53	2-M2c	2	1.87	1.87	1.81	9.52
29.28	29.36	5.98	6.7	2-M2c	2	1.88	1.88	1.86	9.62
29.66	29.52	6.11	6.86	3-M2t	2	1.89	1.9	1.9	9.7
30	29.7	6.22	7.04	3-M2t	2	1.9	1.94	1.94	9.71
30.24	29.8	6.31	7.14	3-M2t	2	1.91	1.98	1.98	9.69

El. inlet face invert 22.66 ft El. outlet invert 21.49 ft
El. inlet throat invert 0.00 ft El. inlet crest 0.00 ft

***** SITE DATA ***** CULVERT INVERT *****

INLET STATION 0.00 ft
INLET ELEVATION 22.66 ft
OUTLET STATION 59.00 ft
OUTLET ELEVATION 21.49 ft
NUMBER OF BARRELS 1
SLOPE (V/H) 0.0198
CULVERT LENGTH ALONG SLOPE 59.01 ft

***** CULVERT DATA SUMMARY *****

BARREL SHAPE CIRCULAR
BARREL DIAMETER 2.00 ft
BARREL MATERIAL CORRUGATED STEEL
BARREL MANNING'S n 0.024
INLET TYPE CONVENTIONAL

INLET EDGE AND WALL THIN EDGE PROJECTING
INLET DEPRESSION NONE

3

CURRENT DATE: 08-17-2006
CURRENT TIME: 12:26:58

FILE DATE: 08-17-2006
FILE NAME: 26350

TAILWATER

***** USER DEFINED CHANNEL CROSS-SECTION

FILE NAME: 263-TW

MAIN CHANNEL AND LT & RT OVER BANKS

FILE DATE: 08-17-2006

LEFT CHANNEL BOUNDARY 2
RIGHT CHANNEL BOUNDARY 5
MANNING n LEFT OVER BANK 0.050
MANNING n MAIN CHANNEL 0.038
MANNING n RIGHT OVER BANK 0.050
SLOPE OF CHANNEL 0.0036 ft/ft

CROSS-SECTION	X	Y
COORD. NO.	(ft)	(ft)
1	0.00	24.00
2	100.00	22.65
3	100.50	21.65
4	102.50	21.65
5	103.00	22.65
6	203.00	24.00

***** UNIFORM FLOW RATING CURVE FOR DOWNSTREAM CHANNEL

FLOW	W.S.E.	FROUDE	DEPTH	VEL.	SHEAR
(cfs)	(ft)	NUMBER	(ft)	(f/s)	(psf)
0.00	21.65	0.000	0.16	0.00	0.00
5.00	22.80	0.328	1.31	1.85	0.16
12.00	23.01	0.338	1.52	2.10	0.19
18.00	23.11	0.343	1.62	2.21	0.21
24.00	23.18	0.346	1.69	2.30	0.22
30.00	23.25	0.349	1.76	2.37	0.23
36.00	23.30	0.351	1.81	2.42	0.24
42.00	23.35	0.353	1.86	2.47	0.24
48.00	23.39	0.354	1.90	2.52	0.25
54.00	23.43	0.356	1.94	2.56	0.26
60.00	23.47	0.357	1.98	2.60	0.26

Note: Shear stress was calculated using R.

ROADWAY OVERTOPPING DATA

ROADWAY SURFACE	PAVED
EMBANKMENT TOP WIDTH	22.00 ft
CREST LENGTH	10.00 ft
OVERTOPPING CREST ELEVATION	28.81 ft

2009 Alignment Station: 240+38

2006 S&H Station 263+50 Tier 2 FISH PASS design

Analysis of Existing conditions

no baffles

Juvenile Coho

C:\Client\ALASKA-1\ADFGFI-1\fishpass.exe

Help Print Status Backwater Inlet CalcMode cOrrugations

Weak Swimming Fish Passage

Length	Culvert	Slope	Manning n	0	Culvert	Depth
Fish (mm)	(ft)	(%)	Wall	Bed (cfs)	Diam. (ft)	Bed (ft) Outlet (ft)
96	66	1.4	.024	0	3	2 0 .65

--- Fish Passage ---

Allowable Uel.	Min. Flow	Depth	Possible Power	Outlet	Inlet
4.4 ft/sec		0.54 ft	0.42 watts	0.77	0.77

Calculated Fish Parameters

Depth (ft)	Normal Flow	Critical Flow
0.62	0.62	0.60

Aug., cross-section, water velocity (ft/sec)

Normal Flow	Critical Flow
3.64	3.75

Fish power required in outlet zone (watts)

Fish energy required in outlet zone (joules)

Fish power required at inlet (watts)

Fish energy required at inlet (joules)

0.23

0.46

Acceptable Design

Alt = Menu <F1 = Current Field Help> <Esc = Exit>

Adult Coho

600-mm Adult Coho

C:\Client\ALASKA-1\ADFGFI-1\fishpass.exe

Help Print Status Backwater Inlet CalcMode cOrrugations

Weak Swimming Fish Passage

Length	Culvert	Slope	Manning n	0	Culvert	Depth
Fish (mm)	(ft)	(%)	Wall	Bed (cfs)	Diam. (ft)	Bed (ft) Outlet (ft)
600	66	1.4	.024	0	3	2 0 .65

--- Fish Passage ---

Allowable Uel.	Min. Flow	Depth	Possible Power	Outlet	Inlet
6.0 ft/sec		0.43 ft	38.11 watts	187.50	187.50

Calculated Fish Parameters

Depth (ft)	Normal Flow	Critical Flow
0.62	0.62	0.60

Aug., cross-section, water velocity (ft/sec)

Normal Flow	Critical Flow
3.64	3.75

Fish power required in outlet zone (watts)

Fish energy required in outlet zone (joules)

Fish power required at inlet (watts)

Fish energy required at inlet (joules)

10.69

21.39

Acceptable Design

Alt = Menu <F1 = Current Field Help> <Esc = Exit>

Adult Coho

600 1.57 942

Note: $L * 1.57$ converts swimming ability to 'equivalent' grayling

Assume depth based on actual body size of 600-mm fish above

C:\Client\ALASKA-1\ADFGFI-1\fishpass.exe

Help Print Status Backwater Inlet CalcMode cOrrugations

Weak Swimming Fish Passage

Length	Culvert	Slope	Manning n	0	Culvert	Depth
Fish (mm)	(ft)	(%)	Wall	Bed (cfs)	Diam. (ft)	Bed (ft) Outlet (ft)
942	66	1.4	.024	0	3	2 0 .65

--- Fish Passage ---

Allowable Uel.	Min. Flow	Depth	Possible Power	Outlet	Inlet
6.3 ft/sec		0.42 ft	115.59 watts	725.60	

Calculated Fish Parameters

Depth (ft)	Normal Flow	Critical Flow
0.62	0.62	0.60

Aug., cross-section, water velocity (ft/sec)

Normal Flow	Critical Flow
3.64	3.75

Fish power required in outlet zone (watts)

Fish energy required in outlet zone (joules)

Fish power required at inlet (watts)

Fish energy required at inlet (joules)

Normal Depth too shallow

Alt = Menu <F1 = Current Field Help> <Esc = Exit>

245+19

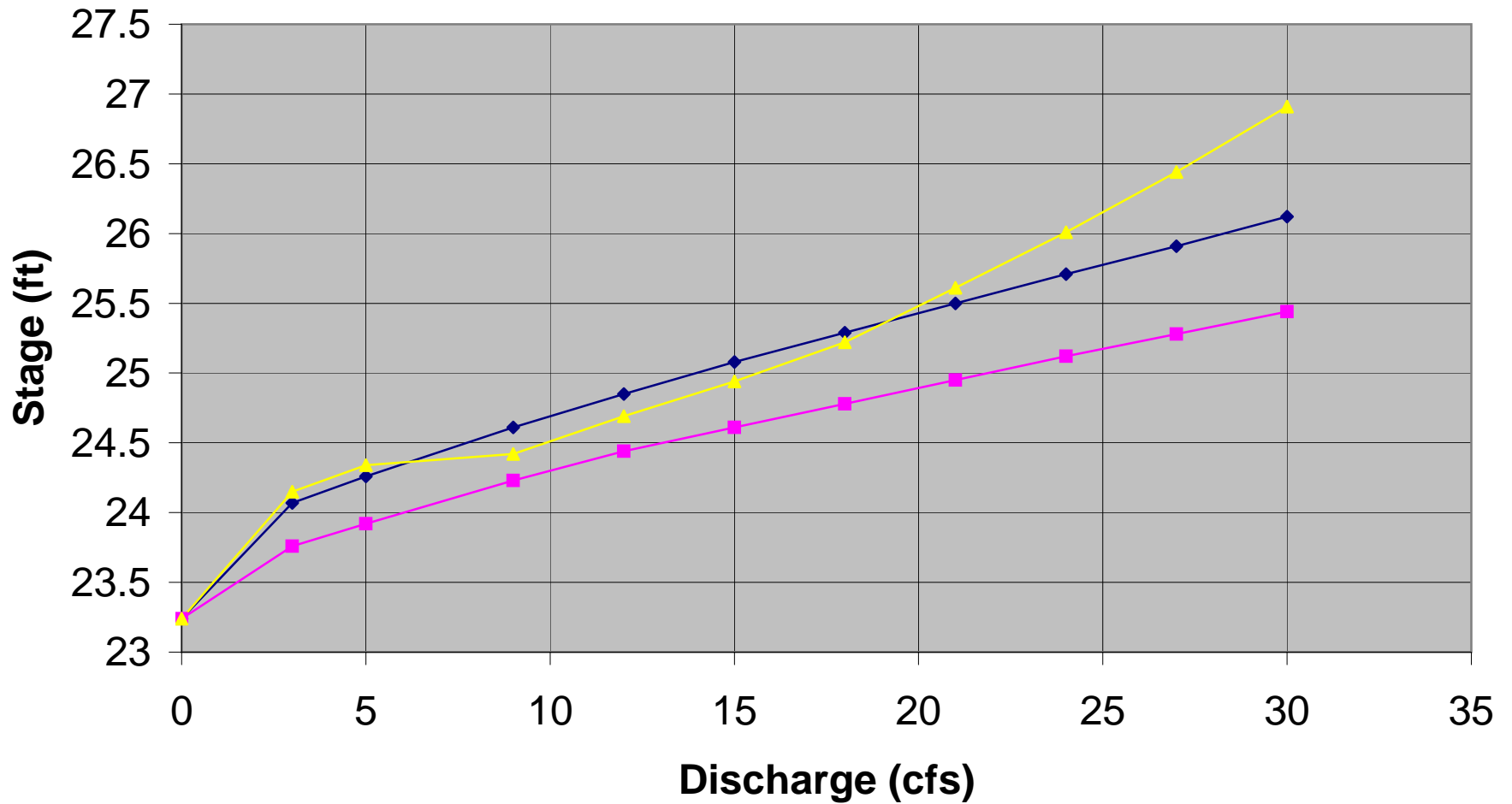

◆ 268+90-ex ■ 4-ft Tier 1 (flat bed) ▲ 3-ft Tier 1 (flat bed)

2009 Alignment Station: 245+19

1 2006 S&HI Station 268+90 Existing conditions

CURRENT DATE: 08-25-2006
CURRENT TIME: 11:17:47

FILE DATE: 08-25-2006
FILE NAME: 26890EX

FHWA CULVERT ANALYSIS
HY-8, VERSION 6.1

C	SITE DATA			CULVERT SHAPE, MATERIAL, INLET						
U	L	INLET	OUTLET	CULVERT	BARRELS					
V	ELEV.	ELEV.	LENGTH	SHAPE	SPAN	RISE	MANNING	INLET		
NO.	(ft)	(ft)	(ft)	MATERIAL	(ft)	(ft)	n	TYPE		
1	23.24	21.71	58.02	1 CSP	3.00	3.00	.024	CONVENTIONAL		
2										
3										
4										
5										
6										

SUMMARY OF CULVERT FLOWS (cfs) FILE: 26890EX DATE: 08-25-2006

ELEV (ft)	TOTAL	1	2	3	4	5	6	ROADWAY	INTR
23.24	0	0	0	0	0	0	0	0	1
24.07	3	3	0	0	0	0	0	0	1
24.26	5	5	0	0	0	0	0	0	1
24.61	9	9	0	0	0	0	0	0	1
24.85	12	12	0	0	0	0	0	0	1
25.08	15	15	0	0	0	0	0	0	1
25.29	18	18	0	0	0	0	0	0	1
25.5	21	21	0	0	0	0	0	0	1
25.71	24	24	0	0	0	0	0	0	1
25.91	27	27	0	0	0	0	0	0	1
26.12	30	30	0	0	0	0	0	0	1
27.64	48.2	48.2	0	0	0	0	0	0	OVERTOPING

SUMMARY OF ITERATIVE SOLUTION ERRORS FILE: 26890EX DATE: 08-25-2006

HEAD ELEV (ft)	HEAD ERROR (ft)	TOTAL FLOW (cfs)	FLOW ERROR (cfs)	% FLOW ERROR
23.24	0.000	0.00	0.00	0.00
24.07	0.000	3.00	0.00	0.00
24.26	0.000	5.00	0.00	0.00
24.61	0.000	9.00	0.00	0.00
24.85	0.000	12.00	0.00	0.00
25.08	0.000	15.00	0.00	0.00
25.29	0.000	18.00	0.00	0.00
25.50	0.000	21.00	0.00	0.00
25.71	0.000	24.00	0.00	0.00
25.91	0.000	27.00	0.00	0.00

26.12 0.000 30.00 0.00 0.00

<1> TOLERANCE (ft) = 0.010 <2> TOLERANCE (%) = 1.000

2

CURRENT DATE: 08-25-2006 FILE DATE: 08-25-2006
CURRENT TIME: 11:17:47 FILE NAME: 26890EX

PERFORMANCE CURVE FOR CULVERT 1 - 1(3.00 (ft) BY 3.00 (ft)) CSP

DIS- HEAD- INLET OUTLET
CHARGE WATER CONTROL CONTROL FLOW NORMAL CRIT. OUTLET TW OUTLET TW
FLOW ELEV. DEPTH DEPTH TYPE DEPTH DEPTH DEPTH DEPTH VEL. VEL.
(cfs) (ft) (ft) (ft) <F4> (ft) (ft) (ft) (ft) (fps) (fps)

0.00	23.24	0.00	0.00	0-NF	0.00	0.00	0.00	-0.56	0.00	0.00
3.00	24.07	0.83	0.83	1-S2n	0.44	0.52	0.32	0.33	8.21	1.85
5.00	24.26	1.02	1.02	1-S2n	0.59	0.69	0.49	0.39	6.52	1.96
9.00	24.61	1.37	1.37	1-S2n	0.78	0.94	0.78	0.47	6.09	2.10
12.00	24.85	1.61	1.61	1-S2n	0.92	1.09	0.79	0.52	8.00	2.17
15.00	25.08	1.84	1.84	1-S2n	1.03	1.23	0.93	0.56	8.04	2.23
18.00	25.29	2.05	2.05	1-S2n	1.13	1.35	1.05	0.60	8.13	2.29
21.00	25.50	2.26	2.26	1-S2n	1.24	1.47	1.17	0.63	8.22	2.34
24.00	25.71	2.47	2.47	1-S2n	1.33	1.57	1.27	0.65	8.39	2.38
27.00	25.91	2.67	2.67	1-S2n	1.42	1.67	1.37	0.68	8.56	2.42
30.00	26.12	2.88	2.88	1-S2n	1.52	1.77	1.51	0.70	8.40	2.45

El. inlet face invert 23.24 ft El. outlet invert 21.71 ft
El. inlet throat invert 0.00 ft El. inlet crest 0.00 ft

***** SITE DATA ***** CULVERT INVERT *****

INLET STATION 0.00 ft
INLET ELEVATION 23.24 ft
OUTLET STATION 58.00 ft
OUTLET ELEVATION 21.71 ft
NUMBER OF BARRELS 1
SLOPE (V/H) 0.0264
CULVERT LENGTH ALONG SLOPE 58.02 ft

***** CULVERT DATA SUMMARY *****

BARREL SHAPE CIRCULAR
BARREL DIAMETER 3.00 ft
BARREL MATERIAL CORRUGATED STEEL
BARREL MANNING'S n 0.024
INLET TYPE CONVENTIONAL
INLET EDGE AND WALL THIN EDGE PROJECTING
INLET DEPRESSION NONE

3

CURRENT DATE: 08-25-2006 FILE DATE: 08-25-2006

CURRENT TIME: 11:17:47

FILE NAME: 26890EX

TAILWATER

***** USER DEFINED CHANNEL CROSS-SECTION FILE NAME: 26890TW
 MAIN CHANNEL AND LT & RT OVER BANKS FILE DATE: 08-25-2006
 LEFT CHANNEL BOUNDARY 2
 RIGHT CHANNEL BOUNDARY 5
 MANNING n LEFT OVER BANK 0.050
 MANNING n MAIN CHANNEL 0.038
 MANNING n RIGHT OVER BANK 0.050
 SLOPE OF CHANNEL 0.0053 ft/ft

CROSS-SECTION	X	Y
COORD. NO.	(ft)	(ft)
1	0.00	23.00
2	100.00	21.85
3	100.50	21.15
4	101.50	21.15
5	102.00	21.85
6	202.00	23.00

***** UNIFORM FLOW RATING CURVE FOR DOWNSTREAM CHANNEL

FLOW (cfs)	W.S.E. (ft)	FROUDE NUMBER	DEPTH (ft)	VEL. (f/s)	SHEAR (psf)
0.00	21.15	0.000	-0.56	0.00	0.00
3.00	22.04	0.386	0.33	1.85	0.17
5.00	22.10	0.392	0.39	1.96	0.19
9.00	22.18	0.398	0.47	2.10	0.21
12.00	22.23	0.402	0.52	2.17	0.22
15.00	22.27	0.405	0.56	2.23	0.23
18.00	22.31	0.407	0.60	2.29	0.24
21.00	22.34	0.409	0.63	2.34	0.25
24.00	22.36	0.411	0.65	2.38	0.25
27.00	22.39	0.413	0.68	2.42	0.26
30.00	22.41	0.414	0.70	2.45	0.26

Note: Shear stress was calculated using R.

ROADWAY OVERTOPPING DATA

ROADWAY SURFACE PAVED
 EMBANKMENT TOP WIDTH 24.00 ft
 CREST LENGTH 10.00 ft
 OVERTOPPING CREST ELEVATION 27.64 ft

2009 Alignment Station: 272+40

1 2006 S&HI Station 268+90 Tier 1 fish passage - 4-ft CMP

CURRENT DATE: 08-29-2006
CURRENT TIME: 19:31:05

FILE DATE: 08-29-2006
FILE NAME: 268-TW

FHWA CULVERT ANALYSIS
HY-8, VERSION 6.1

C SITE DATA CULVERT SHAPE, MATERIAL, INLET
U
L INLET OUTLET CULVERT BARRELS
V ELEV. ELEV. LENGTH SHAPE SPAN RISE MANNING INLET
NO. (ft) (ft) (ft) MATERIAL (ft) (ft) n TYPE
1 23.24 21.71 58.02 1ICMP 4.00 2.40 .024 CONVENTIONAL
2
3
4
5
6

SUMMARY OF CULVERT FLOWS (cfs) FILE: 268-TW DATE: 08-29-2006

ELEV (ft)	TOTAL	1	2	3	4	5	6 ROADWAY	ITR
23.24	0	0	0	0	0	0	0	1
23.76	3	3	0	0	0	0	0	1
23.92	5	5	0	0	0	0	0	1
24.23	9	9	0	0	0	0	0	1
24.44	12	12	0	0	0	0	0	1
24.61	15	15	0	0	0	0	0	1
24.78	18	18	0	0	0	0	0	1
24.95	21	21	0	0	0	0	0	1
25.12	24	24	0	0	0	0	0	1
25.28	27	27	0	0	0	0	0	1
25.44	30	30	0	0	0	0	0	1
27.64	57.4	57.4	0	0	0	0	0 OVERTOPP	ING

SUMMARY OF ITERATIVE SOLUTION ERRORS FILE: 268-TW DATE: 08-29-2006

HEAD ELEV (ft)	HEAD ERROR (ft)	TOTAL FLOW (cfs)	FLOW ERROR (cfs)	% FLOW ERROR
23.24	0.000	0.00	0.00	0.00
23.76	0.000	3.00	0.00	0.00
23.92	0.000	5.00	0.00	0.00
24.23	0.000	9.00	0.00	0.00
24.44	0.000	12.00	0.00	0.00
24.61	0.000	15.00	0.00	0.00
24.78	0.000	18.00	0.00	0.00
24.95	0.000	21.00	0.00	0.00
25.12	0.000	24.00	0.00	0.00
25.28	0.000	27.00	0.00	0.00
25.44	0.000	30.00	0.00	0.00

<1> TOLERANCE (ft) = 0.010

<2> TOLERANCE (%) = 1.000

CURRENT TIME: 19:31:05

FILE NAME: 268-TW

PERFORMANCE CURVE FOR CULVERT 1 - 1(4.00 (ft) BY 2.40 (ft)) ICMP

DIS- HEAD- INLET OUTLET
 CHARGE WATER CONTROL CONTROL FLOW NORMAL CRIT. OUTLET TW OUTLET TW
 FLOW ELEV. DEPTH DEPTH TYPE DEPTH DEPTH DEPTH DEPTH VEL. VEL.
 (cfs) (ft) (ft) (ft) <F4> (ft) (ft) (ft) (ft) (fps) (fps)

0.00	23.24	0.00	0.00	0-NF	0.00	0.00	0.00	-0.56	0.00	0.00
3.00	23.76	0.52	0.52	1-S2n	0.21	0.26	0.16	0.33	3.59	1.85
5.00	23.92	0.68	0.68	1-S2n	0.30	0.36	0.30	0.39	4.25	1.96
9.00	24.23	0.99	0.99	1-S2n	0.44	0.54	0.34	0.47	6.73	2.10
12.00	24.44	1.20	1.20	1-S2n	0.53	0.65	0.45	0.52	6.70	2.17
15.00	24.61	1.37	1.37	1-S2n	0.61	0.76	0.56	0.56	6.79	2.23
18.00	24.78	1.54	1.54	1-S2n	0.70	0.85	0.69	0.60	6.58	2.29
21.00	24.95	1.71	1.71	1-S2n	0.78	0.95	0.65	0.63	8.23	2.34
24.00	25.12	1.88	1.88	1-S2n	0.85	1.03	0.73	0.65	8.33	2.38
27.00	25.28	2.04	2.04	1-S2n	0.93	1.11	0.81	0.68	8.45	2.42
30.00	25.44	2.20	2.20	1-S2n	1.00	1.19	0.89	0.70	8.54	2.45

El. inlet face invert 23.24 ft El. outlet invert 21.71 ft
 El. inlet throat invert 0.00 ft El. inlet crest 0.00 ft

**** SITE DATA **** CULVERT INVERT ****

INLET STATION 0.00 ft
 INLET ELEVATION 23.24 ft
 OUTLET STATION 58.00 ft
 OUTLET ELEVATION 21.71 ft
 NUMBER OF BARRELS 1
 SLOPE (V/H) 0.0264
 CULVERT LENGTH ALONG SLOPE 58.02 ft

**** CULVERT DATA SUMMARY ****

BARREL SHAPE USER DEFINED
 BARREL SPAN 4.00 ft
 BARREL RISE 2.40 ft
 BARREL MATERIAL STEEL OR ALUMINUM
 BARREL MANNING'S n 0.024 FOR SIDES AND TOP
 0.038 FOR BOTTOM
 INLET TYPE CONVENTIONAL
 INLET EDGE AND WALL MITERED
 INLET DEPRESSION NONE

CURRENT DATE: 08-29-2006
 CURRENT TIME: 19:31:05

FILE DATE: 08-29-2006
 FILE NAME: 268-TW

**** USER DEFINED CULVERT CROSS-SECTION - CULVERT # 1

COORDINATE NUMBER	X (ft)	Y-TOP (ft)	Y-BOTTOM (ft)
1	73.20	23.64	23.64
2	73.21	24.04	23.24
3	73.60	24.88	23.24
4	74.00	25.26	23.24
5	74.40	25.48	23.24
6	74.80	25.60	23.24

7	75.20	25.64	23.24
8	75.60	25.60	23.24
9	76.00	25.48	23.24
10	76.30	25.26	23.24
11	76.70	24.88	23.24
12	77.10	24.04	23.24
13	77.20	23.64	23.64

4

CURRENT DATE: 08-29-2006
CURRENT TIME: 19:31:05

FILE DATE: 08-29-2006
FILE NAME: 268-TW

TAILWATER

***** USER DEFINED CHANNEL CROSS-SECTION FILE NAME: 268TW4
MAIN CHANNEL AND LT & RT OVER BANKS FILE DATE: 08-29-2006
LEFT CHANNEL BOUNDARY 2
RIGHT CHANNEL BOUNDARY 5
MANNING n LEFT OVER BANK 0.050
MANNING n MAIN CHANNEL 0.038
MANNING n RIGHT OVER BANK 0.050
SLOPE OF CHANNEL 0.0053 ft/ft

CROSS-SECTION	X	Y
COORD. NO.	(ft)	(ft)
1	0.00	23.00
2	100.00	21.85
3	100.50	21.15
4	101.50	21.15
5	102.00	21.85
6	202.00	23.00

***** UNIFORM FLOW RATING CURVE FOR DOWNSTREAM CHANNEL

FLOW	W.S.E.	FROUDE	DEPTH	VEL.	SHEAR
(cfs)	(ft)	NUMBER	(ft)	(f/s)	(psf)
0.00	21.15	0.000	-0.56	0.00	0.00
3.00	22.04	0.386	0.33	1.85	0.17
5.00	22.10	0.392	0.39	1.96	0.19
9.00	22.18	0.398	0.47	2.10	0.21
12.00	22.23	0.402	0.52	2.17	0.22
15.00	22.27	0.405	0.56	2.23	0.23
18.00	22.31	0.407	0.60	2.29	0.24
21.00	22.34	0.409	0.63	2.34	0.25
24.00	22.36	0.411	0.65	2.38	0.25
27.00	22.39	0.413	0.68	2.42	0.26
30.00	22.41	0.414	0.70	2.45	0.26

Note: Shear stress was calculated using R.

ROADWAY OVERTOPPING DATA

ROADWAY SURFACE	PAVED
EMBANKMENT TOP WIDTH	24.00 ft
CREST LENGTH	10.00 ft
OVERTOPPING CREST ELEVATION	27.64 ft

248+45

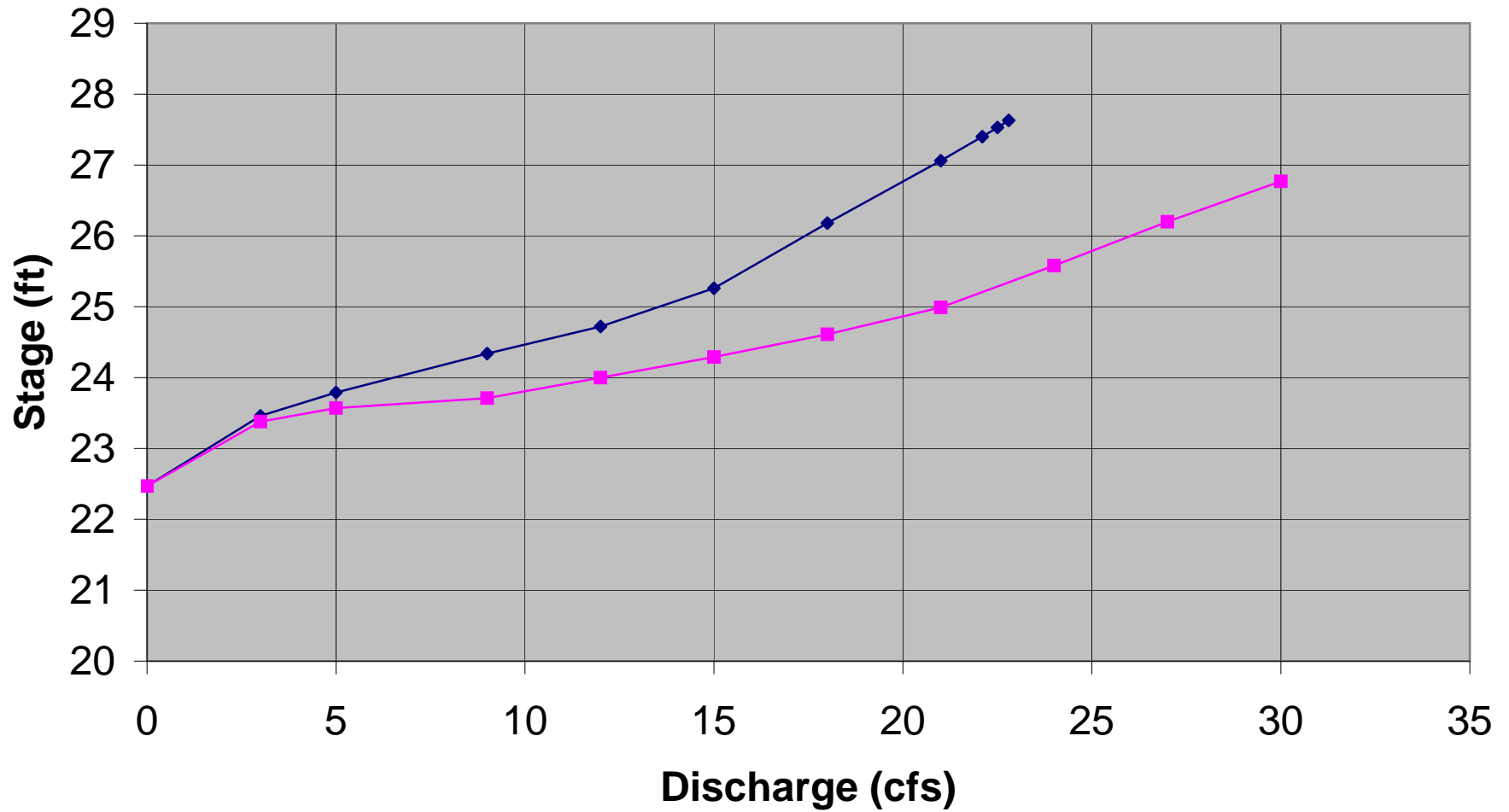

—◆— 271+40-ex —■— 271+40 - Tier 1 3ft cmp

2009 Alignment Station: 248+45

1 2006 S&HI Station 271+40 Existing conditions

CURRENT DATE: 08-25-2006
CURRENT TIME: 11:21:00

FILE DATE: 08-25-2006
FILE NAME: 27140EX

FHWA CULVERT ANALYSIS
HY-8, VERSION 6.1

C	SITE DATA			CULVERT SHAPE, MATERIAL, INLET				
U								
L	INLET	OUTLET	CULVERT	BARRELS				
V	ELEV.	ELEV.	LENGTH	SHAPE	SPAN	RISE	MANNING	INLET
NO.	(ft)	(ft)	(ft)	MATERIAL	(ft)	(ft)	n	TYPE
1	22.47	22.20	58.00	1 CSP	2.00	2.00	.024	CONVENTIONAL
2								
3								
4								
5								
6								

SUMMARY OF CULVERT FLOWS (cfs) FILE: 27140EX DATE: 08-25-2006

ELEV (ft)	TOTAL	1	2	3	4	5	6 ROADWAY	ITR
22.47	0	0	0	0	0	0	0	1
23.46	3	3	0	0	0	0	0	1
23.79	5	5	0	0	0	0	0	1
24.34	9	9	0	0	0	0	0	1
24.72	12	12	0	0	0	0	0	1
25.26	15	15	0	0	0	0	0	1
26.18	18	18	0	0	0	0	0	1
27.06	21	21	0	0	0	0	0	1
27.4	24	22.1	0	0	0	0	1.7	6
27.53	27	22.5	0	0	0	0	4.33	4
27.63	30	22.8	0	0	0	0	7.08	4
27.25	21.6	21.6	0	0	0	0	0 OVERTOPP	ING

SUMMARY OF ITERATIVE SOLUTION ERRORS FILE: 27140EX DATE: 08-25-2006

HEAD ELEV (ft)	HEAD ERROR (ft)	TOTAL FLOW (cfs)	FLOW ERROR (cfs)	% FLOW ERROR
22.47	0.000	0.00	0.00	0.00
23.46	0.000	3.00	0.00	0.00
23.79	0.000	5.00	0.00	0.00
24.34	0.000	9.00	0.00	0.00
24.72	0.000	12.00	0.00	0.00
25.26	0.000	15.00	0.00	0.00
26.18	0.000	18.00	0.00	0.00
27.06	0.000	21.00	0.00	0.00

27.40	-0.007	24.00	0.22	0.92
27.53	-0.004	27.00	0.18	0.67
27.63	-0.008	30.00	0.09	0.30

<1> TOLERANCE (ft) = 0.010

<2> TOLERANCE (%) = 1.000

2

CURRENT DATE: 08-25-2006
 CURRENT TIME: 11:21:00

FILE DATE: 08-25-2006
 FILE NAME: 27140EX

PERFORMANCE CURVE FOR CULVERT 1 - 1(2.00 (ft) BY 2.00 (ft)) CSP

DIS- HEAD- INLET OUTLET

CHARGE WATER CONTROL CONTROL FLOW NORMAL CRIT. OUTLET TW OUTLET TW
 FLOW ELEV. DEPTH DEPTH TYPE DEPTH DEPTH DEPTH DEPTH VEL. VEL.
 (cfs) (ft) (ft) (ft) <F4> (ft) (ft) (ft) (ft) (fps) (fps)

0.00	22.47	0.00	0.00	0-NF	0.00	0.00	0.00	-0.54	0.00	0.00
3.00	23.46	0.90	0.99	2-M2c	0.82	0.60	0.60	0.22	3.75	2.00
5.00	23.79	1.19	1.32	2-M2c	1.11	0.79	0.79	0.31	4.36	2.17
9.00	24.34	1.70	1.87	2-M2c	2.00	1.07	1.07	0.39	5.28	2.34
12.00	24.72	2.09	2.25	2-M2c	2.00	1.24	1.24	0.43	5.85	2.42
15.00	25.26	2.53	2.79	2-M2c	2.00	1.40	1.40	0.47	6.41	2.48
18.00	26.18	3.05	3.71	2-M2c	2.00	1.52	1.52	0.50	7.03	2.54
21.00	27.06	3.67	4.59	2-M2c	2.00	1.63	1.63	0.53	7.63	2.59
22.09	27.40	3.92	4.93	2-M2c	2.00	1.67	1.67	0.55	7.92	2.63
22.49	27.52	4.02	5.05	2-M2c	2.00	1.68	1.68	0.57	8.02	2.67
22.83	27.63	4.10	5.16	2-M2c	2.00	1.69	1.69	0.59	8.10	2.71

El. inlet face invert 22.47 ft El. outlet invert 22.20 ft
 El. inlet throat invert 0.00 ft El. inlet crest 0.00 ft

***** SITE DATA ***** CULVERT INVERT *****

INLET STATION	0.00 ft
INLET ELEVATION	22.47 ft
OUTLET STATION	58.00 ft
OUTLET ELEVATION	22.20 ft
NUMBER OF BARRELS	1
SLOPE (V/H)	0.0047
CULVERT LENGTH ALONG SLOPE	58.00 ft

***** CULVERT DATA SUMMARY *****

BARREL SHAPE	CIRCULAR
BARREL DIAMETER	2.00 ft
BARREL MATERIAL	CORRUGATED STEEL
BARREL MANNING'S n	0.024
INLET TYPE	CONVENTIONAL
INLET EDGE AND WALL	THIN EDGE PROJECTING
INLET DEPRESSION	NONE

CURRENT DATE: 08-25-2006
CURRENT TIME: 11:21:00

FILE DATE: 08-25-2006
FILE NAME: 27140EX

TAILWATER

***** USER DEFINED CHANNEL CROSS-SECTION FILE NAME: 27140TW
MAIN CHANNEL AND LT & RT OVER BANKS FILE DATE: 08-25-2006
LEFT CHANNEL BOUNDARY 2
RIGHT CHANNEL BOUNDARY 5
MANNING n LEFT OVER BANK 0.050
MANNING n MAIN CHANNEL 0.035
MANNING n RIGHT OVER BANK 0.050
SLOPE OF CHANNEL 0.0053 ft/ft

CROSS-SECTION	X	Y
COORD. NO.	(ft)	(ft)
1	0.00	23.00
2	100.00	22.36
3	100.50	21.66
4	102.50	21.66
5	103.00	22.36
6	203.00	23.00

***** UNIFORM FLOW RATING CURVE FOR DOWNSTREAM CHANNEL

FLOW	W.S.E.	FROUDE	DEPTH	VEL.	SHEAR
(cfs)	(ft)	NUMBER	(ft)	(f/s)	(psf)
0.00	21.66	0.000	-0.54	0.00	0.00
3.00	22.42	0.439	0.22	2.00	0.17
5.00	22.51	0.448	0.31	2.17	0.19
9.00	22.59	0.456	0.39	2.34	0.22
12.00	22.64	0.460	0.43	2.42	0.23
15.00	22.67	0.463	0.47	2.48	0.24
18.00	22.70	0.466	0.50	2.54	0.25
21.00	22.73	0.468	0.53	2.59	0.25
24.00	22.75	0.470	0.55	2.63	0.26
27.00	22.77	0.472	0.57	2.67	0.27
30.00	22.79	0.473	0.59	2.71	0.27

Note: Shear stress was calculated using R.

ROADWAY OVERTOPPING DATA

ROADWAY SURFACE	PAVED
EMBANKMENT TOP WIDTH	24.00 ft
CREST LENGTH	10.00 ft
OVERTOPPING CREST ELEVATION	27.25 ft

2009 Alignment Station: 248+45

1 2006 S&HI Station 271+40 Tier 1 fish passage - 3-ft CMP

CURRENT DATE: 08-29-2006
CURRENT TIME: 20:14:01

FILE DATE: 08-29-2006
FILE NAME: 271-T3

FHWA CULVERT ANALYSIS
HY-8, VERSION 6.1

C	SITE DATA			CULVERT SHAPE, MATERIAL, INLET					
U	L	INLET	OUTLET	CULVERT	BARRELS				
V	ELEV.	ELEV.	LENGTH	SHAPE	SPAN	RISE	MANNING	INLET	
NO.	(ft)	(ft)	(ft)	MATERIAL	(ft)	(ft)	n	TYPE	
1	22.47	22.20	58.00	1 ICMP	3.10	1.80	.024	CONVENTIONAL	
2									
3									
4									
5									
6									

SUMMARY OF CULVERT FLOWS (cfs) FILE: 271-T3 DATE: 08-29-2006

ELEV (ft)	TOTAL	1	2	3	4	5	6	ROADWAY	ITR
22.47	0	0	0	0	0	0	0	0	1
23.38	3	3	0	0	0	0	0	0	1
23.57	5	5	0	0	0	0	0	0	1
23.71	9	9	0	0	0	0	0	0	1
24	12	12	0	0	0	0	0	0	1
24.29	15	15	0	0	0	0	0	0	1
24.61	18	18	0	0	0	0	0	0	1
24.99	21	21	0	0	0	0	0	0	1
25.58	24	24	0	0	0	0	0	0	1
26.2	27	27	0	0	0	0	0	0	1
26.77	30	30	0	0	0	0	0	0	1
27.25	32	32	0	0	0	0	0	0 OVERTOPP	ING

SUMMARY OF ITERATIVE SOLUTION ERRORS FILE: 271-T3 DATE: 08-29-2006

HEAD	HEAD	TOTAL	FLOW	% FLOW
ELEV (ft)	ERROR (ft)	FLOW (cfs)	ERROR (cfs)	ERROR
22.47	0.000	0.00	0.00	0.00
23.38	0.000	3.00	0.00	0.00
23.57	0.000	5.00	0.00	0.00
23.71	0.000	9.00	0.00	0.00
24.00	0.000	12.00	0.00	0.00
24.29	0.000	15.00	0.00	0.00

24.61	0.000	18.00	0.00	0.00
24.99	0.000	21.00	0.00	0.00
25.58	0.000	24.00	0.00	0.00
26.20	0.000	27.00	0.00	0.00
26.77	0.000	30.00	0.00	0.00

<1> TOLERANCE (ft) = 0.010

<2> TOLERANCE (%) = 1.000

2

CURRENT DATE: 08-29-2006
CURRENT TIME: 20:14:01

FILE DATE: 08-29-2006
FILE NAME: 271-T3

PERFORMANCE CURVE FOR CULVERT 1 - 1(3.10 (ft) BY 1.80 (ft)) ICMP

DIS- HEAD- INLET OUTLET

CHARGE WATER CONTROL CONTROL FLOW NORMAL CRIT. OUTLET TW OUTLET TW
FLOW ELEV. DEPTH DEPTH TYPE DEPTH DEPTH DEPTH DEPTH VEL. VEL.
(cfs) (ft) (ft) (ft) <F4> (ft) (ft) (ft) (ft) (fps) (fps)

0.00	22.47	0.00	0.00	0-NF	0.00	0.00	0.00	-0.54	0.00	0.00
3.00	23.38	0.91	0.57	2-M2c	0.46	0.31	0.31	0.24	3.22	1.88
5.00	23.57	1.10	0.82	2-M2c	0.66	0.44	0.44	0.32	3.81	2.02
9.00	23.71	1.18	1.24	2-M2c	1.06	0.64	0.64	0.40	4.70	2.16
12.00	24.00	1.44	1.53	2-M2c	1.43	0.78	0.78	0.44	5.23	2.24
15.00	24.29	1.69	1.82	2-M2c	1.80	0.90	0.90	0.47	5.70	2.30
18.00	24.61	1.97	2.14	2-M2c	1.80	1.02	1.02	0.50	6.16	2.35
21.00	24.99	2.35	2.52	2-M2c	1.80	1.13	1.13	0.53	6.56	2.39
24.00	25.58	2.75	3.11	2-M2c	1.80	1.23	1.23	0.55	6.99	2.43
27.00	26.20	3.18	3.73	2-M2c	1.80	1.31	1.31	0.58	7.46	2.47
30.00	26.77	3.64	4.30	2-M2c	1.80	1.39	1.39	0.60	7.94	2.50

El. inlet face invert 22.47 ft El. outlet invert 22.20 ft
El. inlet throat invert 0.00 ft El. inlet crest 0.00 ft

***** SITE DATA ***** CULVERT INVERT *****

INLET STATION 0.00 ft
INLET ELEVATION 22.47 ft
OUTLET STATION 58.00 ft
OUTLET ELEVATION 22.20 ft
NUMBER OF BARRELS 1
SLOPE (V/H) 0.0047
CULVERT LENGTH ALONG SLOPE 58.00 ft

***** CULVERT DATA SUMMARY *****

BARREL SHAPE USER DEFINED
BARREL SPAN 3.10 ft
BARREL RISE 1.80 ft
BARREL MATERIAL STEEL OR ALUMINUM
BARREL MANNING'S n 0.024 FOR SIDES AND TOP

0.038 FOR BOTTOM
INLET TYPE CONVENTIONAL
INLET EDGE AND WALL MITERED
INLET DEPRESSION NONE

3

CURRENT DATE: 08-29-2006
CURRENT TIME: 20:14:01

FILE DATE: 08-29-2006
FILE NAME: 271-T3

***** USER DEFINED CULVERT CROSS-SECTION - CULVERT # 1

COORDINATE NUMBER	X (ft)	Y-TOP (ft)	Y-BOTTOM (ft)
1	73.30	22.77	22.77
2	73.40	23.07	22.47
3	73.70	23.70	22.47
4	74.00	23.98	22.47
5	74.30	24.15	22.47
6	74.60	24.24	22.47
7	74.80	24.27	22.47
8	75.10	24.24	22.47
9	75.40	24.15	22.47
10	75.70	23.98	22.47
11	76.00	23.70	22.47
12	76.30	23.07	22.47
13	76.40	22.77	22.77

4

CURRENT DATE: 08-29-2006
CURRENT TIME: 20:14:01

FILE DATE: 08-29-2006
FILE NAME: 271-T3

TAILWATER

***** USER DEFINED CHANNEL CROSS-SECTION

FILE NAME: 271-T3
FILE DATE: 08-29-2006

MAIN CHANNEL AND LT & RT OVER BANKS
LEFT CHANNEL BOUNDARY 2
RIGHT CHANNEL BOUNDARY 5
MANNING n LEFT OVER BANK 0.050
MANNING n MAIN CHANNEL 0.038
MANNING n RIGHT OVER BANK 0.050
SLOPE OF CHANNEL 0.0053 ft/ft

CROSS-SECTION X Y

COORD. NO.	(ft)	(ft)
1	0.00	23.00
2	100.00	22.36
3	100.50	21.66
4	102.50	21.66
5	103.00	22.36
6	203.00	23.00

***** UNIFORM FLOW RATING CURVE FOR DOWNSTREAM CHANNEL

FLOW (cfs)	W.S.E. (ft)	FROUDE NUMBER	DEPTH (ft)	VEL. (f/s)	SHEAR (psf)
0.00	21.66	0.000	-0.54	0.00	0.00
3.00	22.44	0.406	0.24	1.88	0.18
5.00	22.52	0.413	0.32	2.02	0.20
9.00	22.60	0.421	0.40	2.16	0.22
12.00	22.64	0.424	0.44	2.24	0.23
15.00	22.67	0.427	0.47	2.30	0.24
18.00	22.70	0.429	0.50	2.35	0.25
21.00	22.73	0.431	0.53	2.39	0.25
24.00	22.75	0.433	0.55	2.43	0.26
27.00	22.78	0.435	0.58	2.47	0.27
30.00	22.80	0.436	0.60	2.50	0.27

Note: Shear stress was calculated using R.

ROADWAY OVERTOPPING DATA

ROADWAY SURFACE	PAVED
EMBANKMENT TOP WIDTH	24.00 ft
CREST LENGTH	10.00 ft
OVERTOPPING CREST ELEVATION	27.25 ft

Station 292+90

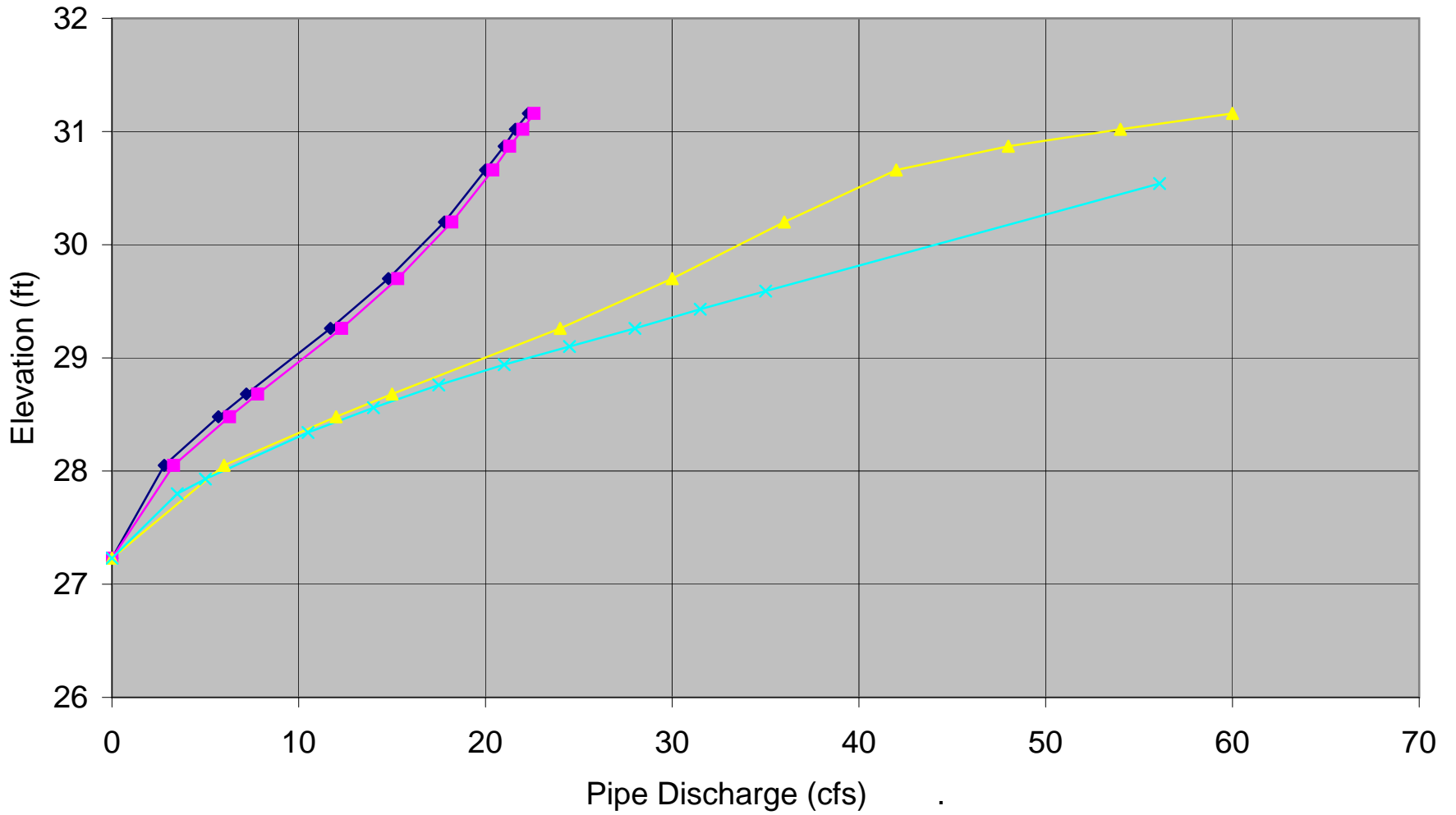

◆ 316-Ex 1 ■ 316-Ex 2 ▲ 316-Ex total × 316 - Tier 2 48bfd - Qtotal

2009 Alignment Station: 292+90

1 2006 S&HI Station 316+00 Existing conditions

CURRENT DATE: 08-17-2006
CURRENT TIME: 13:41:30

FILE DATE: 08-17-2006
FILE NAME: 316-EX

FHWA CULVERT ANALYSIS
HY-8, VERSION 6.1

C	SITE DATA		CULVERT SHAPE, MATERIAL, INLET						
U									
L	INLET	OUTLET	CULVERT	BARRELS					
V	ELEV.	ELEV.	LENGTH	SHAPE	SPAN	RISE	MANNING	INLET	
NO.	(ft)	(ft)	(ft)	MATERIAL	(ft)	(ft)	n	TYPE	
1	27.23	25.55	49.03	1 CSP	2.00	2.00	.024	CONVENTIONAL	
2	27.15	25.52	50.03	1 CSP	2.00	2.00	.024	CONVENTIONAL	
3									
4									
5									
6									

SUMMARY OF CULVERT FLOWS (cfs) FILE: 316-EX DATE: 08-17-2006

ELEV (ft)	TOTAL	1	2	3	4	5	6	ROADWAY	INTR
27.23	0	0	0	0	0	0	0	0	0
28.05	6	2.8	3.3	0	0	0	0	0	4
28.48	12	5.7	6.3	0	0	0	0	0	3
28.68	15	7.2	7.8	0	0	0	0	0	2
29.26	24	11.7	12.3	0	0	0	0	0	3
29.7	30	14.8	15.3	0	0	0	0	0	3
30.2	36	17.8	18.2	0	0	0	0	0	3
30.66	42	20	20.4	0	0	0	0	1.2	5
30.87	48	21	21.3	0	0	0	0	5.55	4
31.02	54	21.6	22	0	0	0	0	10.05	3
31.16	60	22.3	22.6	0	0	0	0	14.9	3
30.54	39.3	19.5	19.9	0	0	0	0	0	OVERTOPPING

SUMMARY OF ITERATIVE SOLUTION ERRORS FILE: 316-EX DATE: 08-17-2006

HEAD ELEV (ft)	HEAD ERROR (ft)	TOTAL FLOW (cfs)	FLOW ERROR (cfs)	% FLOW ERROR
27.23	0.000	0.00	0.00	0.00
28.05	-0.005	6.00	0.00	0.00
28.48	0.001	12.00	-0.01	-0.08
28.68	0.003	15.00	-0.05	-0.33
29.26	0.002	24.00	-0.03	-0.13
29.70	0.004	30.00	-0.05	-0.17
30.20	-0.006	36.00	0.09	0.25
30.66	-0.010	42.00	0.35	0.83
30.87	-0.004	48.00	0.19	0.40
31.02	-0.006	54.00	0.33	0.61
31.16	-0.005	60.00	0.26	0.43

<1> TOLERANCE (ft) = 0.010

<2> TOLERANCE (%) = 1.000

2

CURRENT DATE: 08-17-2006
CURRENT TIME: 13:41:30

FILE DATE: 08-17-2006
FILE NAME: 316-EX

PERFORMANCE CURVE FOR CULVERT 1 - 1(2.00 (ft) BY 2.00 (ft)) CSP

DIS-CHARGE FLOW (cfs)	HEAD-WATER ELEV. (ft)	INLET CONTROL DEPTH (ft)	OUTLET CONTROL DEPTH (ft)	FLOW TYPE <F4>	NORMAL DEPTH (ft)	CRIT. DEPTH (ft)	OUTLET DEPTH (ft)	TW DEPTH (ft)	OUTLET VEL. (fps)	TW VEL. (fps)
0	27.23	0	0	0-NF	0	0	0	0.02	0	0
2.75	28.06	0.83	0.83	1-S2n	0.46	0.57	0.37	0.34	6.69	1.75
5.73	28.49	1.26	1.26	1-S2n	0.68	0.84	0.67	0.48	6.16	2.19
7.22	28.68	1.45	1.45	1-S2n	0.77	0.95	0.65	0.54	8.12	2.37
11.73	29.26	2.03	2.03	5-S2n	1.02	1.23	0.93	0.69	8.22	2.78
14.78	29.7	2.47	2.47	5-S2n	1.17	1.38	1.08	0.78	8.5	3
17.75	30.2	2.97	2.97	5-S2n	1.33	1.51	1.21	0.87	8.91	3.19
20.04	30.66	3.43	3.43	5-S2n	1.46	1.61	1.41	0.95	8.49	3.36
20.95	30.86	3.63	3.63	5-S2n	1.52	1.63	1.43	1.02	8.69	3.51
21.64	31.01	3.78	3.78	5-S2n	1.56	1.65	1.45	1.09	8.87	3.65
22.26	31.16	3.93	3.93	5-S2n	1.6	1.67	1.59	1.15	8.31	3.77

El. inlet face invert 27.23 ft El. outlet invert 25.55 ft
El. inlet throat invert 0.00 ft El. inlet crest 0.00 ft

***** SITE DATA ***** CULVERT INVERT *****

INLET STATION 1.00 ft
INLET ELEVATION 27.23 ft
OUTLET STATION 50.00 ft
OUTLET ELEVATION 25.55 ft
NUMBER OF BARRELS 1
SLOPE (V/H) 0.0343
CULVERT LENGTH ALONG SLOPE 49.03 ft

***** CULVERT DATA SUMMARY *****

BARREL SHAPE CIRCULAR
BARREL DIAMETER 2.00 ft
BARREL MATERIAL CORRUGATED STEEL
BARREL MANNING'S n 0.024
INLET TYPE CONVENTIONAL
INLET EDGE AND WALL THIN EDGE PROJECTING
INLET DEPRESSION NONE

3

CURRENT DATE: 08-17-2006
CURRENT TIME: 13:41:30

FILE DATE: 08-17-2006
FILE NAME: 316-EX

PERFORMANCE CURVE FOR CULVERT 2 - 1(2.00 (ft) BY 2.00 (ft)) CSP

DIS- HEAD- INLET OUTLET
 CHARGE WATER CONTROL CONTROL FLOW NORMAL CRIT. OUTLET TW OUTLET TW
 FLOW ELEV. DEPTH DEPTH TYPE DEPTH DEPTH DEPTH DEPTH VEL. VEL.
 (cfs) (ft) (ft) (ft) <F4> (ft) (ft) (ft) (ft) (fps) (fps)

0.00	27.15	0.00	0.00	0-NF	0.00	0.00	0.00	0.05	0.00	0.00
3.25	28.06	0.91	0.91	1-S2n	0.51	0.63	0.43	0.37	6.70	1.75
6.28	28.48	1.33	1.33	1-S2n	0.72	0.88	0.72	0.51	6.13	2.19
7.83	28.68	1.53	1.53	1-S2n	0.82	0.99	0.69	0.57	8.04	2.37
12.30	29.25	2.10	2.10	5-S2n	1.06	1.26	0.96	0.72	8.28	2.78
15.27	29.70	2.55	2.55	5-S2n	1.22	1.41	1.11	0.81	8.56	3.00
18.16	30.20	3.05	3.05	5-S2n	1.38	1.53	1.37	0.90	7.93	3.19
20.41	30.66	3.51	3.51	5-S2n	1.52	1.62	1.42	0.98	8.57	3.36
21.30	30.86	3.71	3.71	5-S2n	1.58	1.64	1.44	1.05	8.76	3.51
21.98	31.01	3.86	3.86	5-S2n	1.63	1.66	1.56	1.12	8.36	3.65
22.58	31.16	4.01	3.59	2-M2c	1.69	1.68	1.68	1.18	8.04	3.77

El. inlet face invert 27.15 ft El. outlet invert 25.52 ft
 El. inlet throat invert 0.00 ft El. inlet crest 0.00 ft

***** SITE DATA ***** CULVERT INVERT *****

INLET STATION 0.00 ft
 INLET ELEVATION 27.15 ft
 OUTLET STATION 50.00 ft
 OUTLET ELEVATION 25.52 ft
 NUMBER OF BARRELS 1
 SLOPE (V/H) 0.0326
 CULVERT LENGTH ALONG SLOPE 50.03 ft

***** CULVERT DATA SUMMARY *****

BARREL SHAPE CIRCULAR
 BARREL DIAMETER 2.00 ft
 BARREL MATERIAL CORRUGATED STEEL
 BARREL MANNING'S n 0.024
 INLET TYPE CONVENTIONAL
 INLET EDGE AND WALL THIN EDGE PROJECTING
 INLET DEPRESSION NONE

4

CURRENT DATE: 08-17-2006
 CURRENT TIME: 13:41:30

FILE DATE: 08-17-2006
 FILE NAME: 316-EX

TAILWATER

***** USER DEFINED CHANNEL CROSS-SECTION

MAIN CHANNEL AND LT & RT OVER BANKS
 LEFT CHANNEL BOUNDARY 2
 RIGHT CHANNEL BOUNDARY 5
 MANNING n LEFT OVER BANK 0.050

FILE NAME: 316-TW
 FILE DATE: 08-17-2006

MANNING n MAIN CHANNEL 0.038
MANNING n RIGHT OVER BANK 0.050
SLOPE OF CHANNEL 0.0100 ft/ft

CROSS-SECTION X Y
COORD. NO. (ft) (ft)
1 0.00 29.32
2 17.50 28.65
3 23.50 25.57
4 35.50 25.57
5 40.50 28.02
6 58.50 29.30

***** UNIFORM FLOW RATING CURVE FOR DOWNSTREAM CHANNEL

FLOW (cfs)	W.S.E. (ft)	FROUDE NUMBER	DEPTH (ft)	VEL. (f/s)	SHEAR (psf)
0.00	25.57	0.000	0.02	0.00	0.00
6.00	25.89	0.560	0.34	1.75	0.19
12.00	26.03	0.592	0.48	2.19	0.26
15.00	26.09	0.603	0.54	2.37	0.29
24.00	26.24	0.626	0.69	2.78	0.37
30.00	26.33	0.637	0.78	3.00	0.42
36.00	26.42	0.646	0.87	3.19	0.46
42.00	26.50	0.654	0.95	3.36	0.50
48.00	26.57	0.661	1.02	3.51	0.53
54.00	26.64	0.667	1.09	3.65	0.56
60.00	26.70	0.672	1.15	3.77	0.59

Note: Shear stress was calculated using R.

ROADWAY OVERTOPPING DATA

ROADWAY SURFACE PAVED
EMBANKMENT TOP WIDTH 24.00 ft
CREST LENGTH 10.00 ft
OVERTOPPING CREST ELEVATION 30.54 ft

2009 Alignment Station: 292+90
 2006 S&H Station 316+00 Tier 2 FISH PASS design

Baffle design: Juvenile Fish

Weir Baffle						
Weak Swimming Fish Length (mm)	Slope (%)	Manning n Wall	Q Fish (cfs)	Q Flood (cfs)	Culvert Diameter (ft)	
96	3.4	0.024	5.4	36	3	
Calculated Parameters						
Weir Height .1 = D .15 = D						
Water Velocity in small fish passage zone (ft/sec)	4.11		2.97			
Fish power required at weir (watts)	0.24		0.12			
Fish power capabilities (watts)	0.26		0.26			
Depth of flow over weir (ft)	0.75		0.53			
Depth of flow at outlet (ft)	1.05		0.98			
Normal Depth at flood flow (ft)	2.18		2.42			
Acceptable Design						

Adult fish - 600-mm

Weir Baffle						
Weak Swimming Fish Length (mm)	Slope (%)	Manning n Wall	Q Fish (cfs)	Q Flood (cfs)	Culvert Diameter (ft)	
600	3.4	0.024	5.4	36	3	
Calculated Parameters						
Weir Height .1 = D .15 = D						
Water Velocity in small fish passage zone (ft/sec)	4.11		2.97			
Fish power required at weir (watts)	7.37		3.92			
Fish power capabilities (watts)	62.55		62.55			
Depth of flow over weir (ft)	0.75		0.53			
Depth of flow at outlet (ft)	1.05		0.98			
Normal Depth at flood flow (ft)	2.18		2.42			
Acceptable Design						

Adult fish - adjusted to 'equivalent' grayling

Weir Baffle						
Weak Swimming Fish Length (mm)	Slope (%)	Manning n Wall	Q Fish (cfs)	Q Flood (cfs)	Culvert Diameter (ft)	
942	3.4	0.024	5.4	36	3	
Calculated Parameters						
Weir Height .1 = D .15 = D						
Water Velocity in small fish passage zone (ft/sec)	4.11		2.97			
Fish power required at weir (watts)	18.23		10.09			
Fish power capabilities (watts)	242.05		242.05			
Depth of flow over weir (ft)	0.75		0.53			
Depth of flow at outlet (ft)	1.05		0.98			
Normal Depth at flood flow (ft)	2.18		2.42			
Acceptable Design						

non-baffle design big pipe:

Weak Swimming Fish Passage									
Fish Length (mm)	Culvert (ft)	Slope (%)	Manning n Wall	Q Bed (cfs)	Q Culvert (cfs)	Diam. (ft)	Bed (ft)	Outlet (ft)	Depth (ft)
96	30	3.4	0.024	0.24	5.4	5	1	1.5	1.5
Calculated Fish Parameters									
Allowable Vel.	4.4 ft/sec	Min. Flow Depth	0.29 ft	Possible Power	0.42 watts	Outlet	0.77	Inlet	
Possible Energy (joules)									
Calculated Flow Parameters									
Depth (ft)	0.28	Normal Flow	0.38	Critical Flow					
Avg. cross-section, water velocity (ft/sec)	4.57		3.39						
Fish power required in outlet zone (watts)									
Fish energy required in outlet zone (joules)									
Fish power required at inlet (watts)									
Fish energy required at inlet (joules)									
Normal Flow Supercritical Normal Depth too Shallow									

Backwater Inlet CalcMode cOrrugations									
Fish Length (mm)	Culvert (ft)	Slope (%)	Manning n Wall	Q Bed (cfs)	Q Culvert (cfs)	Diam. (ft)	Bed (ft)	Outlet (ft)	Depth (ft)
600	30	3.4	0.024	0.24	5.4	5	1	1.5	1.5
Calculated Fish Parameters									
Allowable Vel.	5.5 ft/sec	Min. Flow Depth	0.23 ft	Possible Power	38.11 watts	Outlet	187.50	Inlet	
Possible Energy (joules)									
Calculated Flow Parameters									
Depth (ft)	0.28	Normal Flow	0.38	Critical Flow					
Avg. cross-section, water velocity (ft/sec)	4.57		3.39						
Fish power required in outlet zone (watts)									
Fish energy required in outlet zone (joules)									
Fish power required at inlet (watts)									
Fish energy required at inlet (joules)									
Normal Flow Supercritical Barrel Full during backwater calc									

Backwater Inlet CalcMode cOrrugations									
Fish Length (mm)	Culvert (ft)	Slope (%)	Manning n Wall	Q Bed (cfs)	Q Culvert (cfs)	Diam. (ft)	Bed (ft)	Outlet (ft)	Depth (ft)
942	30	3.4	0.024	0.24	5.4	5	1	1.5	1.5
Calculated Fish Parameters									
Allowable Vel.	5.5 ft/sec	Min. Flow Depth	0.24 ft	Possible Power	115.59 watts	Outlet	725.60	Inlet	
Possible Energy (joules)									
Calculated Flow Parameters									
Depth (ft)	0.28	Normal Flow	0.38	Critical Flow					
Avg. cross-section, water velocity (ft/sec)	4.57		3.39						
Fish power required in outlet zone (watts)									
Fish energy required in outlet zone (joules)									
Fish power required at inlet (watts)									
Fish energy required at inlet (joules)									
Normal Flow Supercritical Barrel Full during backwater calc									

2009 Alignment Station: 292+90

1 2006 S&HI Station 316+00 Tier 2 fish passage - 4-ft baffled CMP

CURRENT DATE: 09-07-2006
CURRENT TIME: 16:17:10

FILE DATE: 09-07-2006
FILE NAME: 316T2-4B

FHWA CULVERT ANALYSIS
HY-8, VERSION 6.1

C	SITE DATA			CULVERT SHAPE, MATERIAL, INLET						
U	L	INLET	OUTLET	CULVERT	BARRELS					
V	ELEV.	ELEV.	LENGTH	SHAPE	SPAN	RISE	MANNING	INLET		
NO.	(ft)	(ft)	(ft)	MATERIAL	(ft)	(ft)	n	TYPE		
1	27.23	25.55	50.03	1 ICMP	4.00	3.40	.024	CONVENTIONAL		
2										
3										
4										
5										
6										

SUMMARY OF CULVERT FLOWS (cfs) FILE: 316T2-4B DATE: 09-07-2006

ELEV (ft)	TOTAL	1	2	3	4	5	6	ROADWA`	ITR
27.23	0	0	0	0	0	0	0	0	1
27.8	3.5	3.5	0	0	0	0	0	0	1
27.93	5	5	0	0	0	0	0	0	1
28.34	10.5	10.5	0	0	0	0	0	0	1
28.56	14	14	0	0	0	0	0	0	1
28.76	17.5	17.5	0	0	0	0	0	0	1
28.94	21	21	0	0	0	0	0	0	1
29.1	24.5	24.5	0	0	0	0	0	0	1
29.26	28	28	0	0	0	0	0	0	1
29.43	31.5	31.5	0	0	0	0	0	0	1
29.59	35	35	0	0	0	0	0	0	1
30.54	56.1	56.1	0	0	0	0	0	0	1

SUMMARY OF ITERATIVE SOLUTION ERRORS FILE: 316T2-4B DATE: 09-07-2006

HEAD	HEAD	TOTAL	FLOW	% FLOW
ELEV (ft)	ERROR (ft)	FLOW (cfs)	ERROR (cfs)	ERROR
27.23	0.000	0.00	0.00	0.00
27.80	0.000	3.50	0.00	0.00
27.93	0.000	5.00	0.00	0.00
28.34	0.000	10.50	0.00	0.00
28.56	0.000	14.00	0.00	0.00
28.76	0.000	17.50	0.00	0.00
28.94	0.000	21.00	0.00	0.00
29.10	0.000	24.50	0.00	0.00
29.26	0.000	28.00	0.00	0.00
29.43	0.000	31.50	0.00	0.00
29.59	0.000	35.00	0.00	0.00

<1> TOLERANCE (ft) = 0.010

<2> TOLERANCE (%) = 1.000

2

CURRENT DATE: 09-07-2006
CURRENT TIME: 16:17:10

FILE DATE: 09-07-2006
FILE NAME: 316T2-4B

PERFORMANCE CURVE FOR CULVERT 1 - 1(4.00 (ft) BY 3.40 (ft)) ICMP

DIS- FLOW (cfs)	HEAD (ft)	INLET (ft)	OUTLET (ft)	CONTROL	CONTROL	FLOW TYPE	NORMAL DEPTH (ft)	CRIT. DEPTH (ft)	OUTLET DEPTH (ft)	TW DEPTH (ft)	OUTLET DEPTH (ft)	TW VEL. (fps)	VEL. (fps)
0.00	27.23	0.00	0.00	0-NF	0.00	0.00	0.00	0.02	0.00	0.00	0.00	0.00	0.00
3.50	27.80	0.57	0.57	1-S2n	0.23	0.35	0.15	0.26	4.89	1.50			
5.00	27.93	0.70	0.70	1-S2n	0.32	0.42	0.22	0.31	5.35	1.67			
10.50	28.34	1.11	1.11	1-S2n	0.50	0.69	0.39	0.44	8.37	2.13			
14.00	28.56	1.33	1.33	1-S2n	0.60	0.82	0.52	0.51	8.18	2.35			
17.50	28.76	1.53	1.53	1-S2n	0.70	0.95	0.65	0.58	8.07	2.53			
21.00	28.94	1.71	1.71	1-S2n	0.78	1.07	0.67	0.64	9.40	2.69			
24.50	29.10	1.87	1.87	1-S2n	0.86	1.17	0.77	0.69	9.32	2.84			
28.00	29.26	2.03	2.03	1-S2n	0.94	1.28	0.88	0.75	9.25	2.97			
31.50	29.43	2.20	2.20	1-S2n	1.02	1.38	1.03	0.80	8.81	3.09			
35.00	29.59	2.36	2.36	1-S2n	1.09	1.47	1.10	0.85	9.05	3.20			

El. inlet face invert 27.23 ft El. outlet invert 25.55 ft
El. inlet throat invert 0.00 ft El. inlet crest 0.00 ft

***** SITE DATA ***** CULVERT INVERT *****

INLET STATION	0.00 ft
INLET ELEVATION	27.23 ft
OUTLET STATION	50.00 ft
OUTLET ELEVATION	25.55 ft
NUMBER OF BARRELS	1
SLOPE (V/H)	0.0336
CULVERT LENGTH ALONG SLOPE	50.03 ft

***** CULVERT DATA SUMMARY *****

BARREL SHAPE	USER DEFINED
BARREL SPAN	4.00 ft
BARREL RISE	3.40 ft
BARREL MATERIAL	STEEL OR ALUMINUM
BARREL MANNING'S n	0.024 FOR SIDES AND TOP 0.038 FOR BOTTOM
INLET TYPE	CONVENTIONAL
INLET EDGE AND WALL	MITERED
INLET DEPRESSION	NONE

3

CURRENT DATE: 09-07-2006

FILE DATE: 09-07-2006

CURRENT TIME: 16:17:10

FILE NAME: 316T2-4B

***** USER DEFINED CULVERT CROSS-SECTION - CULVERT # 1

COORDIN X NUMBER (ft)	Y-TOP (ft)	Y-BOTTOM (ft)	Y-BOTTOM (ft)
1	0	28.63	28.63
2	0.19	29.48	27.78
3	0.38	29.8	27.46
4	0.57	30.03	27.23
5	0.93	30.32	27.23
6	1.29	30.5	27.23
7	1.64	30.6	27.23
8	2	30.63	27.23
9	2.36	30.6	27.23
10	2.71	30.5	27.23
11	3.07	30.32	27.23
12	3.43	30.03	27.23
13	3.62	29.8	27.46
14	3.81	29.48	27.78
15	4	28.63	28.63

4

CURRENT DATE: 09-07-2006
CURRENT TIME: 16:17:10

FILE DATE: 09-07-2006
FILE NAME: 316T2-4B

TAILWATER

***** USER DEFINED CHANNEL CROSS-SECTION FILE NAME: 316T2-4
 MAIN CHANNEL AND LT & RT OVER BANKS FILE DATE: 09-07-2006
 LEFT CHANNEL BOUNDARY 2
 RIGHT CHANNEL BOUNDARY 5
 MANNING n LEFT OVER BANK 0.050
 MANNING n MAIN CHANNEL 0.038
 MANNING n RIGHT OVER BANK 0.050
 SLOPE OF CHANNEL 0.0104 ft/ft

CROSS-SECTION COORD. NO.	X (ft)	Y (ft)
1	0.00	29.32
2	17.50	28.65
3	23.50	25.57
4	35.50	25.57
5	40.50	28.02
6	58.50	29.30

***** UNIFORM FLOW RATING CURVE FOR DOWNSTREAM CHANNEL

FLOW (cfs)	W.S.E. (ft)	FROUDE NUMBER	DEPTH (ft)	VEL. (f/s)	SHEAR (psf)
0.00	25.57	0.000	0.02	0.00	0.00

3.50	25.81	0.548	0.26	1.50	0.15
5.00	25.86	0.562	0.31	1.67	0.18
10.50	25.99	0.596	0.44	2.13	0.25
14.00	26.06	0.610	0.51	2.35	0.29
17.50	26.13	0.622	0.58	2.53	0.33
21.00	26.19	0.631	0.64	2.69	0.36
24.50	26.24	0.638	0.69	2.84	0.39
28.00	26.30	0.645	0.75	2.97	0.42
31.50	26.35	0.651	0.80	3.09	0.44
35.00	26.40	0.657	0.85	3.20	0.47

Note: Shear stress was calculated using R.

ROADWAY OVERTOPPING DATA

ROADWAY SURFACE	PAVED
EMBANKMENT TOP WIDTH	24.00 ft
CREST LENGTH	10.00 ft
OVERTOPPING CREST ELEVATION	30.54 ft

Station 314+72

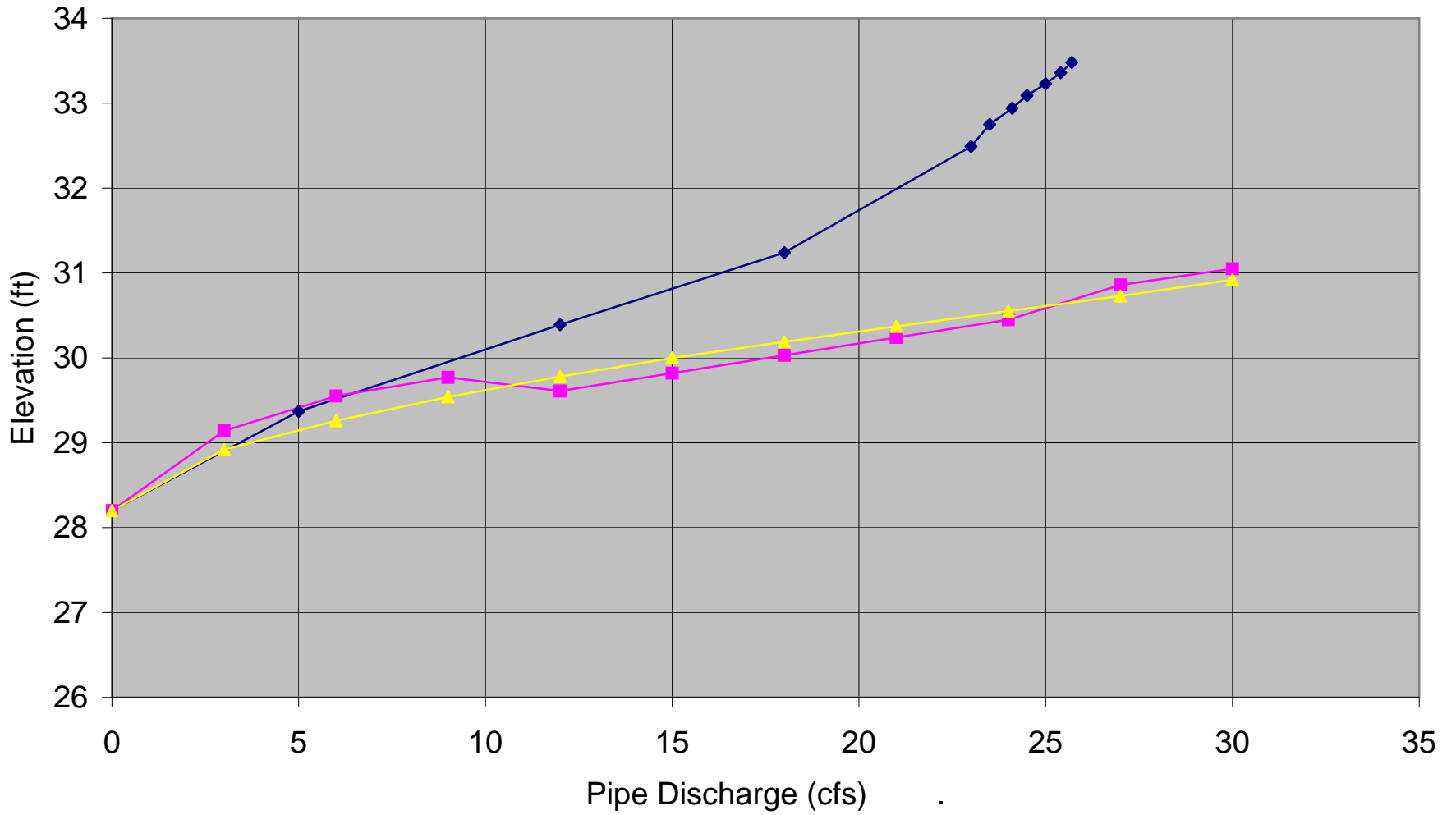

◆ 337+70-Ex ■ 337-T2 3-ft cmp - w. bfls ▲ 337-T2 3-ft cmp no bfls

2009 Alignment Station: 314+72

1 2006 S&HI Station 337+70 Existing conditions

CURRENT DATE: 08-17-2006
CURRENT TIME: 13:50:32

FILE DATE: 08-17-2006
FILE NAME: 33770

FHWA CULVERT ANALYSIS
HY-8, VERSION 6.1

C	SITE DATA			CULVERT SHAPE, MATERIAL, INLET					
U									
L	INLET	OUTLET	CULVERT	BARRELS					
V	ELEV.	ELEV.	LENGTH	SHAPE	SPAN	RISE	MANNING	INLET	
NO.	(ft)	(ft)	(ft)	MATERIAL	(ft)	(ft)	n	TYPE	
1	28.20	27.33	52.01	1 CSP	2.00	2.00	.024	CONVENTIONAL	
2									
3									
4									
5									
6									

SUMMARY OF CULVERT FLOWS (cfs) FILE: 33770 DATE: 08-17-2006

ELEV (ft)	TOTAL	1	2	3	4	5	6	ROADWAY	ITR
28.2	0	0	0	0	0	0	0	0	1
29.37	5	5	0	0	0	0	0	0	1
30.39	12	12	0	0	0	0	0	0	1
31.24	18	18	0	0	0	0	0	0	1
32.49	24	23	0	0	0	0	0	0.82	8
32.75	30	23.5	0	0	0	0	0	6.28	4
32.94	36	24.1	0	0	0	0	0	11.85	4
33.09	42	24.5	0	0	0	0	0	17.2	3
33.23	48	25	0	0	0	0	0	22.79	3
33.36	54	25.4	0	0	0	0	0	28.44	3
33.48	60	25.7	0	0	0	0	0	34.1	3
32.4	22.7	22.7	0	0	0	0	0	0 OVERTOPP	ING

SUMMARY OF ITERATIVE SOLUTION ERRORS FILE: 33770 DATE: 08-17-2006

HEAD	HEAD	TOTAL	FLOW	% FLOW
ELEV (ft)	ERROR (ft)	FLOW (cfs)	ERROR (cfs)	ERROR
28.20	0.000	0.00	0.00	0.00
29.37	0.000	5.00	0.00	0.00
30.39	0.000	12.00	0.00	0.00
31.24	0.000	18.00	0.00	0.00
32.49	-0.007	24.00	0.22	0.92
32.75	-0.006	30.00	0.25	0.83

32.94	-0.009	36.00	0.09	0.25
33.09	-0.005	42.00	0.26	0.62
33.23	-0.004	48.00	0.23	0.48
33.36	-0.003	54.00	0.19	0.35
33.48	-0.003	60.00	0.16	0.27

<1> TOLERANCE (ft) = 0.010

<2> TOLERANCE (%) = 1.000

2

CURRENT DATE: 08-17-2006
CURRENT TIME: 13:50:32

FILE DATE: 08-17-2006
FILE NAME: 33770

PERFORMANCE CURVE FOR CULVERT 1 - 1(2.00 (ft) BY 2.00 (ft)) CSP

DIS-CHARGE FLOW (cfs)	HEAD-WATER ELEV. (ft)	INLET CONTROL DEPTH (ft)	OUTLET CONTROL DEPTH (ft)	FLOW TYPE <F4>	NORMAL DEPTH (ft)	CRIT. DEPTH (ft)	OUTLET DEPTH (ft)	TW DEPTH (ft)	OUTLET VEL. (fps)
0	28.2	0	0	0-NF	0	0	0	-0.05	0
5	29.37	1.17	1.17	1-S2n	0.77	0.79	0.69	0.23	5.23
12	30.39	2.08	2.19	2-M2c	1.3	1.24	1.24	0.36	5.85
18	31.24	3.04	2.88	2-M2c	2	1.52	1.52	0.46	7.03
22.96	32.49	4.12	4.29	2-M2c	2	1.69	1.69	0.54	8.13
23.47	32.75	4.25	4.55	2-M2c	2	1.71	1.71	0.61	8.25
24.06	32.93	4.4	4.73	2-M2c	2	1.72	1.72	0.68	8.38
24.54	33.08	4.53	4.88	2-M2c	2	1.74	1.74	0.74	8.49
24.98	33.23	4.65	5.03	2-M2c	2	1.75	1.75	0.8	8.59
25.37	33.35	4.76	5.15	2-M2c	2	1.76	1.76	0.85	8.67
25.74	33.47	4.87	5.27	2-M2c	2	1.77	1.77	0.91	8.75

El. inlet face invert 28.20 ft El. outlet invert 27.33 ft
El. inlet throat invert 0.00 ft El. inlet crest 0.00 ft

***** SITE DATA ***** CULVERT INVERT *****

INLET STATION 0.00 ft
INLET ELEVATION 28.20 ft
OUTLET STATION 52.00 ft
OUTLET ELEVATION 27.33 ft
NUMBER OF BARRELS 1
SLOPE (V/H) 0.0167
CULVERT LENGTH ALONG SLOPE 52.01 ft

***** CULVERT DATA SUMMARY *****

BARREL SHAPE CIRCULAR
BARREL DIAMETER 2.00 ft
BARREL MATERIAL CORRUGATED STEEL
BARREL MANNING'S n 0.024
INLET TYPE CONVENTIONAL

INLET EDGE AND WALL THIN EDGE PROJECTING
INLET DEPRESSION NONE

3

CURRENT DATE: 08-17-2006
CURRENT TIME: 13:50:32

FILE DATE: 08-17-2006
FILE NAME: 33770

TAILWATER

***** USER DEFINED CHANNEL CROSS-SECTION FILE NAME: 33770-TW
MAIN CHANNEL ONLY FILE DATE: 08-17-2006
LEFT CHANNEL BOUNDARY 0
RIGHT CHANNEL BOUNDARY 0
MANNING n LEFT OVER BANK 0.000
MANNING n MAIN CHANNEL 0.040
MANNING n RIGHT OVER BANK 0.000
SLOPE OF CHANNEL 0.0290 ft/ft

CROSS-SECTION	X	Y
COORD. NO.	(ft)	(ft)
1	0.00	31.19
2	7.00	27.36
3	17.20	27.28
4	30.20	31.04

***** UNIFORM FLOW RATING CURVE FOR DOWNSTREAM CHANNEL

FLOW	W.S.E.	FROUDE	DEPTH	VEL.	SHEAR
(cfs)	(ft)	NUMBER	(ft)	(f/s)	(psf)
0.00	27.28	0.000	-0.05	0.00	0.00
5.00	27.56	0.865	0.23	2.32	0.40
12.00	27.69	0.926	0.36	3.08	0.62
18.00	27.79	0.957	0.46	3.54	0.76
24.00	27.87	0.979	0.54	3.88	0.87
30.00	27.94	0.996	0.61	4.18	0.97
36.00	28.01	1.011	0.68	4.44	1.07
42.00	28.07	1.023	0.74	4.67	1.15
48.00	28.13	1.033	0.80	4.88	1.22
54.00	28.18	1.043	0.85	5.06	1.29
60.00	28.24	1.051	0.91	5.24	1.36

Note: Shear stress was calculated using R.

ROADWAY OVERTOPPING DATA

ROADWAY SURFACE

PAVED

EMBANKMENT TOP WIDTH	24.00 ft
CREST LENGTH	10.00 ft
OVERTOPPING CREST ELEVATION	32.40 ft

2009 Alignment Station: 314+72
 2006 S&H Station 337+70 Tier 2 FISH PASS design

non-baffle design: Juvenile Coho

C:\Client\ALASKA-1\ADFGFI-1\fishpass.exe

Help Print Status Backwater Inlet CalcMode cOrrugations

Weak Swimming Fish Passage

Length Fish (mm)	Culvert (ft)	Slope (%)	Manning n Wall	Manning n Bed	Q (cfs)	Culvert Diam. (ft)	Bed (ft)	Depth Outlet (ft)
96	52	1.7	.024	.024	2.7	3	1	1.5

Calculated Fish Parameters

--- Fish Passage --- Possible Energy (joules)

Allowable Uel.	Min. Flow Depth	Possible Power	Outlet	Inlet
4.5 ft/sec	0.21 ft	0.42 watts	0.77	0.77

Calculated Flow Parameters

Avg., cross-section, water velocity (ft/sec)	Normal Flow		Critical Flow
	Depth (ft)	Velocity (ft/sec)	Depth (ft)
	0.29	3.18	0.30
			3.08

Fish power required in outlet zone (watts)
 Fish energy required in outlet zone (joules)
 Fish power required at inlet (watts) 0.04
 Fish energy required at inlet (joules) 0.08

Acceptable Design
 Alt = Menu <F1 = Current Field Help> <Esc = Exit>

adult coho - 600mm

C:\Client\ALASKA-1\ADFGFI-1\fishpass.exe

Help Print Status Backwater Inlet CalcMode cOrrugations

Weak Swimming Fish Passage

Length Fish (mm)	Culvert (ft)	Slope (%)	Manning n Wall	Manning n Bed	Q (cfs)	Culvert Diam. (ft)	Bed (ft)	Depth Outlet (ft)
600	52	1.7	.024	.024	2.7	3	1	1.5

Calculated Fish Parameters

--- Fish Passage --- Possible Energy (joules)

Allowable Uel.	Min. Flow Depth	Possible Power	Outlet	Inlet
6.1 ft/sec	0.15 ft	38.11 watts	187.50	187.50

Calculated Flow Parameters

Avg., cross-section, water velocity (ft/sec)	Normal Flow		Critical Flow
	Depth (ft)	Velocity (ft/sec)	Depth (ft)
	0.29	3.18	0.30
			3.08

Fish power required in outlet zone (watts)
 Fish energy required in outlet zone (joules)
 Fish power required at inlet (watts) 1.46
 Fish energy required at inlet (joules) 2.92

Acceptable Design
 Alt = Menu <F1 = Current Field Help> <Esc = Exit>

Adult coho - adjusted to 'equivalent' grayling

C:\Client\ALASKA-1\ADFGFI-1\fishpass.exe

Help Print Status Backwater Inlet CalcMode cOrrugations

Weak Swimming Fish Passage

Length Fish (mm)	Culvert (ft)	Slope (%)	Manning n Wall	Manning n Bed	Q (cfs)	Culvert Diam. (ft)	Bed (ft)	Depth Outlet (ft)
942	52	1.7	.024	.024	2.7	3	1	1.5

Calculated Fish Parameters

--- Fish Passage --- Possible Energy (joules)

Allowable Uel.	Min. Flow Depth	Possible Power	Outlet	Inlet
6.3 ft/sec	0.15 ft	115.59 watts	725.60	725.60

Calculated Flow Parameters

Avg., cross-section, water velocity (ft/sec)	Normal Flow		Critical Flow
	Depth (ft)	Velocity (ft/sec)	Depth (ft)
	0.29	3.18	0.30
			3.08

Fish power required in outlet zone (watts)
 Fish energy required in outlet zone (joules)
 Fish power required at inlet (watts) 4.01
 Fish energy required at inlet (joules) 8.01

Acceptable Design
 Alt = Menu <F1 = Current Field Help> <Esc = Exit>

2009 Alignment Station: 314+72

1 2006 S&HI Station 337+70 Tier 2 fish passage - 3-ft CMP

CURRENT DATE: 09-07-2006
 CURRENT TIME: 16:53:01

FILE DATE: 09-07-2006
 FILE NAME: 337T2-3

FHWA CULVERT ANALYSIS
 HY-8, VERSION 6.1

C	SITE DATA			CULVERT SHAPE, MATERIAL, INLET					
U									
L	INLET	OUTLET	CULVERT	BARRELS					
V	ELEV.	ELEV.	LENGTH	SHAPE	SPAN	RISE	MANNING	INLET	
NO.	(ft)	(ft)	(ft)	MATERIAL	(ft)	(ft)	n	TYPE	
1	28.20	27.33	52.01	1 CSP	3.00	3.00	.024	CONVENTIONAL	
2									
3									
4									
5									
6									

SUMMARY OF CULVERT FLOWS (cfs) FILE: 337T2-3 DATE: 09-07-2006

ELEV (ft)	TOTAL	1	2	3	4	5	6	ROADWA' ITR
28.2	0	0	0	0	0	0	0	0 1
28.92	3	3	0	0	0	0	0	0 1
29.26	6	6	0	0	0	0	0	0 1
29.54	9	9	0	0	0	0	0	0 1
29.78	12	12	0	0	0	0	0	0 1
30	15	15	0	0	0	0	0	0 1
30.19	18	18	0	0	0	0	0	0 1
30.37	21	21	0	0	0	0	0	0 1
30.55	24	24	0	0	0	0	0	0 1
30.73	27	27	0	0	0	0	0	0 1
30.92	30	30	0	0	0	0	0	0 1
32.4	48.5	48.5	0	0	0	0	0	0 OVERTOFING

SUMMARY OF ITERATIVE SOLUTION ERRORS FILE: 337T2-3 DATE: 09-07-2006

HEAD	HEAD	TOTAL	FLOW	% FLOW
ELEV (ft)	ERROR (ft)	FLOW (cfs)	ERROR (cfs)	ERROR
28.20	0.000	0.00	0.00	0.00
28.92	0.000	3.00	0.00	0.00
29.26	0.000	6.00	0.00	0.00
29.54	0.000	9.00	0.00	0.00
29.78	0.000	12.00	0.00	0.00
30.00	0.000	15.00	0.00	0.00

30.19	0.000	18.00	0.00	0.00
30.37	0.000	21.00	0.00	0.00
30.55	0.000	24.00	0.00	0.00
30.73	0.000	27.00	0.00	0.00
30.92	0.000	30.00	0.00	0.00

<1> TOLERANCE (ft) = 0.010

<2> TOLERANCE (%) = 1.000

2

CURRENT DATE: 09-07-2006
CURRENT TIME: 16:53:01

FILE DATE: 09-07-2006
FILE NAME: 337T2-3

PERFORMANCE CURVE FOR CULVERT 1 - 1(3.00 (ft) BY 3.00 (ft)) CSP

DIS- HEAD- INLET OUTLET
CHARGE WATER CONTROL CONTROL FLOW NORMAL CRIT. OUTLET TW OUTLET TW
FLOW ELEV. DEPTH DEPTH TYPE DEPTH DEPTH DEPTH DEPTH VEL. VEL.
(cfs) (ft) (ft) (ft) <F4> (ft) (ft) (ft) (ft) (fps) (fps)

0.00	28.20	0.00	0.00	0-NF	0.00	0.00	0.00	-0.05	0.00	0.00
3.00	28.92	0.72	0.72	1-S2n	0.49	0.52	0.42	0.17	4.75	2.07
6.00	29.26	1.06	1.06	1-S2n	0.71	0.76	0.66	0.24	5.22	2.55
9.00	29.54	1.34	1.34	1-S2n	0.89	0.94	0.88	0.30	5.18	2.91
12.00	29.78	1.58	1.58	1-S2n	1.03	1.09	1.03	0.35	5.56	3.20
15.00	30.00	1.80	1.80	1-S2n	1.17	1.23	1.03	0.40	6.95	3.45
18.00	30.19	1.99	1.99	1-S2n	1.29	1.35	1.15	0.44	7.20	3.66
21.00	30.37	2.17	2.17	1-S2n	1.41	1.47	1.27	0.48	7.37	3.86
24.00	30.55	2.35	2.35	1-S2n	1.52	1.57	1.47	0.52	6.94	4.04
27.00	30.73	2.53	2.53	1-S2n	1.63	1.67	1.57	0.56	7.20	4.20
30.00	30.92	2.72	2.72	1-S2n	1.75	1.77	1.67	0.59	7.41	4.35

El. inlet face invert 28.20 ft El. outlet invert 27.33 ft
El. inlet throat invert 0.00 ft El. inlet crest 0.00 ft

***** SITE DATA ***** CULVERT INVERT *****

INLET STATION 0.00 ft
INLET ELEVATION 28.20 ft
OUTLET STATION 52.00 ft
OUTLET ELEVATION 27.33 ft
NUMBER OF BARRELS 1
SLOPE (V/H) 0.0167
CULVERT LENGTH ALONG SLOPE 52.01 ft

***** CULVERT DATA SUMMARY *****

BARREL SHAPE CIRCULAR
BARREL DIAMETER 3.00 ft
BARREL MATERIAL CORRUGATED STEEL
BARREL MANNING'S n 0.024
INLET TYPE CONVENTIONAL

INLET EDGE AND WALL MITERED TO CONFORM TO SLOPE
INLET DEPRESSION NONE

3

CURRENT DATE: 09-07-2006
CURRENT TIME: 16:53:01

FILE DATE: 09-07-2006
FILE NAME: 337T2-3

TAILWATER

***** USER DEFINED CHANNEL CROSS-SECTION FILE NAME: 337T2-3
MAIN CHANNEL ONLY FILE DATE: 09-07-2006
LEFT CHANNEL BOUNDARY 0
RIGHT CHANNEL BOUNDARY 0
MANNING n LEFT OVER BANK 0.000
MANNING n MAIN CHANNEL 0.038
MANNING n RIGHT OVER BANK 0.000
SLOPE OF CHANNEL 0.0294 ft/ft

CROSS-SECTION	X	Y
COORD. NO.	(ft)	(ft)
1	0.00	31.19
2	7.00	27.36
3	17.20	27.28
4	30.20	31.04

***** UNIFORM FLOW RATING CURVE FOR DOWNSTREAM CHANNEL

FLOW	W.S.E.	FROUDE	DEPTH	VEL.	SHEAR
(cfs)	(ft)	NUMBER	(ft)	(f/s)	(psf)
0.00	27.28	0.000	-0.05	0.00	0.00
3.00	27.50	0.878	0.17	2.07	0.31
6.00	27.57	0.924	0.24	2.55	0.43
9.00	27.63	0.954	0.30	2.91	0.52
12.00	27.68	0.977	0.35	3.20	0.61
15.00	27.73	0.994	0.40	3.45	0.68
18.00	27.77	1.009	0.44	3.66	0.74
21.00	27.81	1.022	0.48	3.86	0.80
24.00	27.85	1.033	0.52	4.04	0.86
27.00	27.89	1.043	0.56	4.20	0.91
30.00	27.92	1.051	0.59	4.35	0.96

Note: Shear stress was calculated using R.

ROADWAY OVERTOPPING DATA

ROADWAY SURFACE

PAVED

EMBANKMENT TOP WIDTH	24.00 ft
CREST LENGTH	10.00 ft
OVERTOPPING CREST ELEVATION	32.40 ft

366+36

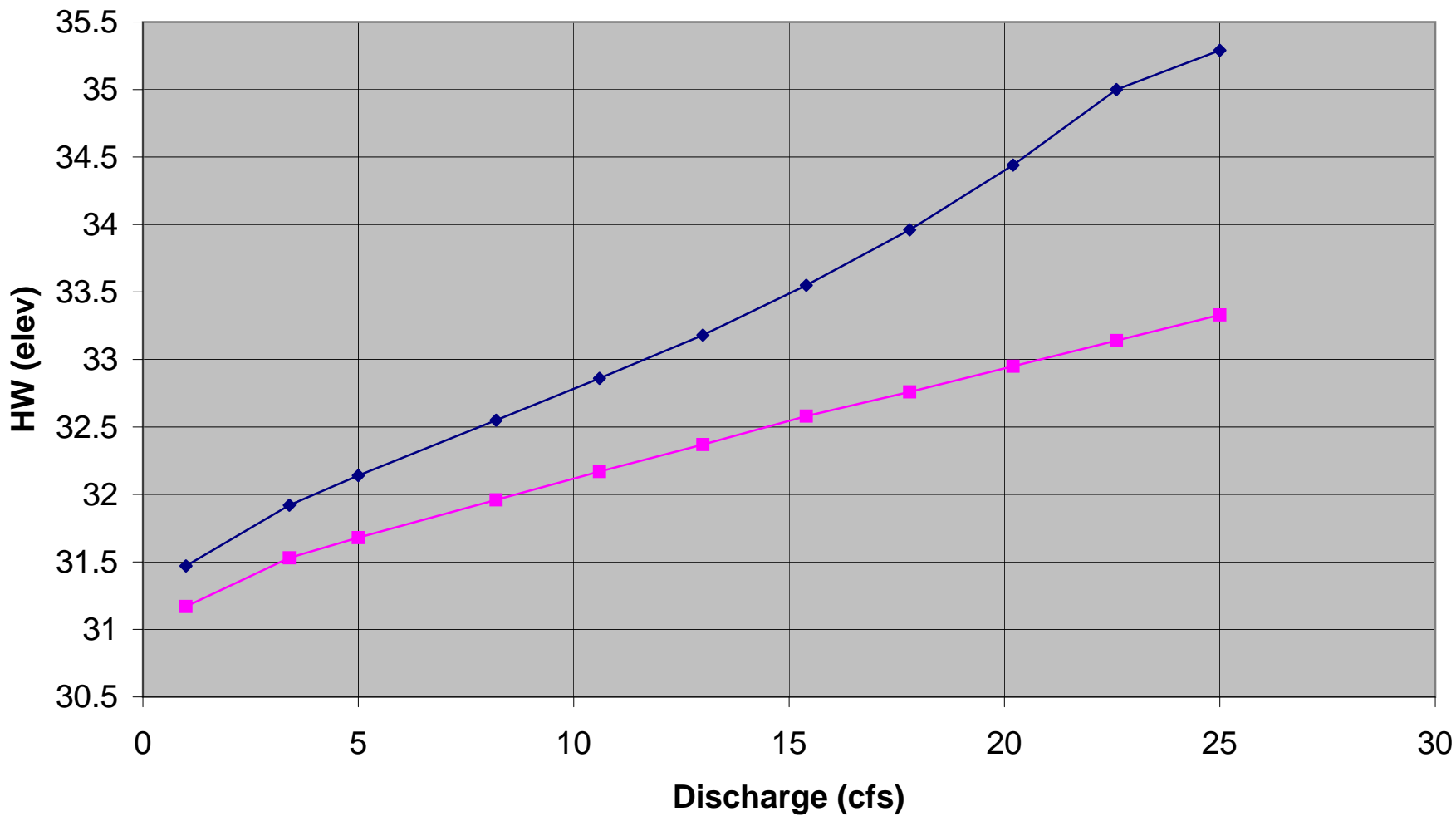

—◆— 393-50 Ex —■— 393-50 T1

HY-8 Culvert Analysis Report

2009 Alignment Station 366+36
Existing conditions

Table 1 - Summary of Culvert Flows at Crossing: 39350-ex

Headwater Elevation (ft)	Total Discharge (cfs)	Culvert 1 Discharge (cfs)	Roadway Discharge (cfs)	Iterations
31.47	1.00	1.00	0.00	1
31.92	3.40	3.40	0.00	1
32.14	5.00	5.00	0.00	1
32.55	8.20	8.20	0.00	1
32.86	10.60	10.60	0.00	1
33.18	13.00	13.00	0.00	1
33.55	15.40	15.40	0.00	1
33.96	17.80	17.80	0.00	1
34.44	20.20	20.20	0.00	1
35.00	22.60	22.60	0.00	1
35.29	25.00	23.78	1.09	18

Table 2 - Culvert Summary Table: Culvert 1

Total Discharge (cfs)	Culvert Discharge (cfs)	Headwater Elevation (ft)	Inlet Control Depth (ft)	Outlet Control Depth (ft)	Flow Type	Normal Depth (ft)	Critical Depth (ft)	Outlet Depth (ft)	Tailwater Depth (ft)	Outlet Velocity (ft/s)	Tailwater Velocity (ft/s)
1.00	1.00	31.47	0.488	0.000	1-S2n	0.276	0.332	0.282	0.128	3.581	1.886
3.40	3.40	31.92	0.938	0.000	1-S2n	0.528	0.640	0.530	0.269	5.057	2.956
5.00	5.00	32.14	1.160	0.000	1-S2n	0.649	0.786	0.655	0.340	5.571	3.385
8.20	8.20	32.55	1.575	0.000	1-S2n	0.850	1.018	0.852	0.456	6.420	4.038
10.60	10.60	32.86	1.879	0.000	1-S2n	0.986	1.164	0.987	0.532	6.857	4.396
13.00	13.00	33.18	2.204	0.000	5-S2n	1.115	1.293	1.122	0.600	7.171	4.707
15.40	15.40	33.55	2.567	0.000	5-S2n	1.246	1.413	1.246	0.664	7.481	4.975
17.80	17.80	33.96	2.983	0.000	5-S2n	1.379	1.514	1.383	0.724	7.683	5.208
20.20	20.20	34.44	3.463	0.000	5-S2n	1.533	1.611	1.535	0.779	7.825	5.422
22.60	22.60	35.00	4.016	3.511	2-M2c	1.744	1.681	1.681	0.832	8.043	5.623
25.00	23.78	35.29	4.314	3.860	7-M2c	2.000	1.716	1.716	0.882	8.316	5.802

 Inlet Elevation (invert):
 30.98 ft, Outlet Elevation
 (invert): 29.23 ft
 Culvert Length: 56.03 ft,
 Culvert Slope: 0.0313

Site Data - Culvert 1

Site Data Option: Culvert Invert Data
 Inlet Station: 0.00 ft
 Inlet Elevation: 30.98 ft
 Outlet Station: 56.00 ft
 Outlet Elevation: 29.23 ft
 Number of Barrels: 1

Culvert Data Summary - Culvert 1

Barrel Shape: Circular
 Barrel Diameter: 2.00 ft
 Barrel Material: Corrugated Steel
 Barrel Manning's n: 0.0240
 Inlet Type: Conventional
 Inlet Edge Condition: Thin Edge Projecting
 Inlet Depression: None

Table 3 - Downstream Channel Rating Curve (Crossing: 39350-ex)

Flow (cfs)	Water Surface Elev (ft)	Depth (ft)	Velocity (ft/s)	Shear (psf)	Froude Number
1.00	29.36	0.13	1.89	0.30	0.94
3.40	29.50	0.27	2.96	0.64	1.03
5.00	29.57	0.34	3.39	0.81	1.06
8.20	29.69	0.46	4.04	1.08	1.11
10.60	29.76	0.53	4.40	1.26	1.12
13.00	29.83	0.60	4.71	1.42	1.14
15.40	29.89	0.66	4.97	1.57	1.15
17.80	29.95	0.72	5.21	1.72	1.16
20.20	30.01	0.78	5.42	1.85	1.17
22.60	30.06	0.83	5.62	1.97	1.18
25.00	30.11	0.88	5.80	2.09	1.18

Tailwater Channel Data - 39350-ex

Tailwater Channel Option: Trapezoidal Channel

Bottom Width: 4.00 ft

Side Slope (H:V): 1.00 (1:1)

Channel Slope: 0.0380

Channel Manning's n: 0.0380

Channel Invert Elevation: 29.23 ft

Roadway Data for Crossing: 39350-ex

Roadway Profile Shape: Constant Roadway Elevation

Crest Length: 100.00 ft

Crest Elevation: 35.27 ft

Roadway Surface: Paved

Roadway Top Width: 28.00 ft

HY-8 Culvert Analysis Report

2009 Alignment Station 366+36
Tier 1 Fish Passage

42"x29" pipe arch
20-percent fill with substrate modeled with user defined coordinates

Table 1 - Summary of Culvert Flows at Crossing: 39350-T1user

Headwater Elevation (ft)	Total Discharge (cfs)	Culvert 1 Discharge (cfs)	Roadway Discharge (cfs)	Iterations
31.17	1.00	1.00	0.00	1
31.53	3.40	3.40	0.00	1
31.68	5.00	5.00	0.00	1
31.96	8.20	8.20	0.00	1
32.17	10.60	10.60	0.00	1
32.37	13.00	13.00	0.00	1
32.58	15.40	15.40	0.00	1
32.76	17.80	17.80	0.00	1
32.95	20.20	20.20	0.00	1
33.14	22.60	22.60	0.00	1
33.33	25.00	25.00	0.00	1

Table 2 - Culvert Summary Table: Culvert 1

Total Discharge (cfs)	Culvert Discharge (cfs)	Headwater Elevation (ft)	Inlet Control Depth (ft)	Outlet Control Depth (ft)	Flow Type	Normal Depth (ft)	Critical Depth (ft)	Outlet Depth (ft)	Tailwater Depth (ft)	Outlet Velocity (ft/s)	Tailwater Velocity (ft/s)
1.00	1.00	31.17	0.190	0.190	1-S2n	0.087	0.121	0.090	0.128	2.178	1.886
3.40	3.40	31.53	0.549	0.549	1-S2n	0.246	0.311	0.250	0.269	4.079	2.956
5.00	5.00	31.68	0.704	0.704	1-S2n	0.315	0.410	0.324	0.340	4.618	3.385
8.20	8.20	31.96	0.980	0.980	1-S2n	0.440	0.567	0.446	0.456	5.483	4.038
10.60	10.60	32.17	1.186	1.186	1-S2n	0.522	0.670	0.529	0.532	5.973	4.396
13.00	13.00	32.37	1.392	0.000	1-S2n	0.602	0.769	0.602	0.600	6.433	4.707
15.40	15.40	32.58	1.596	0.000	1-S2n	0.675	0.856	0.675	0.664	6.816	4.975
17.80	17.80	32.76	1.783	0.000	1-S2n	0.748	0.940	0.749	0.724	7.114	5.208
20.20	20.20	32.95	1.970	0.000	5-S2n	0.821	1.020	0.821	0.779	7.378	5.422
22.60	22.60	33.14	2.158	0.000	5-S2n	0.893	1.097	0.896	0.832	7.616	5.623
25.00	25.00	33.33	2.351	0.000	5-S2n	0.966	1.173	0.967	0.882	7.835	5.802

 Inlet Elevation (invert):
 30.98 ft, Outlet Elevation
 (invert): 29.23 ft
 Culvert Length: 56.03 ft,
 Culvert Slope: 0.0313

Site Data -

Culvert 1

Site Data Option: Culvert Invert Data
 Inlet Station: 0.00 ft
 Inlet Elevation: 30.98 ft
 Outlet Station: 56.00 ft
 Outlet Elevation: 29.23 ft
 Number of Barrels: 1

Culvert Data Summary - Culvert 1

Barrel Shape: User Defined
 Barrel Span: 3.42 ft
 Barrel Rise: 1.97 ft
 Barrel Material: Corrugated Metal Riveted or Welded
 Barrel Manning's n: 0.0240 (top and sides)
 Manning's n: 1.4lf (bottom)
 Inlet Type: Conventional
 Inlet Edge Condition: Thin Edge Projecting
 Inlet Depression: None

Table 3 - Downstream Channel Rating Curve (Crossing: 39350-T1user)

Flow (cfs)	Water Surface Elev (ft)	Depth (ft)	Velocity (ft/s)	Shear (psf)	Froude Number
1.00	29.36	0.13	1.89	0.30	0.94
3.40	29.50	0.27	2.96	0.64	1.03
5.00	29.57	0.34	3.39	0.81	1.06
8.20	29.69	0.46	4.04	1.08	1.11
10.60	29.76	0.53	4.40	1.26	1.12
13.00	29.83	0.60	4.71	1.42	1.14
15.40	29.89	0.66	4.97	1.57	1.15
17.80	29.95	0.72	5.21	1.72	1.16
20.20	30.01	0.78	5.42	1.85	1.17
22.60	30.06	0.83	5.62	1.97	1.18
25.00	30.11	0.88	5.80	2.09	1.18

Tailwater Channel Data - 39350-T1user

Tailwater Channel Option: Trapezoidal Channel

Bottom Width: 4.00 ft

Side Slope (H:V): 1.00 (1:1)

Channel Slope: 0.0380

Channel Manning's n: 0.0380

Channel Invert Elevation: 29.23 ft

Roadway Data for Crossing: 39350-T1user

Roadway Profile Shape: Constant Roadway Elevation

Crest Length: 100.00 ft

Crest Elevation: 35.27 ft

Roadway Surface: Paved

Roadway Top Width: 28.00 ft

HY-8 Culvert Analysis Report

2009 Alignment Station 382+07
Existing conditions

Table 1 - Summary of Culvert Flows at Crossing: 409-25ex

Headwater Elevation (ft)	Total Discharge (cfs)	Culvert 1 Discharge (cfs)	Roadway Discharge (cfs)	Iterations
31.12	1.00	1.00	0.00	1
31.94	6.90	6.90	0.00	1
32.47	12.80	12.80	0.00	1
32.94	18.70	18.70	0.00	1
33.03	20.00	20.00	0.00	1
33.80	30.50	30.50	0.00	1
34.29	36.40	36.40	0.00	1
34.89	42.30	42.30	0.00	1
35.57	48.20	48.20	0.00	1
36.29	54.10	54.10	0.00	1
36.67	60.00	57.08	2.77	16

Table 2 - Culvert Summary Table: Culvert 1

Total Discharge (cfs)	Culvert Discharge (cfs)	Headwater Elevation (ft)	Inlet Control Depth (ft)	Outlet Control Depth (ft)	Flow Type	Normal Depth (ft)	Critical Depth (ft)	Outlet Depth (ft)	Tailwater Depth (ft)	Outlet Velocity (ft/s)	Tailwater Velocity (ft/s)
1.00	1.00	31.12	0.461	0.616	3-M2t	0.705	0.306	0.530	3.000	1.166	0.000
6.90	6.90	31.94	1.224	1.437	2-M2c	2.163	0.816	0.816	3.000	4.408	0.000
12.80	12.80	32.47	1.713	1.972	2-M2c	3.000	1.131	1.131	3.000	5.242	0.000
18.70	18.70	32.94	2.139	2.437	2-M2c	3.000	1.378	1.378	3.000	5.896	0.000
20.00	20.00	33.03	2.230	2.528	2-M2c	3.000	1.430	1.430	3.000	6.014	0.000
30.50	30.50	33.80	2.957	3.295	2-M2c	3.000	1.789	1.789	3.000	6.940	0.000
36.40	36.40	34.29	3.397	3.791	7-M2c	3.000	1.955	1.955	3.000	7.472	0.000
42.30	42.30	34.89	3.885	4.395	7-M2c	3.000	2.117	2.117	3.000	7.933	0.000
48.20	48.20	35.57	4.436	5.070	7-M2c	3.000	2.252	2.252	3.000	8.489	0.000
54.10	54.10	36.29	5.062	5.792	7-M2c	3.000	2.387	2.387	3.000	8.974	0.000
60.00	57.08	36.67	5.410	6.175	7-M2c	3.000	2.439	2.439	3.000	9.263	0.000

 Inlet Elevation (invert):
 30.50 ft, Outlet Elevation
 (invert): 30.47 ft
 Culvert Length: 62.00 ft,
 Culvert Slope: 0.0005

**Site Data -
 Culvert 1**
 Site Data Option:
 Culvert Invert Data
 Inlet Station: 0.00 ft

Inlet Elevation: 30.50 ft
 Outlet Station: 62.00 ft
 Outlet Elevation: 30.47 ft
 Number of Barrels: 1

Culvert Data Summary - Culvert 1

Barrel Shape: Circular
 Barrel Diameter: 3.00 ft
 Barrel Material: Corrugated Steel
 Barrel Manning's n: 0.0240
 Inlet Type: Conventional
 Inlet Edge Condition: Thin Edge Projecting
 Inlet Depression: None

Table 3 - Downstream Channel Rating Curve (Crossing: 409-25ex)

Flow (cfs)	Water Surface Elev (ft)	Depth (ft)
1.00	31.00	3.00
6.90	31.00	3.00
12.80	31.00	3.00
18.70	31.00	3.00
20.00	31.00	3.00
30.50	31.00	3.00
36.40	31.00	3.00
42.30	31.00	3.00
48.20	31.00	3.00
54.10	31.00	3.00
60.00	31.00	3.00

Tailwater Channel Data - 409-25ex

Tailwater Channel Option: Enter Constant Tailwater Elevation

Constant Tailwater Elevation: 31.00 ft

Roadway Data for Crossing: 409-25ex

Roadway Profile Shape: Constant Roadway Elevation

Crest Length: 100.00 ft

Crest Elevation: 36.63 ft

Roadway Surface: Paved

Roadway Top Width: 25.00 ft

2009 Alignment Station: 382+07

2006 S&H Station 405+00 Tier 2 FISH PASS design

non-baffle design: Juvenile Coho

Weak Swimming Fish Passage

Length	Culvert	Slope	Manning n	0	Culvert	Depth
Fish (mm)	(ft)	(%)	Wall	Bed (cfs)	Diam. (ft)	Bed Outlet (ft)
96	62	.5	.02	0	5.2	3 0 .75

Calculated Fish Parameters

--- Fish Passage ---		Possible Energy (joules)	
Allowable Uel.	Min. Flow Depth	Possible Power	Outlet Inlet
4.5 ft/sec	0.66 ft	0.42 watts	0.77 0.77

Calculated Flow Parameters

Avg., cross-section, water velocity (ft/sec)	Depth (ft)	Normal Flow	Critical Flow
		0.84	0.71
	3.23		

Fish power required in outlet zone (watts)
 Fish energy required in outlet zone (joules)
 Fish power required at inlet (watts) 0.19
 Fish energy required at inlet (joules) 0.38

Acceptable Design
 Alt = Menu <F1 = Current Field Help> Esc = Exit

adult coho - 600mm

Weak Swimming Fish Passage

Length	Culvert	Slope	Manning n	0	Culvert	Depth
Fish (mm)	(ft)	(%)	Wall	Bed (cfs)	Diam. (ft)	Bed Outlet (ft)
600	62	.5	.02	0	5.2	3 0 .75

Calculated Fish Parameters

--- Fish Passage ---		Possible Energy (joules)	
Allowable Uel.	Min. Flow Depth	Possible Power	Outlet Inlet
6.3 ft/sec	0.52 ft	38.11 watts	187.50 187.50

Calculated Flow Parameters

Avg., cross-section, water velocity (ft/sec)	Depth (ft)	Normal Flow	Critical Flow
		0.84	0.71
	3.23		

Fish power required in outlet zone (watts)
 Fish energy required in outlet zone (joules)
 Fish power required at inlet (watts) 9.41
 Fish energy required at inlet (joules) 18.83

Acceptable Design
 Alt = Menu <F1 = Current Field Help> <Esc = Exit>

Adult coho - adjusted to 'equivalent' graying

Weak Swimming Fish Passage

Length	Culvert	Slope	Manning n	0	Culvert	Depth
Fish (mm)	(ft)	(%)	Wall	Bed (cfs)	Diam. (ft)	Bed Outlet (ft)
942	62	.5	.02	0	5.2	3 0 .75

Calculated Fish Parameters

--- Fish Passage ---		Possible Energy (joules)	
Allowable Uel.	Min. Flow Depth	Possible Power	Outlet Inlet
6.9 ft/sec	0.49 ft	115.59 watts	725.60 725.60

Calculated Flow Parameters

Avg., cross-section, water velocity (ft/sec)	Depth (ft)	Normal Flow	Critical Flow
		0.84	0.71
	3.23		

Fish power required in outlet zone (watts)
 Fish energy required in outlet zone (joules)
 Fish power required at inlet (watts) 28.93
 Fish energy required at inlet (joules) 57.86

Acceptable Design
 Alt = Menu <F1 = Current Field Help> <Esc = Exit>

Station 419+95

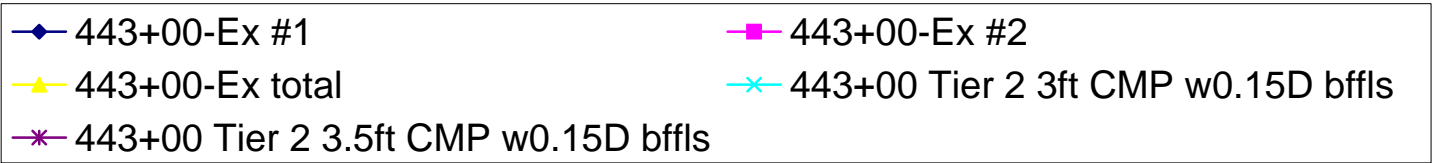
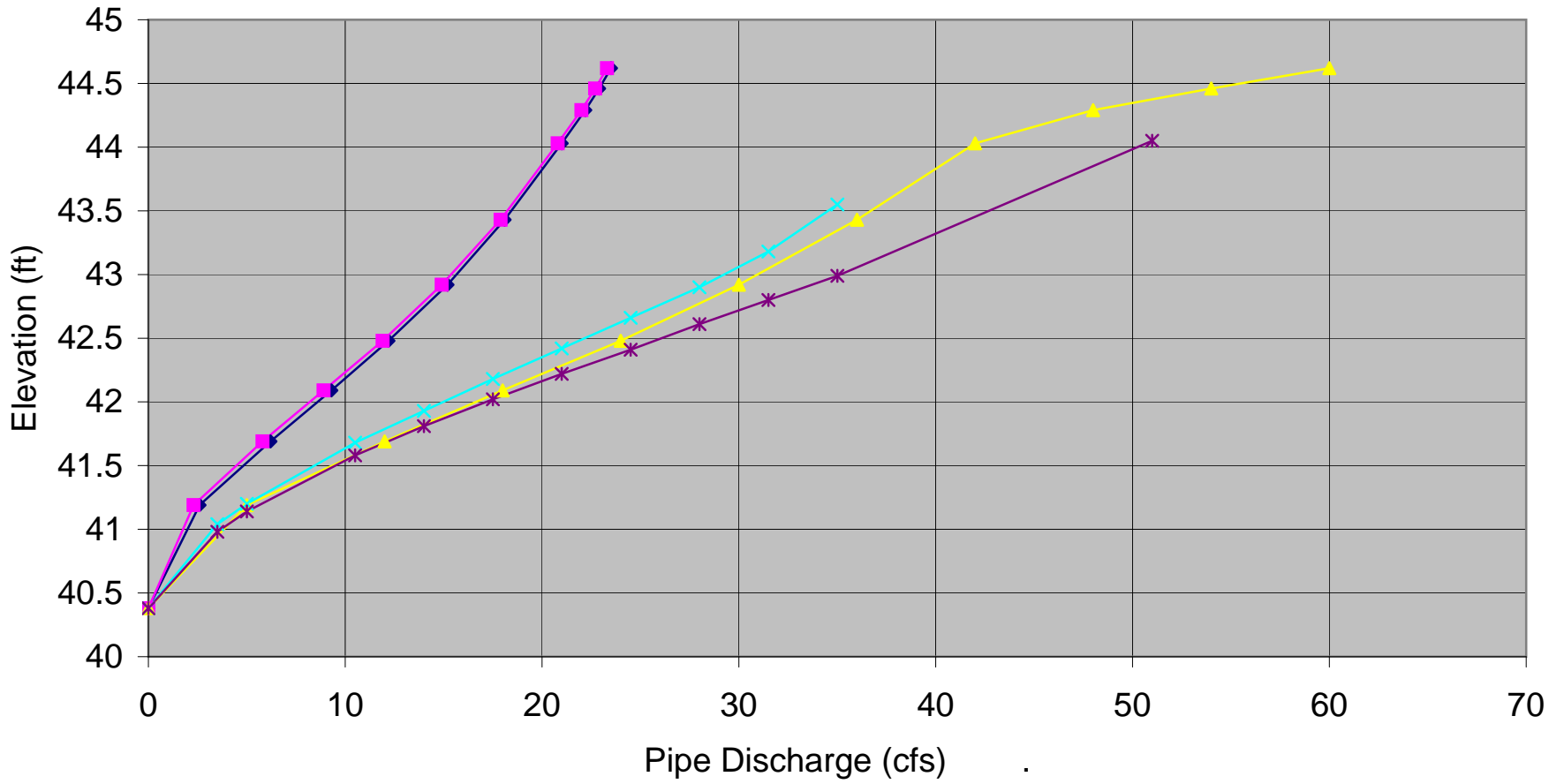

2009 Alignment Station: 419+95

1 2006 S&HI Station 443+00 Existing conditions

CURRENT DATE: 08-17-2006
CURRENT TIME: 14:33:05

FILE DATE: 08-17-2006
FILE NAME: 44300-EX

FHWA CULVERT ANALYSIS
HY-8, VERSION 6.1

C	SITE DATA		CULVERT SHAPE, MATERIAL, INLET					
U								
L	INLET	OUTLET	CULVERT	BARRELS				
V	ELEV.	ELEV.	LENGTH	SHAPE	SPAN	RISE	MANNING	INLET
NO.	(ft)	(ft)	(ft)	MATERIAL	(ft)	(ft)	n	TYPE
1	40.38	38.75	55.17	1 CSP	2.00	2.00	.024	CONVENTIONAL
2	40.43	38.67	55.03	1 CSP	2.00	2.00	.024	CONVENTIONAL
3								
4								
5								
6								

SUMMARY OF CULVERT FLOWS (cfs) FILE: 44300-EX DATE: 08-17-2006

ELEV (ft)	TOTAL	1	2	3	4	5	6 ROADWAY	ITR
40.38	0	0	0	0	0	0	0	0
41.19	5	2.6	2.3	0	0	0	0	4
41.69	12	6.2	5.8	0	0	0	0	3
42.09	18	9.3	8.9	0	0	0	0	2
42.48	24	12.2	11.9	0	0	0	0	3
42.92	30	15.2	14.9	0	0	0	0	3
43.43	36	18.1	17.9	0	0	0	0	3
44.03	42	21	20.8	0	0	0	0	7
44.29	48	22.2	22	0	0	0	3.57	4
44.46	54	22.9	22.7	0	0	0	8.03	3
44.62	60	23.5	23.3	0	0	0	12.92	3
44.05	42	21.1	20.9	0	0	0	0 OVERTOPP	ING

SUMMARY OF ITERATIVE SOLUTION ERRORS FILE: 44300-EX DATE: 08-17-2006

HEAD	HEAD	TOTAL	FLOW	% FLOW
ELEV (ft)	ERROR (ft)	FLOW (cfs)	ERROR (cfs)	ERROR
40.38	0.000	0.00	0.00	0.00
41.19	-0.006	5.00	0.01	0.20
41.69	0.000	12.00	0.00	0.00
42.09	0.008	18.00	-0.13	-0.72
42.48	0.005	24.00	-0.08	-0.33
42.92	0.003	30.00	-0.05	-0.17
43.43	0.002	36.00	-0.03	-0.08
44.03	-0.007	42.00	0.19	0.45
44.29	-0.007	48.00	0.30	0.63
44.46	-0.009	54.00	0.43	0.80
44.62	-0.006	60.00	0.32	0.53

<1> TOLERANCE (ft) = 0.010

<2> TOLERANCE (%) = 1.000

CURRENT DATE: 08-17-2006
 CURRENT TIME: 14:33:05

FILE DATE: 08-17-2006
 FILE NAME: 44300-EX

PERFORMANCE CURVE FOR CULVERT 1 - 1(2.00 (ft) BY 2.00 (ft)) CSP

DIS- CHARGE FLOW (cfs)	HEAD- WATER ELEV. (ft)	INLET CONTROL DEPTH (ft)	OUTLET CONTROL DEPTH (ft)	FLOW TYPE <F4>	NORMAL DEPTH (ft)	CRIT. DEPTH (ft)	OUTLET DEPTH (ft)	TW DEPTH (ft)	OUTLET VEL. (fps)	TW VEL. (fps)
0	40.38	0	0	0 0-NF	0	0	0	-0.6	0	0
2.64	41.2	0.82	0.82	1-S2n	0.47	0.56	0.36	-0.28	6.74	2.24
6.18	41.7	1.32	1.32	1-S2n	0.74	0.88	0.68	-0.14	6.61	2.95
9.25	42.09	1.71	1.71	1-S2n	0.92	1.08	0.92	-0.04	6.53	3.37
12.2	42.47	2.09	2.09	5-S2n	1.09	1.25	1.08	0.04	7.04	3.7
15.17	42.91	2.53	2.53	5-S2n	1.26	1.4	1.2	0.12	7.68	3.97
18.14	43.43	3.05	3.05	5-S2n	1.43	1.53	1.33	0.19	8.2	4.21
21.01	44.02	3.64	3.35	2-M2c	1.64	1.63	1.63	0.25	7.63	4.42
22.16	44.29	3.91	3.45	2-M2c	1.76	1.67	1.67	0.31	7.94	4.61
22.87	44.46	4.08	2.43	2-M2c	2	1.69	1.69	0.36	8.11	4.78
23.47	44.62	4.24	3.48	2-M2c	2	1.71	1.71	0.42	8.25	4.94

El. inlet face invert 40.38 ft El. outlet invert 38.75 ft
 El. inlet throat invert 0.00 ft El. inlet crest 0.00 ft

**** SITE DATA **** CULVERT INVERT *****

INLET STATION 0.00 ft
 INLET ELEVATION 40.38 ft
 OUTLET STATION 55.15 ft
 OUTLET ELEVATION 38.75 ft
 NUMBER OF BARRELS 1
 SLOPE (V/H) 0.0296
 CULVERT LENGTH ALONG SLOPE 55.17 ft

**** CULVERT DATA SUMMARY *****

BARREL SHAPE CIRCULAR
 BARREL DIAMETER 2.00 ft
 BARREL MATERIAL CORRUGATED STEEL
 BARREL MANNING'S n 0.024
 INLET TYPE CONVENTIONAL
 INLET EDGE AND WALL THIN EDGE PROJECTING
 INLET DEPRESSION NONE

CURRENT DATE: 08-17-2006
 CURRENT TIME: 14:33:05

FILE DATE: 08-17-2006
 FILE NAME: 44300-EX

PERFORMANCE CURVE FOR CULVERT 2 - 1(2.00 (ft) BY 2.00 (ft)) CSP

DIS- HEAD- INLET OUTLET
 CHARGE WATER CONTROL CONTROL FLOW NORMAL CRIT. OUTLET TW OUTLET TW

FLOW ELEV. DEPTH DEPTH TYPE DEPTH DEPTH DEPTH DEPTH DEPTH VEL. VEL.
(cfs) (ft) (ft) (ft) <F4> (ft) (ft) (ft) (ft) (fps) (fps)

0.00	40.43	0.00	0.00	0-NF	0.00	0.00	0.00	-0.52	0.00	0.00
2.35	41.20	0.77	0.77	1-S2n	0.44	0.53	0.33	-0.20	6.90	2.24
5.82	41.70	1.27	1.27	1-S2n	0.70	0.85	0.65	-0.06	6.64	2.95
8.88	42.09	1.66	1.66	1-S2n	0.88	1.06	0.76	0.04	8.10	3.37
11.88	42.48	2.05	2.05	5-S2n	1.05	1.24	0.94	0.12	8.24	3.70
14.87	42.91	2.48	2.48	5-S2n	1.21	1.39	1.09	0.20	8.51	3.97
17.89	43.43	3.00	3.00	5-S2n	1.37	1.52	1.32	0.27	8.16	4.21
20.80	44.02	3.59	3.59	5-S2n	1.56	1.63	1.43	0.33	8.66	4.42
21.96	44.29	3.86	3.86	5-S2n	1.65	1.66	1.56	0.39	8.35	4.61
22.67	44.46	4.03	3.60	2-M2c	1.72	1.68	1.68	0.44	8.06	4.78
23.29	44.62	4.19	3.60	2-M2c	1.79	1.70	1.70	0.50	8.20	4.94

El. inlet face invert 40.43 ft El. outlet invert 38.67 ft
El. inlet throat invert 0.00 ft El. inlet crest 0.00 ft

***** SITE DATA ***** CULVERT INVERT *****

INLET STATION 0.00 ft
INLET ELEVATION 40.43 ft
OUTLET STATION 55.00 ft
OUTLET ELEVATION 38.67 ft
NUMBER OF BARRELS 1
SLOPE (V/H) 0.0320
CULVERT LENGTH ALONG SLOPE 55.03 ft

***** CULVERT DATA SUMMARY *****

BARREL SHAPE CIRCULAR
BARREL DIAMETER 2.00 ft
BARREL MATERIAL CORRUGATED STEEL
BARREL MANNING'S n 0.024
INLET TYPE CONVENTIONAL
INLET EDGE AND WALL THIN EDGE PROJECTING
INLET DEPRESSION NONE

4

CURRENT DATE: 08-17-2006
CURRENT TIME: 14:33:05

FILE DATE: 08-17-2006
FILE NAME: 44300-EX

TAILWATER

***** USER DEFINED CHANNEL CROSS-SECTION FILE NAME: 44300-TW

MAIN CHANNEL ONLY FILE DATE: 08-17-2006
LEFT CHANNEL BOUNDARY 0
RIGHT CHANNEL BOUNDARY 0
MANNING n LEFT OVER BANK 0.000
MANNING n MAIN CHANNEL 0.040
MANNING n RIGHT OVER BANK 0.000
SLOPE OF CHANNEL 0.0260 ft/ft

CROSS-SECTION X Y
COORD. NO. (ft) (ft)

1	0.00	41.52
2	7.00	38.15
3	17.20	38.30
4	30.20	41.20

***** UNIFORM FLOW RATING CURVE FOR DOWNSTREAM CHANNEL

FLOW (cfs)	W.S.E. (ft)	FROUDE NUMBER	DEPTH (ft)	VEL. (f/s)	SHEAR (psf)
0.00	38.15	0.000	-0.60	0.00	0.00
5.00	38.47	0.822	-0.28	2.24	0.37
12.00	38.61	0.880	-0.14	2.95	0.56
18.00	38.71	0.909	-0.04	3.37	0.69
24.00	38.79	0.929	0.04	3.70	0.79
30.00	38.87	0.945	0.12	3.97	0.88
36.00	38.94	0.959	0.19	4.21	0.96
42.00	39.00	0.970	0.25	4.42	1.03
48.00	39.06	0.979	0.31	4.61	1.09
54.00	39.11	0.988	0.36	4.78	1.16
60.00	39.17	0.996	0.42	4.94	1.21

Note: Shear stress was calculated using R.

ROADWAY OVERTOPPING DATA

ROADWAY SURFACE	PAVED
EMBANKMENT TOP WIDTH	24.00 ft
CREST LENGTH	10.00 ft
OVERTOPPING CREST ELEVATION	44.05 ft

2009 Alignment Station: 419+95

2006 S&H Station 443+00 Tier 2 FISH PASS design

baffle design: 3.5-ft pipe / Juvenile Coho

Weir Baffle

Weak Swimming Fish Length (mm)	Slope (%)	Manning n Wall	Q Fish (cfs)	Q Flood (cfs)	Culvert Diameter (ft)
96	3	.024	5.3	35	3.5

Calculated Parameters

	.1 x D	.15 x D
Water Velocity in small fish passage zone (ft/sec)	3.85	2.62
Fish power required at weir (watts)	0.21	0.09
Fish power capabilities (watts)	0.26	0.26
Depth of flow over weir (ft)	0.77	0.55
Depth of flow at outlet (ft)	1.12	1.07
Normal Depth at flood flow (ft)	2.16	2.40

Acceptable Design

Alt = Menu <F1 = Current Field Help> <Esc = Exit>

3.5-ft pipe / Adult Coho

Weir Baffle

Weak Swimming Fish Length (mm)	Slope (%)	Manning n Wall	Q Fish (cfs)	Q Flood (cfs)	Culvert Diameter (ft)
600	3	.024	5.3	35	3.5

Calculated Parameters

	.1 x D	.15 x D
Water Velocity in small fish passage zone (ft/sec)	3.85	2.62
Fish power required at weir (watts)	6.31	3.05
Fish power capabilities (watts)	62.55	62.55
Depth of flow over weir (ft)	0.77	0.55
Depth of flow at outlet (ft)	1.12	1.07
Normal Depth at flood flow (ft)	2.16	2.40

Acceptable Design

Alt = Menu <F1 = Current Field Help> <Esc = Exit>

non-baffle design:

Weak Swimming Fish Passage

Length Fish (mm)	Culvert (ft)	Slope (%)	Manning n Wall	Q Bed (cfs)	Q (cfs)	Culvert Diam. (ft)	Bed (ft)	Outlet (ft)	Depth (ft)
96	55	3	.024	0	5.3	3.5	0	0	0

Calculated Fish Parameters

Allowable Uel.	Min. Flow Depth	Possible Power	Outlet	Inlet
4.4 ft/sec	0.64 ft	0.42 watts	0.77	

Calculated Flow Parameters

Depth (ft)	Normal Flow	Critical Flow
0.56	0.56	0.69
5.29	5.29	3.94

Fish power required in outlet zone (watts)
 Fish energy required in outlet zone (joules)
 Fish power required at inlet (watts)
 Fish energy required at inlet (joules)

Normal Flow Supercritical | Normal Depth too Shallow

Alt = Menu <F1 = Current Field Help> <Esc = Exit>

2009 Alignment Station: 419+95

1 2006 S&HI Station 443+00 Tier 2 fish passage - 3.5-ft baffled CMP

CURRENT DATE: 09-05-2006
CURRENT TIME: 17:16:59

FILE DATE: 09-05-2006
FILE NAME: 443T42

FHWA CULVERT ANALYSIS
HY-8, VERSION 6.1

C	SITE DATA		CULVERT SHAPE, MATERIAL, INLET							
U	L	INLET	OUTLET	CULVERT	BARRELS					
V	ELEV.	ELEV.	LENGTH	SHAPE	SPAN	RISE	MANNING	INLET		
NO.	(ft)	(ft)	(ft)	MATERIAL	(ft)	(ft)	n	TYPE		
1	40.38	38.75	55.02	1 ICMP	3.50	2.98	.024	CONVENTIONAL		
2										
3										
4										
5										
6										

SUMMARY OF CULVERT FLOWS (cfs) FILE: 443T42 DATE: 09-05-2006

ELEV (ft)	TOTAL	1	2	3	4	5	6	ROADWAY	ITR
40.38	0	0	0	0	0	0	0	0	1
40.98	3.5	3.5	0	0	0	0	0	0	1
41.14	5	5	0	0	0	0	0	0	1
41.58	10.5	10.5	0	0	0	0	0	0	1
41.81	14	14	0	0	0	0	0	0	1
42.02	17.5	17.5	0	0	0	0	0	0	1
42.22	21	21	0	0	0	0	0	0	1
42.41	24.5	24.5	0	0	0	0	0	0	1
42.61	28	28	0	0	0	0	0	0	1
42.8	31.5	31.5	0	0	0	0	0	0	1
42.99	35	35	0	0	0	0	0	0	1
44.05	51	51	0	0	0	0	0	0 OVERTOPP	ING

SUMMARY OF ITERATIVE SOLUTION ERRORS FILE: 443T42 DATE: 09-05-2006

HEAD	HEAD	TOTAL	FLOW	% FLOW
ELEV (ft)	ERROR (ft)	FLOW (cfs)	ERROR (cfs)	ERROR
40.38	0.000	0.00	0.00	0.00
40.98	0.000	3.50	0.00	0.00
41.14	0.000	5.00	0.00	0.00
41.58	0.000	10.50	0.00	0.00
41.81	0.000	14.00	0.00	0.00
42.02	0.000	17.50	0.00	0.00
42.22	0.000	21.00	0.00	0.00
42.41	0.000	24.50	0.00	0.00
42.61	0.000	28.00	0.00	0.00
42.80	0.000	31.50	0.00	0.00
42.99	0.000	35.00	0.00	0.00

<1> TOLERANCE (ft) = 0.010

<2> TOLERANCE (%) = 1.000

2

CURRENT DATE: 09-05-2006
CURRENT TIME: 17:16:59

FILE DATE: 09-05-2006
FILE NAME: 443T42

PERFORMANCE CURVE FOR CULVERT 1 - 1(3.50 (ft) BY 2.98 (ft)) ICMP

DIS- FLOW (cfs)	HEAD (ft)	INLET (ft)	OUTLET (ft)	CONTROL	CONTROL	FLOW TYPE	NORMAL DEPTH (ft)	CRIT. DEPTH (ft)	OUTLET TW (fps)	OUTLET TW (fps)
0.00	40.38	0.00	0.00	0-NF	0.00	0.00	0.00	-0.60	0.00	0.00
3.50	40.98	0.60	0.60	1-S2n	0.30	0.36	0.16	-0.32	5.38	2.08
5.00	41.14	0.76	0.76	1-S2n	0.36	0.46	0.26	-0.29	6.24	2.31
10.50	41.58	1.20	1.20	1-S2n	0.58	0.74	0.58	-0.17	6.16	2.92
14.00	41.81	1.43	1.43	1-S2n	0.69	0.90	0.60	-0.12	8.02	3.21
17.50	42.02	1.64	1.64	1-S2n	0.80	1.03	0.73	-0.06	8.06	3.45
21.00	42.22	1.84	1.84	1-S2n	0.90	1.16	0.90	-0.01	7.70	3.66
24.50	42.41	2.03	2.03	1-S2n	0.99	1.27	1.00	0.03	7.95	3.85
28.00	42.61	2.23	2.23	1-S2n	1.08	1.37	0.97	0.08	9.40	4.03
31.50	42.80	2.42	2.42	1-S2n	1.17	1.47	1.07	0.12	9.46	4.18
35.00	42.99	2.61	2.61	1-S2n	1.26	1.57	1.17	0.15	9.59	4.32

El. inlet face invert 40.38 ft El. outlet invert 38.75 ft
 El. inlet throat invert 0.00 ft El. inlet crest 0.00 ft

***** SITE DATA ***** CULVERT INVERT *****

INLET STATION 0.00 ft
 INLET ELEVATION 40.38 ft
 OUTLET STATION 55.00 ft
 OUTLET ELEVATION 38.75 ft
 NUMBER OF BARRELS 1
 SLOPE (V/H) 0.0296
 CULVERT LENGTH ALONG SLOPE 55.02 ft

***** CULVERT DATA SUMMARY *****

BARREL SHAPE USER DEFINED
 BARREL SPAN 3.50 ft
 BARREL RISE 2.98 ft
 BARREL MATERIAL STEEL OR ALUMINUM
 BARREL MANNING'S n 0.024 FOR SIDES AND TOP
 0.038 FOR BOTTOM
 INLET TYPE CONVENTIONAL
 INLET EDGE AND WALL MITERED
 INLET DEPRESSION NONE

3

CURRENT DATE: 09-05-2006

FILE DATE: 09-05-2006

CURRENT TIME: 17:16:59

FILE NAME: 443T42

***** USER DEFINED CULVERT CROSS-SECTION - CULVERT # 1

COORDIN X NUMBER (ft)	Y-TOP (ft)	Y-BOTTOM (ft)	Y-BOTTOM (ft)
1	0	41.61	41.61
2	0.17	42.35	40.86
3	0.33	42.63	40.58
4	0.5	42.83	40.38
5	0.81	43.08	40.38
6	1.13	43.24	40.38
7	1.44	43.33	40.38
8	1.75	43.36	40.38
9	2.06	43.33	40.38
10	2.37	43.24	40.38
11	2.69	43.08	40.38
12	3	42.83	40.38
13	3.17	42.63	40.58
14	3.33	42.35	40.86
15	3.5	41.61	41.61

4

CURRENT DATE: 09-05-2006
CURRENT TIME: 17:16:59

FILE DATE: 09-05-2006
FILE NAME: 443T42

TAILWATER

***** USER DEFINED CHANNEL CROSS-SECTION FILE NAME: 443T42BF

MAIN CHANNEL ONLY FILE DATE: 09-05-2006
LEFT CHANNEL BOUNDARY 0
RIGHT CHANNEL BOUNDARY 0
MANNING n LEFT OVER BANK 0.000
MANNING n MAIN CHANNEL 0.038
MANNING n RIGHT OVER BANK 0.000
SLOPE OF CHANNEL 0.0260 ft/ft

CROSS-SECTION COORD. NO.	X (ft)	Y (ft)
1	0.00	41.52
2	7.00	38.15
3	17.20	38.30
4	30.20	41.20

***** UNIFORM FLOW RATING CURVE FOR DOWNSTREAM CHANNEL

FLOW (cfs)	W.S.E. (ft)	FROUDE NUMBER	DEPTH (ft)	VEL. (f/s)	SHEAR (psf)
0.00	38.15	0.000	-0.60	0.00	0.00
3.50	38.43	0.839	-0.32	2.08	0.31
5.00	38.46	0.862	-0.29	2.31	0.36

10.50	38.58	0.912	-0.17	2.92	0.51
14.00	38.63	0.933	-0.12	3.21	0.59
17.50	38.69	0.950	-0.06	3.45	0.66
21.00	38.74	0.964	-0.01	3.66	0.72
24.50	38.78	0.975	0.03	3.85	0.77
28.00	38.83	0.986	0.08	4.03	0.83
31.50	38.87	0.995	0.12	4.18	0.87
35.00	38.90	1.003	0.15	4.32	0.92

Note: Shear stress was calculated using R.

ROADWAY OVERTOPPING DATA

ROADWAY SURFACE	PAVED
EMBANKMENT TOP WIDTH	24.00 ft
CREST LENGTH	10.00 ft
OVERTOPPING CREST ELEVATION	44.05 ft

530+70

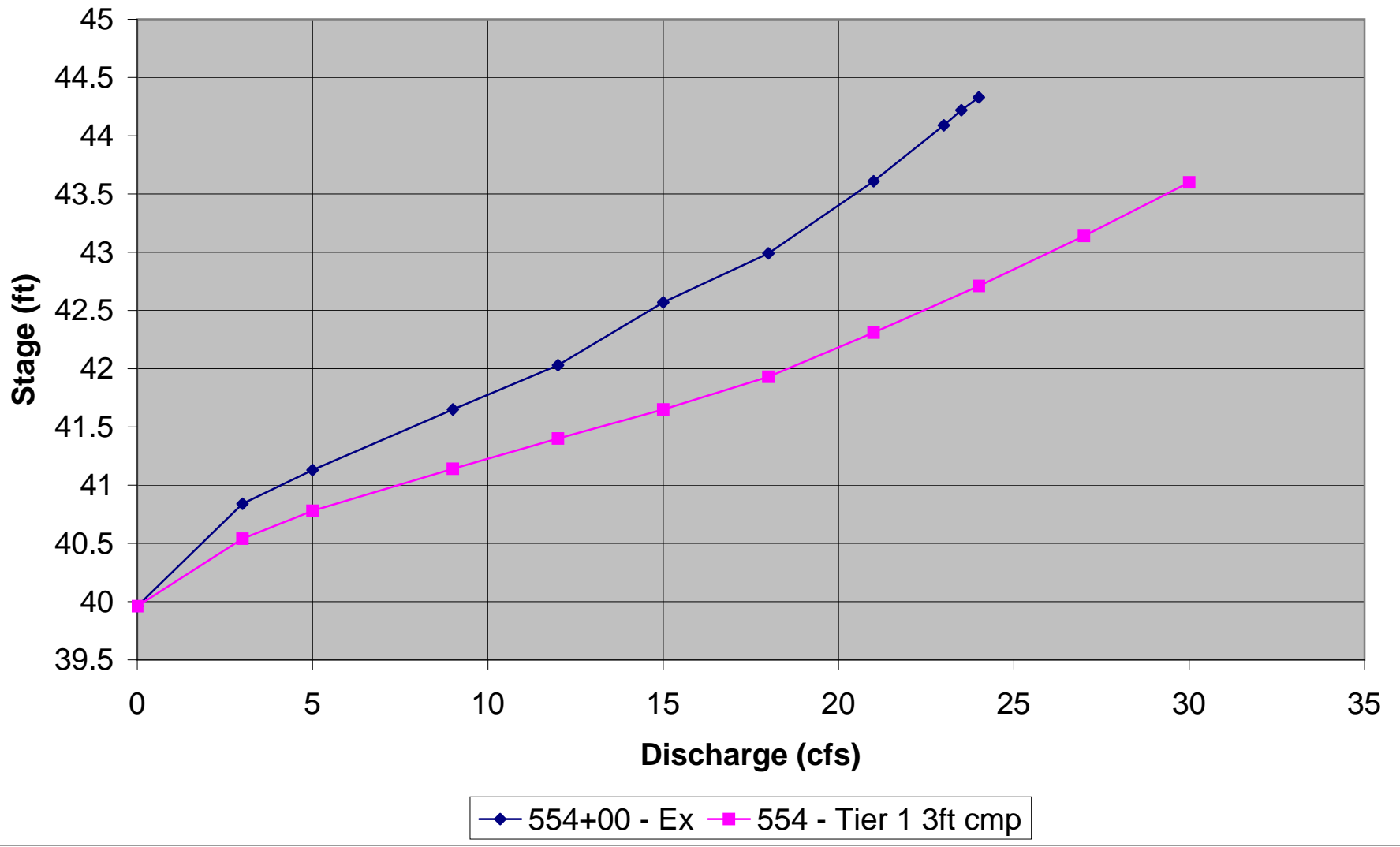

2009 Alignment Station: 530+70

1 2006 S&HI Station 554+00 Existing conditions

CURRENT DATE: 08-25-2006
CURRENT TIME: 16:36:43

FILE DATE: 08-25-2006
FILE NAME: 55400EX

FHWA CULVERT ANALYSIS
HY-8, VERSION 6.1

C SITE DATA CULVERT SHAPE, MATERIAL, INLET
U
L INLET OUTLET CULVERT BARRELS
V ELEV. ELEV. LENGTH SHAPE SPAN RISE MANNING INLET
NO. (ft) (ft) (ft) MATERIAL (ft) (ft) n TYPE
1 39.96 38.91 49.01 1 CSP 2.00 2.00 .024 CONVENTIONAL
2
3
4
5
6

SUMMARY OF CULVERT FLOWS (cfs) FILE: 55400EX DATE: 08-25-2006

ELEV (ft)	TOTAL	1	2	3	4	5	6	ROADWAY ITR
39.96	0	0	0	0	0	0	0	1
40.84	3	3	0	0	0	0	0	1
41.13	5	5	0	0	0	0	0	1
41.65	9	9	0	0	0	0	0	1
42.03	12	12	0	0	0	0	0	1
42.57	15	15	0	0	0	0	0	1
42.99	18	18	0	0	0	0	0	1
43.61	21	21	0	0	0	0	0	1
44.09	24	23	0	0	0	0	0.88	8
44.22	27	23.5	0	0	0	0	3.29	4
44.33	30	24	0	0	0	0	5.95	4
43.99	22.6	22.6	0	0	0	0	0 OVERTOPPING	

SUMMARY OF ITERATIVE SOLUTION ERRORS FILE: 55400EX DATE: 08-25-2006

HEAD ELEV (ft)	HEAD ERROR (ft)	TOTAL FLOW (cfs)	FLOW ERROR (cfs)	% FLOW ERROR
39.96	0.000	0.00	0.00	0.00
40.84	0.000	3.00	0.00	0.00
41.13	0.000	5.00	0.00	0.00
41.65	0.000	9.00	0.00	0.00
42.03	0.000	12.00	0.00	0.00
42.57	0.000	15.00	0.00	0.00
42.99	0.000	18.00	0.00	0.00
43.61	0.000	21.00	0.00	0.00
44.09	-0.010	24.00	0.12	0.50
44.22	-0.005	27.00	0.21	0.78
44.33	-0.008	30.00	0.10	0.33

<1> TOLERANCE (ft) = 0.010

<2> TOLERANCE (%) = 1.000

2

CURRENT DATE: 08-25-2006
CURRENT TIME: 16:36:43

FILE DATE: 08-25-2006
FILE NAME: 55400EX

PERFORMANCE CURVE FOR CULVERT 1 - 1(2.00 (ft) BY 2.00 (ft)) CSP

DIS- FLOW (cfs)	HEAD (ft)	INLET (ft)	OUTLET (ft)	CONTROL	CONTROL	FLOW TYPE	NORMAL DEPTH (ft)	CRIT. DEPTH (ft)	OUTLET DEPTH (ft)	TW DEPTH (ft)	OUTLET VEL. (fps)	TW VEL. (fps)
0.00	39.96	0.00	0.00	0-NF	0.00	0.00	0.00	0.59	0.00	0.00		
3.00	40.84	0.88	0.88	1-S2n	0.55	0.60	0.40	1.04	6.63	1.63		
5.00	41.13	1.17	1.17	1-S2n	0.72	0.79	0.59	1.10	6.51	1.76		
9.00	41.65	1.69	1.69	1-S2n	1.00	1.07	0.87	1.17	6.89	1.94		
12.00	42.03	2.07	2.07	5-S2n	1.20	1.24	1.14	1.22	6.48	2.04		
15.00	42.57	2.51	2.61	2-M2c	1.40	1.40	1.40	1.26	6.41	2.13		
18.00	42.99	3.03	2.90	2-M2c	1.66	1.52	1.52	1.29	7.03	2.21		
21.00	43.61	3.65	3.06	2-M2c	2.00	1.63	1.63	1.32	7.63	2.27		
23.01	44.09	4.13	3.92	2-M2c	2.00	1.69	1.69	1.35	8.14	2.33		
23.50	44.21	4.25	4.23	2-M2c	2.00	1.71	1.71	1.37	8.25	2.39		
23.95	44.33	4.37	4.36	2-M2c	2.00	1.72	1.72	1.40	8.36	2.44		

El. inlet face invert 39.96 ft El. outlet invert 38.91 ft
 El. inlet throat invert 0.00 ft El. inlet crest 0.00 ft

***** SITE DATA ***** CULVERT INVERT *****

INLET STATION 0.00 ft
 INLET ELEVATION 39.96 ft
 OUTLET STATION 49.00 ft
 OUTLET ELEVATION 38.91 ft
 NUMBER OF BARRELS 1
 SLOPE (V/H) 0.0214
 CULVERT LENGTH ALONG SLOPE 49.01 ft

***** CULVERT DATA SUMMARY *****

BARREL SHAPE CIRCULAR
 BARREL DIAMETER 2.00 ft
 BARREL MATERIAL CORRUGATED STEEL
 BARREL MANNING'S n 0.024
 INLET TYPE CONVENTIONAL
 INLET EDGE AND WALL THIN EDGE PROJECTING
 INLET DEPRESSION NONE

3

CURRENT DATE: 08-25-2006
CURRENT TIME: 16:36:43

FILE DATE: 08-25-2006
FILE NAME: 55400EX

TAILWATER

***** USER DEFINED CHANNEL CROSS-SECTION FILE NAME: 55400-TW
MAIN CHANNEL AND LT & RT OVER BANKS FILE DATE: 08-25-2006
LEFT CHANNEL BOUNDARY 2
RIGHT CHANNEL BOUNDARY 5
MANNING n LEFT OVER BANK 0.050
MANNING n MAIN CHANNEL 0.035
MANNING n RIGHT OVER BANK 0.050
SLOPE OF CHANNEL 0.0050 ft/ft

CROSS-SECTION	X	Y
COORD. NO.	(ft)	(ft)
1	0.00	41.00
2	100.00	39.70
3	100.25	39.50
4	101.75	39.50
5	102.00	39.70
6	203.00	41.00

***** UNIFORM FLOW RATING CURVE FOR DOWNSTREAM CHANNEL

FLOW	W.S.E.	FROUDE	DEPTH	VEL.	SHEAR
(cfs)	(ft)	NUMBER	(ft)	(f/s)	(psf)
0.00	39.50	0.000	0.59	0.00	0.00
3.00	39.95	0.439	1.04	1.63	0.13
5.00	40.01	0.447	1.10	1.76	0.14
9.00	40.08	0.459	1.17	1.94	0.16
12.00	40.13	0.465	1.22	2.04	0.17
15.00	40.17	0.469	1.26	2.13	0.19
18.00	40.20	0.474	1.29	2.21	0.20
21.00	40.23	0.477	1.32	2.27	0.20
24.00	40.26	0.480	1.35	2.33	0.21
27.00	40.28	0.483	1.37	2.39	0.22
30.00	40.31	0.486	1.40	2.44	0.23

Note: Shear stress was calculated using R.

ROADWAY OVERTOPPING DATA

ROADWAY SURFACE PAVED
EMBANKMENT TOP WIDTH 24.00 ft
CREST LENGTH 10.00 ft
OVERTOPPING CREST ELEVATION 43.99 ft

2009 Alignment Station: 530+70

1 2006 S&HI Station 554+00 Tier 1 fish passage - 3-ft CMP

CURRENT DATE: 08-29-2006
CURRENT TIME: 20:53:14

FILE DATE: 08-29-2006
FILE NAME: 554-T3

FHWA CULVERT ANALYSIS
HY-8, VERSION 6.1

C	SITE DATA			CULVERT SHAPE, MATERIAL, INLET						
U	L	INLET	OUTLET	CULVERT	BARRELS					
V	ELEV.	ELEV.	LENGTH	SHAPE	SPAN	RISE	MANNING	INLET		
NO.	(ft)	(ft)	(ft)	MATERIAL	(ft)	(ft)	n	TYPE		
1	39.96	38.91	49.01	1 ICMP	3.10	1.80	.024	CONVENTIONAL		
2										
3										
4										
5										
6										

SUMMARY OF CULVERT FLOWS (cfs) FILE: 554-T3 DATE: 08-29-2006

ELEV (ft)	TOTAL	1	2	3	4	5	6	ROADWA`	ITR
39.96	0	0	0	0	0	0	0	0	1
40.54	3	3	0	0	0	0	0	0	1
40.78	5	5	0	0	0	0	0	0	1
41.14	9	9	0	0	0	0	0	0	1
41.4	12	12	0	0	0	0	0	0	1
41.65	15	15	0	0	0	0	0	0	1
41.93	18	18	0	0	0	0	0	0	1
42.31	21	21	0	0	0	0	0	0	1
42.71	24	24	0	0	0	0	0	0	1
43.14	27	27	0	0	0	0	0	0	1
43.6	30	30	0	0	0	0	0	0	1
43.99	32.3	32.3	0	0	0	0	0	0	1

SUMMARY OF ITERATIVE SOLUTION ERRORS FILE: 554-T3 DATE: 08-29-2006

HEAD ELEV (ft)	HEAD ERROR (ft)	TOTAL FLOW (cfs)	FLOW ERROR (cfs)	% FLOW ERROR
39.96	0.000	0.00	0.00	0.00
40.54	0.000	3.00	0.00	0.00
40.78	0.000	5.00	0.00	0.00
41.14	0.000	9.00	0.00	0.00
41.40	0.000	12.00	0.00	0.00
41.65	0.000	15.00	0.00	0.00
41.93	0.000	18.00	0.00	0.00
42.31	0.000	21.00	0.00	0.00
42.71	0.000	24.00	0.00	0.00
43.14	0.000	27.00	0.00	0.00
43.60	0.000	30.00	0.00	0.00

<1> TOLERANCE (ft) = 0.010

<2> TOLERANCE (%) = 1.000

2

CURRENT DATE: 08-29-2006
CURRENT TIME: 20:53:14

FILE DATE: 08-29-2006
FILE NAME: 554-T3

PERFORMANCE CURVE FOR CULVERT 1 - 1(3.10 (ft) BY 1.80 (ft)) ICMP

DIS- FLOW (cfs)	HEAD (ft)	INLET (ft)	OUTLET (ft)	CONTROL	CONTROL	FLOW TYPE	NORMAL DEPTH (ft)	CRIT. DEPTH (ft)	OUTLET DEPTH (ft)	TW DEPTH (ft)	OUTLET VEL. (fps)	TW VEL. (fps)
0.00	39.96	0.00	0.00	0-NF	0.00	0.00	0.00	0.59	0.00	0.00	0.00	0.00
3.00	40.54	0.58	0.58	1-S2n	0.28	0.31	0.21	1.05	5.79	1.51		
5.00	40.78	0.82	0.82	1-S2n	0.39	0.44	0.34	1.10	4.95	1.63		
9.00	41.14	1.18	1.18	1-S2n	0.58	0.64	0.44	1.17	6.77	1.79		
12.00	41.40	1.44	1.44	1-S2n	0.72	0.78	0.72	1.22	5.63	1.89		
15.00	41.65	1.69	1.69	1-S2n	0.86	0.90	0.80	1.26	6.35	1.97		
18.00	41.93	1.97	1.97	5-S2n	1.00	1.02	0.92	1.29	6.73	2.04		
21.00	42.31	2.35	2.27	3-M1t	1.15	1.13	1.32	1.32	5.78	2.10		
24.00	42.71	2.75	2.47	3-M1t	1.32	1.23	1.35	1.35	6.50	2.15		
27.00	43.14	3.18	2.72	3-M2t	1.60	1.31	1.38	1.38	7.21	2.20		
30.00	43.60	3.64	2.92	3-M2t	1.80	1.39	1.40	1.40	7.91	2.25		

El. inlet face invert 39.96 ft El. outlet invert 38.91 ft
 El. inlet throat invert 0.00 ft El. inlet crest 0.00 ft

***** SITE DATA ***** CULVERT INVERT *****

INLET STATION 0.00 ft
 INLET ELEVATION 39.96 ft
 OUTLET STATION 49.00 ft
 OUTLET ELEVATION 38.91 ft
 NUMBER OF BARRELS 1
 SLOPE (V/H) 0.0214
 CULVERT LENGTH ALONG SLOPE 49.01 ft

***** CULVERT DATA SUMMARY *****

BARREL SHAPE USER DEFINED
 BARREL SPAN 3.10 ft
 BARREL RISE 1.80 ft
 BARREL MATERIAL STEEL OR ALUMINUM
 BARREL MANNING'S n 0.024 FOR SIDES AND TOP
 0.038 FOR BOTTOM
 INLET TYPE CONVENTIONAL
 INLET EDGE AND WALL MITERED
 INLET DEPRESSION NONE

3

CURRENT DATE: 08-29-2006

FILE DATE: 08-29-2006

CURRENT TIME: 20:53:14

FILE NAME: 554-T3

***** USER DEFINED CULVERT CROSS-SECTION - CULVERT # 1

COORDIN X NUMBER (ft)	Y-TOP (ft)	Y-BOTTOM (ft)	Y-BOTTOM (ft)
1	73.3	40.26	40.26
2	73.4	40.56	39.96
3	73.7	41.19	39.96
4	74	41.47	39.96
5	74.3	41.64	39.96
6	74.6	41.73	39.96
7	74.8	41.76	39.96
8	75.1	41.73	39.96
9	75.4	41.64	39.96
10	75.7	41.47	39.96
11	76	41.19	39.96
12	76.3	40.56	39.96
13	76.4	40.26	40.26

4

CURRENT DATE: 08-29-2006
CURRENT TIME: 20:53:14

FILE DATE: 08-29-2006
FILE NAME: 554-T3

TAILWATER

***** USER DEFINED CHANNEL CROSS-SECTION

FILE NAME: 554-T3
FILE DATE: 08-29-2006

MAIN CHANNEL AND LT & RT OVER BANKS
 LEFT CHANNEL BOUNDARY 2
 RIGHT CHANNEL BOUNDARY 5
 MANNING n LEFT OVER BANK 0.050
 MANNING n MAIN CHANNEL 0.038
 MANNING n RIGHT OVER BANK 0.050
 SLOPE OF CHANNEL 0.0050 ft/ft

CROSS-SECTION COORD. NO.	X (ft)	Y (ft)
1	0.00	41.00
2	100.00	39.70
3	100.25	39.50
4	101.75	39.50
5	102.00	39.70
6	203.00	41.00

***** UNIFORM FLOW RATING CURVE FOR DOWNSTREAM CHANNEL

FLOW (cfs)	W.S.E. (ft)	FROUDE NUMBER	DEPTH (ft)	VEL. (f/s)	SHEAR (psf)
0.00	39.50	0.000	0.59	0.00	0.00
3.00	39.96	0.405	1.05	1.51	0.13
5.00	40.01	0.413	1.10	1.63	0.14

9.00	40.08	0.423	1.17	1.79	0.16
12.00	40.13	0.428	1.22	1.89	0.18
15.00	40.17	0.433	1.26	1.97	0.19
18.00	40.20	0.436	1.29	2.04	0.20
21.00	40.23	0.440	1.32	2.10	0.21
24.00	40.26	0.443	1.35	2.15	0.21
27.00	40.29	0.445	1.38	2.20	0.22
30.00	40.31	0.447	1.40	2.25	0.23

Note: Shear stress was calculated using R.

ROADWAY OVERTOPPING DATA

ROADWAY SURFACE	PAVED
EMBANKMENT TOP WIDTH	24.00 ft
CREST LENGTH	10.00 ft
OVERTOPPING CREST ELEVATION	43.99 ft

2009 Alignment Station: 606+68

1 2006 S&HI Station 630+00 Existing conditions

CURRENT DATE: 08-25-2006
CURRENT TIME: 16:39:00

FILE DATE: 08-25-2006
FILE NAME: 63000

FHWA CULVERT ANALYSIS
HY-8, VERSION 6.1

C SITE DATA CULVERT SHAPE, MATERIAL, INLET
U
L INLET OUTLET CULVERT BARRELS
V ELEV. ELEV. LENGTH SHAPE SPAN RISE MANNING INLET
NO. (ft) (ft) (ft) MATERIAL (ft) (ft) n TYPE
1 45.81 45.36 59.00 1 CSP 2.00 2.00 .024 CONVENTIONAL
2
3
4
5
6

SUMMARY OF CULVERT FLOWS (cfs) FILE: 63000 DATE: 08-25-2006

ELEV (ft)	TOTAL	1	2	3	4	5	6 ROADWAY	ITR
45.81	0	0	0	0	0	0	0	1
46.78	3	3	0	0	0	0	0	1
47.1	5	5	0	0	0	0	0	1
47.63	9	9	0	0	0	0	0	1
48.03	12	12	0	0	0	0	0	1
48.34	15	15	0	0	0	0	0	1
49.31	18	18	0	0	0	0	0	1
50.23	21	21	0	0	0	0	0	1
51.11	24	23.6	0	0	0	0	0.33	6
51.27	27	24	0	0	0	0	2.84	5
51.38	30	24.4	0	0	0	0	5.49	4
51.06	23.4	23.4	0	0	0	0	0 OVERTOPP	ING

SUMMARY OF ITERATIVE SOLUTION ERRORS FILE: 63000 DATE: 08-25-2006

HEAD ELEV (ft)	HEAD ERROR (ft)	TOTAL FLOW (cfs)	FLOW ERROR (cfs)	% FLOW ERROR
45.81	0.000	0.00	0.00	0.00
46.78	0.000	3.00	0.00	0.00
47.10	0.000	5.00	0.00	0.00
47.63	0.000	9.00	0.00	0.00
48.03	0.000	12.00	0.00	0.00
48.34	0.000	15.00	0.00	0.00
49.31	0.000	18.00	0.00	0.00
50.23	0.000	21.00	0.00	0.00
51.11	-0.005	24.00	0.08	0.33
51.27	-0.008	27.00	0.12	0.44
51.38	-0.009	30.00	0.12	0.40

<1> TOLERANCE (ft) = 0.010

<2> TOLERANCE (%) = 1.000

2

CURRENT DATE: 08-25-2006
CURRENT TIME: 16:39:00

FILE DATE: 08-25-2006
FILE NAME: 63000

PERFORMANCE CURVE FOR CULVERT 1 - 1(2.00 (ft) BY 2.00 (ft)) CSP

DIS- FLOW (cfs)	HEAD (ft)	INLET (ft)	OUTLET (ft)	CONTROL	CONTROL	FLOW TYPE	NORMAL DEPTH (ft)	CRIT. DEPTH (ft)	OUTLET TW (fps)	OUTLET TW (fps)
0.00	45.81	0.00	0.00	0-NF	0.00	0.00	0.00	0.14	0.00	0.00
3.00	46.78	0.89	0.97	2-M2c	0.72	0.60	0.60	0.14	3.75	0.00
5.00	47.10	1.18	1.29	2-M2c	0.96	0.79	0.79	0.14	4.36	0.00
9.00	47.63	1.70	1.82	2-M2c	1.41	1.07	1.07	0.14	5.28	0.00
12.00	48.03	2.09	2.22	2-M2c	2.00	1.24	1.24	0.14	5.85	0.00
15.00	48.34	2.53	2.41	2-M2c	2.00	1.40	1.40	0.14	6.41	0.00
18.00	49.31	3.04	3.50	2-M2c	2.00	1.52	1.52	0.14	7.03	0.00
21.00	50.23	3.66	4.42	2-M2c	2.00	1.63	1.63	0.14	7.63	0.00
23.59	51.12	4.29	5.31	2-M2c	2.00	1.71	1.71	0.14	8.27	0.00
24.05	51.27	4.41	5.46	2-M2c	2.00	1.72	1.72	0.14	8.38	0.00
24.39	51.38	4.50	5.57	2-M2c	2.00	1.73	1.73	0.14	8.46	0.00

El. inlet face invert 45.81 ft El. outlet invert 45.36 ft
 El. inlet throat invert 0.00 ft El. inlet crest 0.00 ft

***** SITE DATA ***** CULVERT INVERT *****

INLET STATION 0.00 ft
 INLET ELEVATION 45.81 ft
 OUTLET STATION 59.00 ft
 OUTLET ELEVATION 45.36 ft
 NUMBER OF BARRELS 1
 SLOPE (V/H) 0.0076
 CULVERT LENGTH ALONG SLOPE 59.00 ft

***** CULVERT DATA SUMMARY *****

BARREL SHAPE CIRCULAR
 BARREL DIAMETER 2.00 ft
 BARREL MATERIAL CORRUGATED STEEL
 BARREL MANNING'S n 0.024
 INLET TYPE CONVENTIONAL
 INLET EDGE AND WALL THIN EDGE PROJECTING
 INLET DEPRESSION NONE

3

CURRENT DATE: 08-25-2006
CURRENT TIME: 16:39:00

FILE DATE: 08-25-2006
FILE NAME: 63000

TAILWATER

CONSTANT WATER SURFACE ELEVATION
45.5

ROADWAY OVERTOPPING DATA

ROADWAY SURFACE	PAVED
EMBANKMENT TOP WIDTH	24.00 ft
CREST LENGTH	10.00 ft
OVERTOPPING CREST ELEVATION	51.06 ft

2009 Alignment Station: 606+68
 2006 S&H Station 630+00 Tier 2 FISH PASS design

baffle design: 3-ft pipe / Juvenile Cutthroat
 Juvenile Cutthroat trout assumed equal to Dolly Varden - equivalent length to input to Fish Pass is 85mm

Weir Baffle					
Weak Swimming Fish Length (mm)	Slope (%)	Manning n	Q Fish (cfs)	Q Flood (cfs)	Conduit Diameter (ft)
85	8	0.024	3	17	3

Calculated Parameters					
Weir Height = 1 = 0 .15 = 0					
Water Velocity in small fish passage zone (ft/sec)	2.05	1.52			
Fish power required at weir (watts)	0.04	0.03			
Fish power capabilities (watts)	0.18	0.18			
Depth of flow over weir (ft)	0.78	0.56			
Depth of flow at outlet (ft)	1.08	1.01			
Normal Depth at flood Flow (ft)	2.16	2.39			

Acceptable Design

3-ft pipe / Adult Cutthroat
 Adult Cutthroat trout assumed equal to Arctic Grayling - equivalent length to input to Fish Pass is 240 mm

Weir Baffle					
Weak Swimming Fish Length (mm)	Slope (%)	Manning n	Q Fish (cfs)	Q Flood (cfs)	Conduit Diameter (ft)
240	8	0.024	3	17	3

Calculated Parameters					
Weir Height = 1 = 0 .15 = 0					
Water Velocity in small fish passage zone (ft/sec)	2.05	1.52			
Fish power required at weir (watts)	0.30	0.18			
Fish power capabilities (watts)	4.00	4.00			
Depth of flow over weir (ft)	0.78	0.56			
Depth of flow at outlet (ft)	1.08	1.01			
Normal Depth at flood Flow (ft)	2.16	2.39			

Acceptable Design

non-baffle design: 3-ft pipe / Juvenile Coho
 Need to maintain 0.6-ft of TW

Weir Baffle									
Fish Length (mm)	Conduit Length (ft)	Slope (%)	Manning n	Q Fish (cfs)	Q Flood (cfs)	Conduit Diameter (ft)	Bed Depth (ft)	Outlet Depth (ft)	Inlet Depth (ft)
85	59	8	0.024	3	3	3	0	0	6

Calculated Fish Parameters				
Allowable Vel. (ft/sec)	Min. Flow Depth (ft)	Possible Power (watts)	Outlet (ft)	Inlet (ft)
4.4	0.46	0.31	0.53	0.53

Calculated Flow Parameters		
Depth (ft)	Normal Flow (ft/sec)	Critical Flow (ft/sec)
0.62	0.54	3.47

Acceptable Design

2-ft pipe / Juvenile Coho

Weir Baffle									
Fish Length (mm)	Conduit Length (ft)	Slope (%)	Manning n	Q Fish (cfs)	Q Flood (cfs)	Conduit Diameter (ft)	Bed Depth (ft)	Outlet Depth (ft)	Inlet Depth (ft)
85	59	8	0.024	3	3	2	0	0	6

Calculated Fish Parameters				
Allowable Vel. (ft/sec)	Min. Flow Depth (ft)	Possible Power (watts)	Outlet (ft)	Inlet (ft)
4.4	0.54	0.31	0.53	0.53

Calculated Flow Parameters		
Depth (ft)	Normal Flow (ft/sec)	Critical Flow (ft/sec)
0.72	0.60	3.75

Acceptable Design

2-ft pipe / Adult Cutthroat
 Adult Cutthroat trout assumed equal to Arctic Grayling - equivalent length to input to Fish Pass is 240 mm

Weir Baffle									
Fish Length (mm)	Conduit Length (ft)	Slope (%)	Manning n	Q Fish (cfs)	Q Flood (cfs)	Conduit Diameter (ft)	Bed Depth (ft)	Outlet Depth (ft)	Inlet Depth (ft)
240	59	8	0.024	3	3	2	0	0	6

Calculated Fish Parameters				
Allowable Vel. (ft/sec)	Min. Flow Depth (ft)	Possible Power (watts)	Outlet (ft)	Inlet (ft)
5.3	0.47	4.00	12.00	12.00

Calculated Flow Parameters		
Depth (ft)	Normal Flow (ft/sec)	Critical Flow (ft/sec)
0.72	0.60	3.75

Acceptable Design

2-ft pipe / Adult Coho

Weir Baffle									
Fish Length (mm)	Conduit Length (ft)	Slope (%)	Manning n	Q Fish (cfs)	Q Flood (cfs)	Conduit Diameter (ft)	Bed Depth (ft)	Outlet Depth (ft)	Inlet Depth (ft)
240	59	8	0.024	3	3	2	0	0	6

Calculated Fish Parameters				
Allowable Vel. (ft/sec)	Min. Flow Depth (ft)	Possible Power (watts)	Outlet (ft)	Inlet (ft)
6.3	0.42	38.11	187.50	187.50

Calculated Flow Parameters		
Depth (ft)	Normal Flow (ft/sec)	Critical Flow (ft/sec)
0.72	0.60	3.75

Acceptable Design

Adult Coho
 Note: L * 1.57 converts swimming ability to 'equivalent grayling'
 Assume depth based on actual body size of 600-mm fish shown to adjacent

Weir Baffle									
Fish Length (mm)	Conduit Length (ft)	Slope (%)	Manning n	Q Fish (cfs)	Q Flood (cfs)	Conduit Diameter (ft)	Bed Depth (ft)	Outlet Depth (ft)	Inlet Depth (ft)
942	59	8	0.024	3	3	2	0	0	6

Calculated Fish Parameters				
Allowable Vel. (ft/sec)	Min. Flow Depth (ft)	Possible Power (watts)	Outlet (ft)	Inlet (ft)
6.7	0.40	115.59	725.60	725.60

Calculated Flow Parameters		
Depth (ft)	Normal Flow (ft/sec)	Critical Flow (ft/sec)
0.72	0.60	3.75

Normal Depth too shallow

736+83

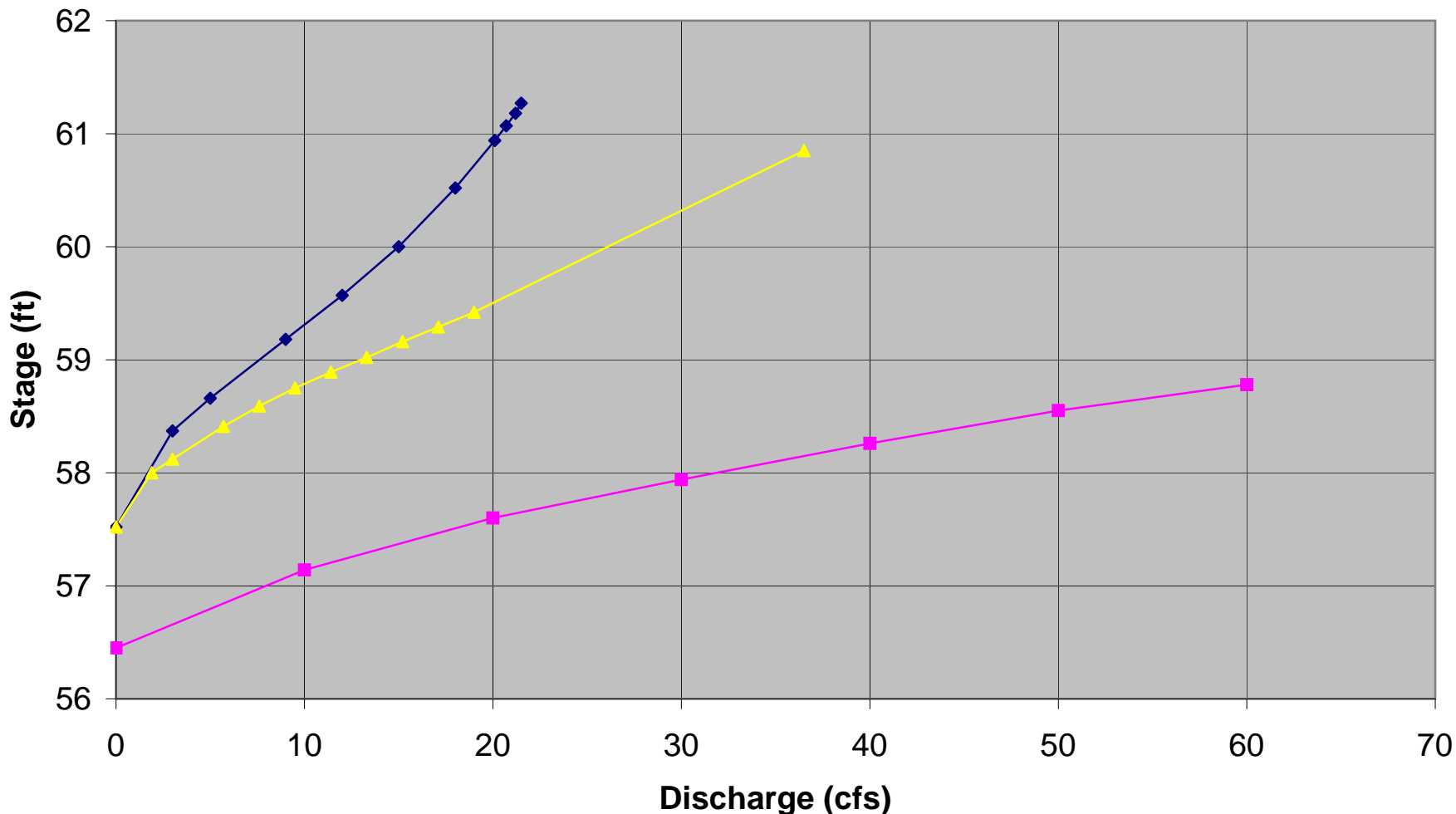

◆ 757+50 - Ex ■ 757+50 Tier 1 pipe arch ▲ 757+50 Tier 2 3ft CMP w. baffles

2009 Alignment Station: 736+83

1 2006 S&HI Station 757+50 Existing conditions

CURRENT DATE: 08-25-2006
CURRENT TIME: 16:42:47

FILE DATE: 08-25-2006
FILE NAME: 75750EX

FHWA CULVERT ANALYSIS
HY-8, VERSION 6.1

C SITE DATA CULVERT SHAPE, MATERIAL, INLET
U
L INLET OUTLET CULVERT BARRELS
V ELEV. ELEV. LENGTH SHAPE SPAN RISE MANNING INLET
NO. (ft) (ft) (ft) MATERIAL (ft) (ft) n TYPE
1 57.52 54.50 60.48 1 CSP 2.00 2.00 .024 CONVENTIONAL
2
3
4
5
6

SUMMARY OF CULVERT FLOWS (cfs) FILE: 75750EX DATE: 08-25-2006

ELEV (ft)	TOTAL	1	2	3	4	5	6 ROADWAY	ITR
57.52	0	0	0	0	0	0	0	1
58.37	3	3	0	0	0	0	0	1
58.66	5	5	0	0	0	0	0	1
59.18	9	9	0	0	0	0	0	1
59.57	12	12	0	0	0	0	0	1
60	15	15	0	0	0	0	0	1
60.52	18	18	0	0	0	0	0	1
60.94	21	20.1	0	0	0	0	0.8	8
61.07	24	20.7	0	0	0	0	3.12	4
61.18	27	21.2	0	0	0	0	5.72	4
61.27	30	21.5	0	0	0	0	8.21	3
60.85	19.6	19.6	0	0	0	0	0 OVERTOPP	ING

SUMMARY OF ITERATIVE SOLUTION ERRORS FILE: 75750EX DATE: 08-25-2006

HEAD ELEV (ft)	HEAD ERROR (ft)	TOTAL FLOW (cfs)	FLOW ERROR (cfs)	% FLOW ERROR
57.52	0.000	0.00	0.00	0.00
58.37	0.000	3.00	0.00	0.00
58.66	0.000	5.00	0.00	0.00
59.18	0.000	9.00	0.00	0.00
59.57	0.000	12.00	0.00	0.00
60.00	0.000	15.00	0.00	0.00
60.52	0.000	18.00	0.00	0.00
60.94	-0.008	21.00	0.12	0.57
61.07	-0.005	24.00	0.21	0.88
61.18	-0.009	27.00	0.12	0.44
61.27	-0.006	30.00	0.26	0.87

<1> TOLERANCE (ft) = 0.010

<2> TOLERANCE (%) = 1.000

2

CURRENT DATE: 08-25-2006
CURRENT TIME: 16:42:47

FILE DATE: 08-25-2006
FILE NAME: 75750EX

PERFORMANCE CURVE FOR CULVERT 1 - 1(2.00 (ft) BY 2.00 (ft)) CSP

DIS- FLOW (cfs)	HEAD (ft)	INLET (ft)	OUTLET (ft)	CONTROL	CONTROL	FLOW (ft)	NORMAL (ft)	CRIT. (ft)	OUTLET TW (ft)	OUTLET TW (ft)
			<F4>	DEPTH (ft)	DEPTH (ft)	DEPTH (ft)	DEPTH (ft)	DEPTH (ft)	DEPTH (ft)	VEL. (fps)

0.00	57.52	0.00	0.00	0-NF	0.00	0.00	0.00	-0.74	0.00	0.00
3.00	58.37	0.85	0.85	1-S2n	0.44	0.60	0.30	-0.41	9.65	2.21
5.00	58.66	1.14	1.14	1-S2n	0.57	0.79	0.49	-0.34	8.39	2.58
9.00	59.18	1.66	1.66	1-S2n	0.79	1.07	0.67	-0.22	9.78	3.11
12.00	59.57	2.05	2.05	5-S2n	0.92	1.24	0.84	-0.15	9.58	3.42
15.00	60.00	2.48	2.48	5-S2n	1.05	1.40	1.00	-0.08	9.60	3.68
18.00	60.52	3.00	3.00	5-S2n	1.18	1.52	1.12	-0.01	9.92	3.92
20.09	60.94	3.42	3.42	5-S2n	1.27	1.61	1.21	0.05	10.13	4.12
20.67	61.07	3.55	3.55	5-S2n	1.30	1.62	1.22	0.11	10.25	4.30
21.17	61.18	3.66	3.66	5-S2n	1.32	1.64	1.24	0.16	10.35	4.48
21.53	61.26	3.74	3.74	5-S2n	1.34	1.65	1.25	0.22	10.42	4.63

El. inlet face invert 57.52 ft El. outlet invert 54.50 ft
 El. inlet throat invert 0.00 ft El. inlet crest 0.00 ft

***** SITE DATA ***** CULVERT INVERT *****

INLET STATION 0.00 ft
 INLET ELEVATION 57.52 ft
 OUTLET STATION 60.40 ft
 OUTLET ELEVATION 54.50 ft
 NUMBER OF BARRELS 1
 SLOPE (V/H) 0.0500
 CULVERT LENGTH ALONG SLOPE 60.48 ft

***** CULVERT DATA SUMMARY *****

BARREL SHAPE CIRCULAR
 BARREL DIAMETER 2.00 ft
 BARREL MATERIAL CORRUGATED STEEL
 BARREL MANNING'S n 0.024
 INLET TYPE CONVENTIONAL
 INLET EDGE AND WALL THIN EDGE PROJECTING
 INLET DEPRESSION NONE

3

CURRENT DATE: 08-25-2006
CURRENT TIME: 16:42:47

FILE DATE: 08-25-2006
FILE NAME: 75750EX

TAILWATER

***** USER DEFINED CHANNEL CROSS-SECTION FILE NAME: 75750TW
MAIN CHANNEL ONLY FILE DATE: 08-25-2006
LEFT CHANNEL BOUNDARY 0
RIGHT CHANNEL BOUNDARY 0
MANNING n LEFT OVER BANK 0.000
MANNING n MAIN CHANNEL 0.035
MANNING n RIGHT OVER BANK 0.000
SLOPE OF CHANNEL 0.0180 ft/ft

CROSS-SECTION X Y
COORD. NO. (ft) (ft)
1 0.00 57.61
2 3.40 53.76
3 6.50 53.82
4 10.20 53.91
5 12.80 57.07

***** UNIFORM FLOW RATING CURVE FOR DOWNSTREAM CHANNEL

FLOW (cfs)	W.S.E. (ft)	FROUDE NUMBER	DEPTH (ft)	VEL. (f/s)	SHEAR (psf)
0.00	53.76	0.000	-0.74	0.00	0.00
3.00	54.09	0.780	-0.41	2.21	0.27
5.00	54.16	0.807	-0.34	2.58	0.34
9.00	54.28	0.840	-0.22	3.11	0.45
12.00	54.35	0.857	-0.15	3.42	0.52
15.00	54.42	0.870	-0.08	3.68	0.58
18.00	54.49	0.881	-0.01	3.92	0.64
21.00	54.55	0.890	0.05	4.12	0.69
24.00	54.61	0.897	0.11	4.30	0.74
27.00	54.66	0.904	0.16	4.48	0.78
30.00	54.72	0.910	0.22	4.63	0.82

Note: Shear stress was calculated using R.

ROADWAY OVERTOPPING DATA

ROADWAY SURFACE	PAVED
EMBANKMENT TOP WIDTH	24.00 ft
CREST LENGTH	10.00 ft
OVERTOPPING CREST ELEVATION	60.85 ft

2009 Alignment Station: 736+83

1 2006 S&HI Station 757+50 Tier 1 fish passage - Pipe arch

CURRENT DATE: 09-07-2006
 CURRENT TIME: 18:39:05

FILE DATE: 09-07-2006
 FILE NAME: 757T1AR

FHWA CULVERT ANALYSIS
 HY-8, VERSION 6.1

C	SITE DATA			CULVERT SHAPE, MATERIAL, INLET					
U									
L	INLET	OUTLET	CULVERT	BARRELS					
V	ELEV.	ELEV.	LENGTH	SHAPE	SPAN	RISE	MANNING	INLET	
NO.	(ft)	(ft)	(ft)	MATERIAL	(ft)	(ft)	n	TYPE	
1	56.45	53.43	60.48	1 ICMP	7.26	4.18	.028	CONVENTIONAL	
2									
3									
4									
5									
6									

SUMMARY OF CULVERT FLOWS (cfs) FILE: 757T1AR DATE: 09-07-2006

ELEV (ft)	TOTAL	1	2	3	4	5	6	ROADWAY	ITR
56.45	0	0	0	0	0	0	0	0	1
57.14	10	10	0	0	0	0	0	0	1
57.6	20	20	0	0	0	0	0	0	1
57.94	30	30	0	0	0	0	0	0	1
58.26	40	40	0	0	0	0	0	0	1
58.55	50	50	0	0	0	0	0	0	1
58.78	60	60	0	0	0	0	0	0	1
59.02	70	70	0	0	0	0	0	0	1
59.25	80	80	0	0	0	0	0	0	1
59.49	90	90	0	0	0	0	0	0	1
59.72	100	100	0	0	0	0	0	0	1
60.85	149.4	149.4	0	0	0	0	0	0 OVERTOPP	ING

SUMMARY OF ITERATIVE SOLUTION ERRORS FILE: 757T1AR DATE: 09-07-2006

HEAD	HEAD	TOTAL	FLOW	% FLOW
ELEV (ft)	ERROR (ft)	FLOW (cfs)	ERROR (cfs)	ERROR
56.45	0.000	0.00	0.00	0.00
57.14	0.000	10.00	0.00	0.00
57.60	0.000	20.00	0.00	0.00
57.94	0.000	30.00	0.00	0.00
58.26	0.000	40.00	0.00	0.00
58.55	0.000	50.00	0.00	0.00

58.78	0.000	60.00	0.00	0.00
59.02	0.000	70.00	0.00	0.00
59.25	0.000	80.00	0.00	0.00
59.49	0.000	90.00	0.00	0.00
59.72	0.000	100.00	0.00	0.00

<1> TOLERANCE (ft) = 0.010

<2> TOLERANCE (%) = 1.000

2

CURRENT DATE: 09-07-2006
CURRENT TIME: 18:39:05

FILE DATE: 09-07-2006
FILE NAME: 757T1AR

PERFORMANCE CURVE FOR CULVERT 1 - 1(7.26 (ft) BY 4.18 (ft)) ICMP

DIS- HEAD- INLET OUTLET

CHARGE WATER CONTROL CONTROL FLOW NORMAL CRIT. OUTLET TW OUTLET TW
FLOW ELEV. DEPTH DEPTH TYPE DEPTH DEPTH DEPTH DEPTH VEL. VEL.
(cfs) (ft) (ft) (ft) <F4> (ft) (ft) (ft) (ft) (fps) (fps)

0.00	56.45	0.00	0.00	0-NF	0.00	0.00	0.00	0.33	0.00	0.00
10.00	57.14	0.69	0.69	1-S2n	0.23	0.39	0.09	0.88	8.78	3.22
20.00	57.60	1.15	1.15	1-S2n	0.44	0.61	0.31	1.10	7.27	4.05
30.00	57.94	1.49	1.49	1-S2n	0.55	0.82	0.56	1.29	7.54	4.63
40.00	58.26	1.81	1.81	1-S2n	0.66	0.98	0.58	1.45	9.67	5.09
50.00	58.55	2.10	2.10	1-S2n	0.78	1.14	0.79	1.59	8.93	5.47
60.00	58.78	2.33	2.33	1-S2n	0.88	1.29	0.79	1.73	10.63	5.79
70.00	59.02	2.57	2.57	1-S2n	0.97	1.43	0.93	1.85	10.60	6.07
80.00	59.25	2.80	2.80	1-S2n	1.06	1.56	0.96	1.97	11.68	6.33
90.00	59.49	3.04	3.04	1-S2n	1.15	1.69	1.09	2.09	11.57	6.56
100.00	59.72	3.27	3.27	1-S2n	1.24	1.81	1.25	2.19	11.28	6.78

El. inlet face invert 56.45 ft El. outlet invert 53.43 ft
El. inlet throat invert 0.00 ft El. inlet crest 0.00 ft

***** SITE DATA ***** CULVERT INVERT *****

INLET STATION 0.00 ft
INLET ELEVATION 56.45 ft
OUTLET STATION 60.40 ft
OUTLET ELEVATION 53.43 ft
NUMBER OF BARRELS 1
SLOPE (V/H) 0.0500
CULVERT LENGTH ALONG SLOPE 60.48 ft

***** CULVERT DATA SUMMARY *****

BARREL SHAPE USER DEFINED
BARREL SPAN 7.26 ft
BARREL RISE 4.18 ft
BARREL MATERIAL STEEL OR ALUMINUM
BARREL MANNING'S n 0.028 FOR SIDES AND TOP

0.038 FOR BOTTOM
INLET TYPE CONVENTIONAL
INLET EDGE AND WALL MITERED
INLET DEPRESSION NONE

3

CURRENT DATE: 09-07-2006
CURRENT TIME: 18:39:05

FILE DATE: 09-07-2006
FILE NAME: 757T1AR

***** USER DEFINED CULVERT CROSS-SECTION - CULVERT # 1

COORDINATE NUMBER	X (ft)	Y-TOP (ft)	Y-BOTTOM (ft)
1	0.00	58.26	58.26
2	0.17	59.16	57.52
3	0.86	60.42	57.52
4	1.55	61.05	57.52
5	2.24	61.43	57.52
6	2.94	61.63	57.52
7	3.63	61.70	57.52
8	4.32	61.63	57.52
9	5.01	61.43	57.52
10	5.71	61.05	57.52
11	6.40	60.42	57.52
12	7.09	59.16	57.52
13	7.26	58.18	58.18

4

CURRENT DATE: 09-07-2006
CURRENT TIME: 18:39:05

FILE DATE: 09-07-2006
FILE NAME: 757T1AR

TAILWATER

***** USER DEFINED CHANNEL CROSS-SECTION FILE NAME: 75750TW

MAIN CHANNEL ONLY FILE DATE: 08-25-2006
LEFT CHANNEL BOUNDARY 0
RIGHT CHANNEL BOUNDARY 0
MANNING n LEFT OVER BANK 0.000
MANNING n MAIN CHANNEL 0.035
MANNING n RIGHT OVER BANK 0.000
SLOPE OF CHANNEL 0.0180 ft/ft

CROSS-SECTION X Y

COORD. NO.	(ft)	(ft)
1	0.00	57.61
2	3.40	53.76
3	6.50	53.82
4	10.20	53.91
5	12.80	57.07

***** UNIFORM FLOW RATING CURVE FOR DOWNSTREAM CHANNEL

FLOW (cfs)	W.S.E. (ft)	FROUDE NUMBER	DEPTH (ft)	VEL. (f/s)	SHEAR (psf)
0.00	53.76	0.000	0.33	0.00	0.00
10.00	54.31	0.847	0.88	3.22	0.48
20.00	54.53	0.887	1.10	4.05	0.67
30.00	54.72	0.910	1.29	4.63	0.82
40.00	54.88	0.925	1.45	5.09	0.95
50.00	55.02	0.937	1.59	5.47	1.06
60.00	55.16	0.946	1.73	5.79	1.15
70.00	55.28	0.954	1.85	6.07	1.24
80.00	55.40	0.960	1.97	6.33	1.32
90.00	55.52	0.965	2.09	6.56	1.39
100.00	55.62	0.970	2.19	6.78	1.46

Note: Shear stress was calculated using R.

ROADWAY OVERTOPPING DATA

ROADWAY SURFACE	PAVED
EMBANKMENT TOP WIDTH	24.00 ft
CREST LENGTH	10.00 ft
OVERTOPPING CREST ELEVATION	60.85 ft

2009 Alignment Station: 736+83
 2006 S&H Station 757+50 Tier 2 FISH PASS design

non baffled design: 3-ft pipe at slope of existing pipe
 Juvenile Coho

Weak Swimming Fish Passage

Fish Length (mm)	Culvert (ft)	Slope (%)	Manning n	Q (cfs)	Culvert Diam. (ft)	Bed (ft)	Outlet (ft)	Depth (ft)
96	60	5	0.028	0.038	3	3	1	1.8

--- Fish Passage ---

Allowable Vel. (ft/sec)	Min. Flow Depth (ft)	Possible Power (watts)	Possible Energy (joules)	Outlet (ft)	Inlet (ft)
4.3	0.24	0.42	0.77		

Calculated Flow Parameters

Depth (ft)	Normal Flow (ft/sec)	Critical Flow (ft/sec)
0.29	3.58	3.19

Fish power required in outlet zone (watts)
 Fish energy required in outlet zone (joules)
 Fish power required at inlet (watts)
 Fish energy required at inlet (joules)

Normal Flow Supercritical | Supercritical flow in culvert

Adult Coho

Weak Swimming Fish Passage

Fish Length (mm)	Culvert (ft)	Slope (%)	Manning n	Q (cfs)	Culvert Diam. (ft)	Bed (ft)	Outlet (ft)	Depth (ft)
600	60	5	0.028	0.038	3	3	1	1.8

--- Fish Passage ---

Allowable Vel. (ft/sec)	Min. Flow Depth (ft)	Possible Power (watts)	Possible Energy (joules)	Outlet (ft)	Inlet (ft)
4.9	0.21	38.11	187.50		

Calculated Flow Parameters

Depth (ft)	Normal Flow (ft/sec)	Critical Flow (ft/sec)
0.29	3.58	3.19

Fish power required in outlet zone (watts)
 Fish energy required in outlet zone (joules)
 Fish power required at inlet (watts)
 Fish energy required at inlet (joules)

Normal Flow Supercritical | Supercritical flow in culvert

Adult coho - adjusted to 'equivalent' grayling

Weak Swimming Fish Passage

Fish Length (mm)	Culvert (ft)	Slope (%)	Manning n	Q (cfs)	Culvert Diam. (ft)	Bed (ft)	Outlet (ft)	Depth (ft)
942	60	5	0.028	0.038	3	3	1	1.8

--- Fish Passage ---

Allowable Vel. (ft/sec)	Min. Flow Depth (ft)	Possible Power (watts)	Possible Energy (joules)	Outlet (ft)	Inlet (ft)
4.6	0.23	115.59	725.60		

Calculated Flow Parameters

Depth (ft)	Normal Flow (ft/sec)	Critical Flow (ft/sec)
0.29	3.58	3.19

Fish power required in outlet zone (watts)
 Fish energy required in outlet zone (joules)
 Fish power required at inlet (watts)
 Fish energy required at inlet (joules)

Normal Flow Supercritical | Supercritical flow in culvert

3-ft pipe at slope of existing d/s channel
 Juvenile Coho

Weak Swimming Fish Passage

Fish Length (mm)	Culvert (ft)	Slope (%)	Manning n	Q (cfs)	Culvert Diam. (ft)	Bed (ft)	Outlet (ft)	Depth (ft)
96	60	1.8	0.028	0.038	3	3	1	1.8

--- Fish Passage ---

Allowable Vel. (ft/sec)	Min. Flow Depth (ft)	Possible Power (watts)	Possible Energy (joules)	Outlet (ft)	Inlet (ft)
4.4	0.23	0.42	0.77		

Calculated Flow Parameters

Depth (ft)	Normal Flow (ft/sec)	Critical Flow (ft/sec)
0.40	2.59	3.19

Fish power required in outlet zone (watts)
 Fish energy required in outlet zone (joules)
 Fish power required at inlet (watts)
 Fish energy required at inlet (joules)

Acceptable Design

Adult Coho

Weak Swimming Fish Passage

Fish Length (mm)	Culvert (ft)	Slope (%)	Manning n	Q (cfs)	Culvert Diam. (ft)	Bed (ft)	Outlet (ft)	Depth (ft)
600	60	1.8	0.028	0.038	3	3	1	1.8

--- Fish Passage ---

Allowable Vel. (ft/sec)	Min. Flow Depth (ft)	Possible Power (watts)	Possible Energy (joules)	Outlet (ft)	Inlet (ft)
5.9	0.18	38.11	187.50		

Calculated Flow Parameters

Depth (ft)	Normal Flow (ft/sec)	Critical Flow (ft/sec)
0.40	2.59	3.19

Fish power required in outlet zone (watts)
 Fish energy required in outlet zone (joules)
 Fish power required at inlet (watts)
 Fish energy required at inlet (joules)

Normal Depth too shallow

Weak Swimming Fish Passage

Fish Length (mm)	Culvert (ft)	Slope (%)	Manning n	Q (cfs)	Culvert Diam. (ft)	Bed (ft)	Outlet (ft)	Depth (ft)
942	60	1.8	0.028	0.038	3	3	1	1.8

--- Fish Passage ---

Allowable Vel. (ft/sec)	Min. Flow Depth (ft)	Possible Power (watts)	Possible Energy (joules)	Outlet (ft)	Inlet (ft)
6.2	0.17	115.59	725.60		

Calculated Flow Parameters

Depth (ft)	Normal Flow (ft/sec)	Critical Flow (ft/sec)
0.40	2.59	3.19

Fish power required in outlet zone (watts)
 Fish energy required in outlet zone (joules)
 Fish power required at inlet (watts)
 Fish energy required at inlet (joules)

Normal Depth too shallow

barrier design:

3-ft pipe at slope of existing d/s channel
Juvenile Coho

Input Parameters:

Weak Swimming Fish Length (mm)	Slope (%)	Manning n Wall	Fish (cfs)	Flood (cfs)	Culvert Diameter (ft)
96	1.8	0.024	3	19	3

Calculated Parameters:

Water Velocity in small fish passage zone (ft/sec)	Fish power required at weir (watts)	Fish power capabilities (watts)	Depth of flow over weir (ft)	Depth of flow at outlet (ft)	Normal Depth at flood flow (ft)
2.81	0.18	0.26	0.68	0.98	1.90, 2.11

Status: Acceptable Design

Adult Coho

Input Parameters:

Weak Swimming Fish Length (mm)	Slope (%)	Manning n Wall	Fish (cfs)	Flood (cfs)	Culvert Diameter (ft)
600	1.8	0.024	3	19	3

Calculated Parameters:

Water Velocity in small fish passage zone (ft/sec)	Fish power required at weir (watts)	Fish power capabilities (watts)	Depth of flow over weir (ft)	Depth of flow at outlet (ft)	Normal Depth at flood flow (ft)
2.81	3.18	62.55	0.88	0.98	1.90, 2.11

Status: Acceptable Design

Adult coho - adjusted to 'equivalent' grayling

Input Parameters:

Weak Swimming Fish Length (mm)	Slope (%)	Manning n Wall	Fish (cfs)	Flood (cfs)	Culvert Diameter (ft)
942	1.8	0.024	3	19	3

Calculated Parameters:

Water Velocity in small fish passage zone (ft/sec)	Fish power required at weir (watts)	Fish power capabilities (watts)	Depth of flow over weir (ft)	Depth of flow at outlet (ft)	Normal Depth at flood flow (ft)
2.81	7.80	242.05	0.88	0.98	1.90, 2.11

Status: Acceptable Design

3-ft pipe at slope of existing pipe

Input Parameters:

Weak Swimming Fish Length (mm)	Slope (%)	Manning n Wall	Fish (cfs)	Flood (cfs)	Culvert Diameter (ft)
96	5	0.024	3	19	3

Calculated Parameters:

Water Velocity in small fish passage zone (ft/sec)	Fish power required at weir (watts)	Fish power capabilities (watts)	Depth of flow over weir (ft)	Depth of flow at outlet (ft)	Normal Depth at flood flow (ft)
4.14	0.24	0.26	0.56	0.86	1.57, 1.75

Status: Acceptable Design

Input Parameters:

Weak Swimming Fish Length (mm)	Slope (%)	Manning n Wall	Fish (cfs)	Flood (cfs)	Culvert Diameter (ft)
600	5	0.024	3	19	3

Calculated Parameters:

Water Velocity in small fish passage zone (ft/sec)	Fish power required at weir (watts)	Fish power capabilities (watts)	Depth of flow over weir (ft)	Depth of flow at outlet (ft)	Normal Depth at flood flow (ft)
4.14	7.93	62.55	0.56	0.86	1.57, 1.75

Status: Acceptable Design

Input Parameters:

Weak Swimming Fish Length (mm)	Slope (%)	Manning n Wall	Fish (cfs)	Flood (cfs)	Culvert Diameter (ft)
942	5	0.024	3	19	3

Calculated Parameters:

Water Velocity in small fish passage zone (ft/sec)	Fish power required at weir (watts)	Fish power capabilities (watts)	Depth of flow over weir (ft)	Depth of flow at outlet (ft)	Normal Depth at flood flow (ft)
4.14	20.26	242.05	0.56	0.86	1.57, 1.75

Status: Acceptable Design

2009 Alignment Station: 736+83

1 2006 S&HI Station 757+50 Tier 2 fish passage - 3-ft baffled CMP

CURRENT DATE: 09-07-2006
CURRENT TIME: 19:05:25

FILE DATE: 09-07-2006
FILE NAME: 757T2-3B

FHWA CULVERT ANALYSIS
HY-8, VERSION 6.1

C	SITE DATA		CULVERT SHAPE, MATERIAL, INLET						
U									
L	INLET	OUTLET	CULVERT	BARRELS					
V	ELEV.	ELEV.	LENGTH	SHAPE	SPAN	RISE	MANNING	INLET	
NO.	(ft)	(ft)	(ft)	MATERIAL	(ft)	(ft)	n	TYPE	
1	57.52	54.50	60.08	1 ICMP	3.00	2.55	.024	CONVENTIONAL	
2									
3									
4									
5									
6									

SUMMARY OF CULVERT FLOWS (cfs) FILE: 757T2-3B DATE: 09-07-2006

ELEV (ft)	TOTAL	1	2	3	4	5	6	ROADWA` ITR	
57.52	0	0	0	0	0	0	0	0	1
58	1.9	1.9	0	0	0	0	0	0	1
58.12	3	3	0	0	0	0	0	0	1
58.41	5.7	5.7	0	0	0	0	0	0	1
58.59	7.6	7.6	0	0	0	0	0	0	1
58.75	9.5	9.5	0	0	0	0	0	0	1
58.89	11.4	11.4	0	0	0	0	0	0	1
59.02	13.3	13.3	0	0	0	0	0	0	1
59.16	15.2	15.2	0	0	0	0	0	0	1
59.29	17.1	17.1	0	0	0	0	0	0	1
59.42	19	19	0	0	0	0	0	0	1
60.85	36.5	36.5	0	0	0	0	0	0 OVERTOF ING	

SUMMARY OF ITERATIVE SOLUTION ERRORS FILE: 757T2-3B DATE: 09-07-2006

HEAD ELEV (ft)	HEAD ERROR (ft)	TOTAL FLOW (cfs)	FLOW ERROR (cfs)	% FLOW ERROR
57.52	0.000	0.00	0.00	0.00
58.00	0.000	1.90	0.00	0.00
58.12	0.000	3.00	0.00	0.00
58.41	0.000	5.70	0.00	0.00
58.59	0.000	7.60	0.00	0.00
58.75	0.000	9.50	0.00	0.00
58.89	0.000	11.40	0.00	0.00
59.02	0.000	13.30	0.00	0.00
59.16	0.000	15.20	0.00	0.00
59.29	0.000	17.10	0.00	0.00
59.42	0.000	19.00	0.00	0.00

<1> TOLERANCE (ft) = 0.010

<2> TOLERANCE (%) = 1.000

2

CURRENT DATE: 09-07-2006
CURRENT TIME: 19:05:25

FILE DATE: 09-07-2006
FILE NAME: 757T2-3B

PERFORMANCE CURVE FOR CULVERT 1 - 1(3.00 (ft) BY 2.55 (ft)) ICMP

DIS- FLOW (cfs)	HEAD (ft)	INLET (ft)	OUTLET (ft)	CONTROL	CONTROL	FLOW (ft)	NORMAL (ft)	CRIT. (ft)	OUTLET TW (fps)	OUTLET TW (fps)
0.00	57.52	0.00	0.00	0-NF	0.00	0.00	0.00	-0.74	0.00	0.00
1.90	58.00	0.48	0.48	1-S2n	0.16	0.27	0.07	-0.45	6.38	1.86
3.00	58.12	0.60	0.60	1-S2n	0.26	0.36	0.16	-0.40	5.83	2.10
5.70	58.41	0.89	0.89	1-S2n	0.36	0.55	0.25	-0.30	9.54	2.55
7.60	58.59	1.07	1.07	1-S2n	0.44	0.66	0.36	-0.24	8.64	2.79
9.50	58.75	1.23	1.23	1-S2n	0.51	0.77	0.51	-0.19	7.47	3.01
11.40	58.89	1.37	1.37	1-S2n	0.57	0.86	0.46	-0.13	10.05	3.19
13.30	59.02	1.50	1.50	1-S2n	0.63	0.94	0.54	-0.08	9.71	3.36
15.20	59.16	1.64	1.64	1-S2n	0.68	1.03	0.63	-0.04	9.40	3.51
17.10	59.29	1.77	1.77	1-S2n	0.74	1.10	0.75	0.00	8.80	3.65
19.00	59.42	1.90	1.90	1-S2n	0.79	1.17	0.67	0.04	10.97	3.78

El. inlet face invert 57.52 ft El. outlet invert 54.50 ft
 El. inlet throat invert 0.00 ft El. inlet crest 0.00 ft

***** SITE DATA ***** CULVERT INVERT *****

INLET STATION 0.00 ft
 INLET ELEVATION 57.52 ft
 OUTLET STATION 60.00 ft
 OUTLET ELEVATION 54.50 ft
 NUMBER OF BARRELS 1
 SLOPE (V/H) 0.0503
 CULVERT LENGTH ALONG SLOPE 60.08 ft

***** CULVERT DATA SUMMARY *****

BARREL SHAPE USER DEFINED
 BARREL SPAN 3.00 ft
 BARREL RISE 2.55 ft
 BARREL MATERIAL STEEL OR ALUMINUM
 BARREL MANNING'S n 0.024 FOR SIDES AND TOP
 0.038 FOR BOTTOM
 INLET TYPE CONVENTIONAL
 INLET EDGE AND WALL MITERED
 INLET DEPRESSION NONE

3

CURRENT DATE: 09-07-2006

FILE DATE: 09-07-2006

CURRENT TIME: 19:05:25

FILE NAME: 757T2-3B

***** USER DEFINED CULVERT CROSS-SECTION - CULVERT # 1

COORDINATE NUMBER	X (ft)	Y-TOP (ft)	Y-BOTTOM (ft)
1	0.00	58.57	58.57
2	0.14	59.21	57.93
3	0.29	59.45	57.69
4	0.43	59.62	57.52
5	0.70	59.84	57.52
6	0.96	59.97	57.52
7	1.23	60.05	57.52
8	1.50	60.07	57.52
9	1.77	60.05	57.52
10	2.04	59.97	57.52
11	2.30	59.84	57.52
12	2.57	59.62	57.52
13	2.71	59.45	57.69
14	2.86	59.21	57.93
15	3.00	58.57	58.57

4

CURRENT DATE: 09-07-2006
CURRENT TIME: 19:05:25

FILE DATE: 09-07-2006
FILE NAME: 757T2-3B

TAILWATER

***** USER DEFINED CHANNEL CROSS-SECTION FILE NAME: 757T2-3B

MAIN CHANNEL ONLY FILE DATE: 09-07-2006
LEFT CHANNEL BOUNDARY 0
RIGHT CHANNEL BOUNDARY 0
MANNING n LEFT OVER BANK 0.000
MANNING n MAIN CHANNEL 0.038
MANNING n RIGHT OVER BANK 0.000
SLOPE OF CHANNEL 0.0180 ft/ft

CROSS-SECTION COORD. NO.	X (ft)	Y (ft)
1	0.00	57.61
2	3.40	53.76
3	6.50	53.82
4	10.20	53.91
5	12.80	57.07

***** UNIFORM FLOW RATING CURVE FOR DOWNSTREAM CHANNEL

FLOW (cfs)	W.S.E. (ft)	FROUDE NUMBER	DEPTH (ft)	VEL. (f/s)	SHEAR (psf)
0.00	53.76	0.000	-0.74	0.00	0.00
1.90	54.05	0.704	-0.45	1.86	0.24

3.00	54.10	0.724	-0.40	2.10	0.28
5.70	54.20	0.755	-0.30	2.55	0.38
7.60	54.26	0.770	-0.24	2.79	0.44
9.50	54.31	0.782	-0.19	3.01	0.49
11.40	54.37	0.792	-0.13	3.19	0.53
13.30	54.42	0.800	-0.08	3.36	0.58
15.20	54.46	0.807	-0.04	3.51	0.61
17.10	54.50	0.813	0.00	3.65	0.65
19.00	54.54	0.819	0.04	3.78	0.69

Note: Shear stress was calculated using R.

ROADWAY OVERTOPPING DATA

ROADWAY SURFACE	PAVED
EMBANKMENT TOP WIDTH	24.00 ft
CREST LENGTH	10.00 ft
OVERTOPPING CREST ELEVATION	60.85 ft

767+14

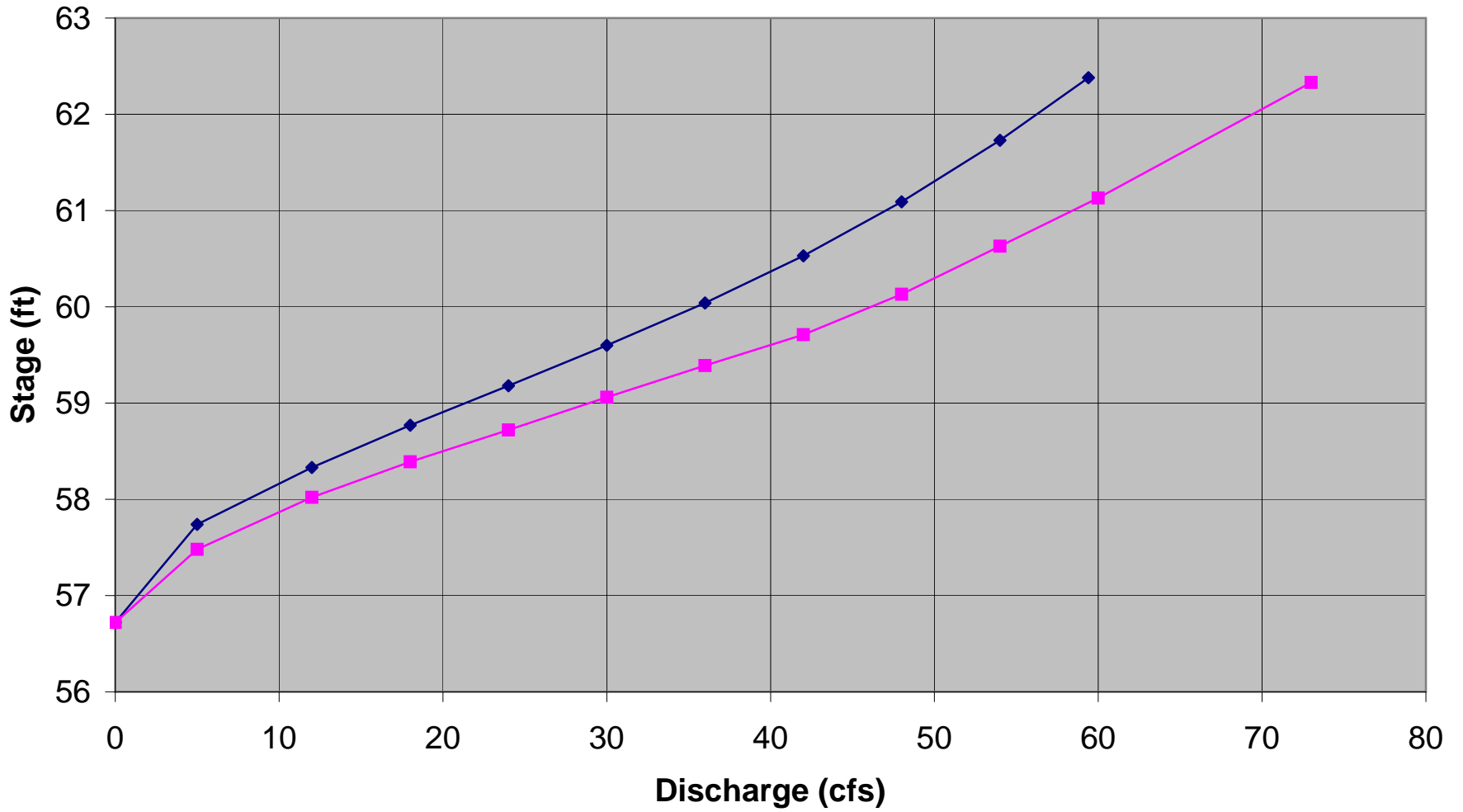

—◆— 787+50-Ex —■— 78750 - tier 2 bflld 3.5-ft cmp

2009 Alignment Station: 767+14

1 2006 S&HI Station 787+50 Existing conditions

CURRENT DATE: 08-25-2006
CURRENT TIME: 16:45:22

FILE DATE: 08-25-2006
FILE NAME: 78750EX

FHWA CULVERT ANALYSIS
HY-8, VERSION 6.1

C SITE DATA CULVERT SHAPE, MATERIAL, INLET
U
L INLET OUTLET CULVERT BARRELS
V ELEV. ELEV. LENGTH SHAPE SPAN RISE MANNING INLET
NO. (ft) (ft) (ft) MATERIAL (ft) (ft) n TYPE
1 56.72 55.16 52.02 1 CSP 3.00 3.00 .024 CONVENTIONAL
2
3
4
5
6

SUMMARY OF CULVERT FLOWS (cfs) FILE: 78750EX DATE: 08-25-2006

ELEV (ft)	TOTAL	1	2	3	4	5	6 ROADWAY	ITR
56.72	0	0	0	0	0	0	0	1
57.74	5	5	0	0	0	0	0	1
58.33	12	12	0	0	0	0	0	1
58.77	18	18	0	0	0	0	0	1
59.18	24	24	0	0	0	0	0	1
59.6	30	30	0	0	0	0	0	1
60.04	36	36	0	0	0	0	0	1
60.53	42	42	0	0	0	0	0	1
61.09	48	48	0	0	0	0	0	1
61.73	54	54	0	0	0	0	0	1
62.38	60	59.4	0	0	0	0	0.32	6
62.33	59	59	0	0	0	0	0 OVERTOPP	ING

SUMMARY OF ITERATIVE SOLUTION ERRORS FILE: 78750EX DATE: 08-25-2006

HEAD ELEV (ft)	HEAD ERROR (ft)	TOTAL FLOW (cfs)	FLOW ERROR (cfs)	% FLOW ERROR
56.72	0.000	0.00	0.00	0.00
57.74	0.000	5.00	0.00	0.00
58.33	0.000	12.00	0.00	0.00
58.77	0.000	18.00	0.00	0.00
59.18	0.000	24.00	0.00	0.00
59.60	0.000	30.00	0.00	0.00
60.04	0.000	36.00	0.00	0.00
60.53	0.000	42.00	0.00	0.00
61.09	0.000	48.00	0.00	0.00
61.73	0.000	54.00	0.00	0.00
62.38	-0.008	60.00	0.23	0.38

<1> TOLERANCE (ft) = 0.010

<2> TOLERANCE (%) = 1.000

2

CURRENT DATE: 08-25-2006
CURRENT TIME: 16:45:22

FILE DATE: 08-25-2006
FILE NAME: 78750EX

PERFORMANCE CURVE FOR CULVERT 1 - 1(3.00 (ft) BY 3.00 (ft)) CSP

DIS- FLOW (cfs)	HEAD (ft)	INLET (ft)	OUTLET (ft)	CONTROL <F4>	CONTROL (ft)	FLOW TYPE (ft)	NORMAL DEPTH (ft)	CRIT. DEPTH (fps)	OUTLET DEPTH (ft)	TW DEPTH (ft)	OUTLET DEPTH (ft)	TW VEL. (fps)
--------------------	-----------	------------	-------------	--------------	--------------	----------------	-------------------	-------------------	-------------------	---------------	-------------------	---------------

0.00	56.72	0.00	0.00	0-NF	0.00	0.00	0.00	0.34	0.00	0.00		
5.00	57.74	1.02	1.02	1-S2n	0.56	0.69	0.49	0.34	6.52	0.00		
12.00	58.33	1.61	1.61	1-S2n	0.89	1.09	0.79	0.34	8.00	0.00		
18.00	58.77	2.05	2.05	1-S2n	1.09	1.35	1.10	0.34	7.64	0.00		
24.00	59.18	2.46	2.46	1-S2n	1.28	1.57	1.17	0.34	9.36	0.00		
30.00	59.60	2.88	2.88	1-S2n	1.46	1.77	1.37	0.34	9.51	0.00		
36.00	60.04	3.32	3.32	5-S2n	1.63	1.94	1.54	0.34	9.82	0.00		
42.00	60.53	3.81	3.81	5-S2n	1.80	2.11	1.71	0.34	10.10	0.00		
48.00	61.09	4.37	4.37	5-S2n	1.97	2.25	1.98	0.34	9.72	0.00		
54.00	61.73	5.01	5.01	5-S2n	2.15	2.38	2.08	0.34	10.30	0.00		
59.44	62.38	5.66	5.66	5-S2n	2.34	2.48	2.28	0.34	10.35	0.00		

El. inlet face invert 56.72 ft El. outlet invert 55.16 ft
 El. inlet throat invert 0.00 ft El. inlet crest 0.00 ft

***** SITE DATA ***** CULVERT INVERT *****

INLET STATION 0.00 ft
 INLET ELEVATION 56.72 ft
 OUTLET STATION 52.00 ft
 OUTLET ELEVATION 55.16 ft
 NUMBER OF BARRELS 1
 SLOPE (V/H) 0.0300
 CULVERT LENGTH ALONG SLOPE 52.02 ft

***** CULVERT DATA SUMMARY *****

BARREL SHAPE CIRCULAR
 BARREL DIAMETER 3.00 ft
 BARREL MATERIAL CORRUGATED STEEL
 BARREL MANNING'S n 0.024
 INLET TYPE CONVENTIONAL
 INLET EDGE AND WALL THIN EDGE PROJECTING
 INLET DEPRESSION NONE

3

CURRENT DATE: 08-25-2006
CURRENT TIME: 16:45:22

FILE DATE: 08-25-2006
FILE NAME: 78750EX

TAILWATER

CONSTANT WATER SURFACE ELEVATION
55.5

ROADWAY OVERTOPPING DATA

ROADWAY SURFACE	PAVED
EMBANKMENT TOP WIDTH	24.00 ft
CREST LENGTH	10.00 ft
OVERTOPPING CREST ELEVATION	62.33 ft

Non baffle design

Juvenile coho in 3-ft CMP

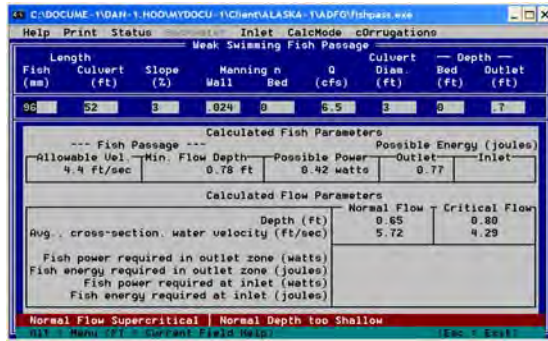

adult coho

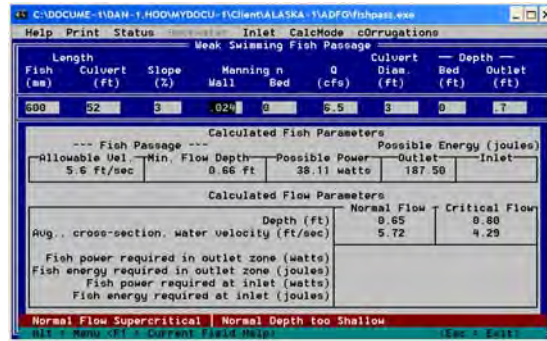

Baffle design

Juvenile coho in 3-ft CMP

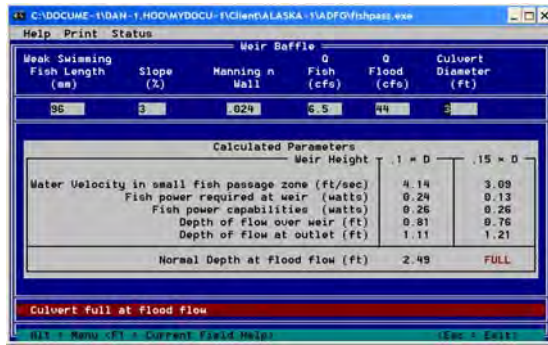

Juvenile coho in 3.5-ft CMP

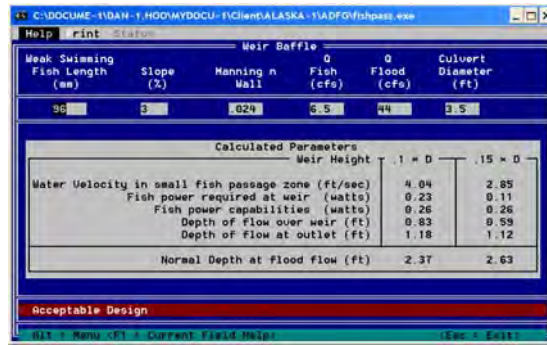

Adult coho in 3.5-ft CMP

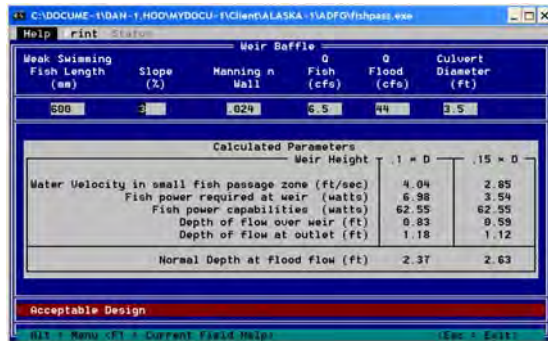

Adult coho adjusted to 'equivalent' grayling

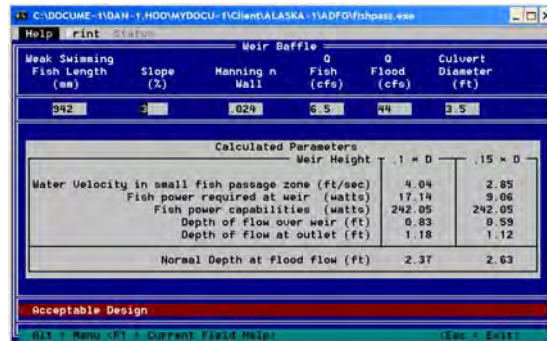

2009 Alignment Station: 767+14

1 2006 S&HI Station 787+50 Tier 2 fish passage - 3.5-ft baffled CMP

CURRENT DATE: 09-07-2006
CURRENT TIME: 19:53:59

FILE DATE: 09-07-2006
FILE NAME: 787T2-42

FHWA CULVERT ANALYSIS
HY-8, VERSION 6.1

C	SITE DATA		CULVERT SHAPE, MATERIAL, INLET						
U									
L	INLET	OUTLET	CULVERT	BARRELS					
V	ELEV.	ELEV.	LENGTH	SHAPE	SPAN	RISE	MANNING	INLET	
NO.	(ft)	(ft)	(ft)	MATERIAL	(ft)	(ft)	n	TYPE	
1	56.72	55.16	52.02	1 ICMP	3.50	2.98	.024	CONVENTIONAL	
2									
3									
4									
5									
6									

SUMMARY OF CULVERT FLOWS (cfs) FILE: 787T2-42 DATE: 09-07-2006

ELEV (ft)	TOTAL	1	2	3	4	5	6	ROADWAY	INTR
56.72	0	0	0	0	0	0	0	0	1
57.48	5	5	0	0	0	0	0	0	1
58.02	12	12	0	0	0	0	0	0	1
58.39	18	18	0	0	0	0	0	0	1
58.72	24	24	0	0	0	0	0	0	1
59.06	30	30	0	0	0	0	0	0	1
59.39	36	36	0	0	0	0	0	0	1
59.71	42	42	0	0	0	0	0	0	1
60.13	48	48	0	0	0	0	0	0	1
60.63	54	54	0	0	0	0	0	0	1
61.13	60	60	0	0	0	0	0	0	1
62.33	73	73	0	0	0	0	0	0	OVERFLOWING

SUMMARY OF ITERATIVE SOLUTION ERRORS FILE: 787T2-42 DATE: 09-07-2006

HEAD	HEAD	TOTAL	FLOW	% FLOW
ELEV (ft)	ERROR (ft)	FLOW (cfs)	ERROR (cfs)	ERROR
56.72	0.000	0.00	0.00	0.00
57.48	0.000	5.00	0.00	0.00
58.02	0.000	12.00	0.00	0.00
58.39	0.000	18.00	0.00	0.00
58.72	0.000	24.00	0.00	0.00
59.06	0.000	30.00	0.00	0.00
59.39	0.000	36.00	0.00	0.00
59.71	0.000	42.00	0.00	0.00
60.13	0.000	48.00	0.00	0.00
60.63	0.000	54.00	0.00	0.00
61.13	0.000	60.00	0.00	0.00

<1> TOLERANCE (ft) = 0.010

<2> TOLERANCE (%) = 1.000

2

CURRENT DATE: 09-07-2006
CURRENT TIME: 19:53:59

FILE DATE: 09-07-2006
FILE NAME: 787T2-42

PERFORMANCE CURVE FOR CULVERT 1 - 1(3.50 (ft) BY 2.98 (ft)) ICMP

DIS- FLOW (cfs)	HEAD (ft)	INLET (ft)	OUTLET (ft)	CONTROL	CONTROL	FLOW TYPE	NORMAL DEPTH (ft)	CRIT. DEPTH (ft)	OUTLET TW (fps)	OUTLET TW DEPTH (ft)
0.00	56.72	0.00	0.00	0-NF	0.00	0.00	0.00	0.34	0.00	0.00
5.00	57.48	0.76	0.76	1-S2n	0.36	0.46	0.26	0.34	6.24	0.00
12.00	58.02	1.30	1.30	1-S2n	0.63	0.81	0.51	0.34	8.17	0.00
18.00	58.39	1.67	1.67	1-S2n	0.81	1.04	0.74	0.34	8.07	0.00
24.00	58.72	2.00	2.00	1-S2n	0.97	1.25	0.97	0.34	8.04	0.00
30.00	59.06	2.34	2.34	1-S2n	1.13	1.43	1.03	0.34	9.44	0.00
36.00	59.39	2.67	2.67	1-S2n	1.27	1.59	1.19	0.34	9.63	0.00
42.00	59.71	2.99	2.99	5-S2n	1.41	1.75	1.35	0.34	9.81	0.00
48.00	60.13	3.41	3.41	5-S2n	1.56	1.89	1.49	0.34	10.06	0.00
54.00	60.63	3.91	3.91	5-S2n	1.70	2.03	1.63	0.34	10.33	0.00
60.00	61.13	4.41	4.41	5-S2n	1.84	2.15	1.75	0.34	10.66	0.00

El. inlet face invert 56.72 ft El. outlet invert 55.16 ft
 El. inlet throat invert 0.00 ft El. inlet crest 0.00 ft

***** SITE DATA ***** CULVERT INVERT *****

INLET STATION 0.00 ft
 INLET ELEVATION 56.72 ft
 OUTLET STATION 52.00 ft
 OUTLET ELEVATION 55.16 ft
 NUMBER OF BARRELS 1
 SLOPE (V/H) 0.0300
 CULVERT LENGTH ALONG SLOPE 52.02 ft

***** CULVERT DATA SUMMARY *****

BARREL SHAPE USER DEFINED
 BARREL SPAN 3.50 ft
 BARREL RISE 2.98 ft
 BARREL MATERIAL STEEL OR ALUMINUM
 BARREL MANNING'S n 0.024 FOR SIDES AND TOP
 0.038 FOR BOTTOM
 INLET TYPE CONVENTIONAL
 INLET EDGE AND WALL MITERED
 INLET DEPRESSION NONE

3

CURRENT DATE: 09-07-2006

FILE DATE: 09-07-2006

CURRENT TIME: 19:53:59

FILE NAME: 787T2-42

***** USER DEFINED CULVERT CROSS-SECTION - CULVERT # 1

COORDINATE NUMBER	X (ft)	Y-TOP (ft)	Y-BOTTOM (ft)
1	0.00	57.95	57.95
2	0.17	58.69	57.20
3	0.33	58.97	56.92
4	0.50	59.17	56.72
5	0.81	59.42	56.72
6	1.13	59.58	56.72
7	1.44	59.67	56.72
8	1.75	59.70	56.72
9	2.06	59.67	56.72
10	2.37	59.58	56.72
11	2.69	59.42	56.72
12	3.00	59.17	56.72
13	3.17	58.97	56.92
14	3.33	58.69	57.20
15	3.50	57.95	57.95

4

CURRENT DATE: 09-07-2006
CURRENT TIME: 19:53:59

FILE DATE: 09-07-2006
FILE NAME: 787T2-42

TAILWATER

CONSTANT WATER SURFACE ELEVATION
55.5

ROADWAY OVERTOPPING DATA

ROADWAY SURFACE	PAVED
EMBANKMENT TOP WIDTH	24.00 ft
CREST LENGTH	10.00 ft
OVERTOPPING CREST ELEVATION	62.33 ft

APPENDIX D

Stream Habitat Mitigation Plan



Technical Memorandum

Project Name:

Regarding: Haines Highway Conceptual Mitigation Opportunities

From: Dan Miller and Mark Sogge

Date: July 30, 2009,

Revised: September 17, 2010
January 6, 2012

Background

This memorandum provides a description of each of the mitigation sites shown in the companion graphics Haines Highway – MP 3.5 to 25.3 Conceptual Mitigation Opportunities dated October 28, 2009. The purpose of this narrative and plan set is to describe the potential mitigation opportunities related to the proposed realignment and widening of the Haines Highway.

A number of environmental and habitat specific tasks have been completed on the Haines Highway project. DOWL HKM has completed a Wetlands Delineation Report (2006) for the highway corridor. Inter-Fluve has completed a Stream and Habitat Inventory (2006) of stream crossings of the highway and locations where the Chilkat River and side channels flow along the road embankment. Inter-Fluve has also completed a draft Hydrology and Hydraulics Report (2009) of stream culvert crossings of the highway; assessment of Chilkat River and side channels where they flow near the road embankment; and, preliminary design of fish passage culverts. The reader is directed to these respective reports for details.

Through these various studies and focused consideration of mitigation opportunities along the project corridor, a number of sites with opportunities to enhance or create aquatic habitats along the project corridor were identified. The opportunities were discussed with DOT&PF staff and first presented to an IDT in July 2006, and again in March 2009. These opportunities have undergone additional field evaluation and preliminary survey. The following is a discussion of mitigation opportunity concepts as shown on the companion plan set. These were developed based on existing stream reference conditions and professional judgment of the project team and DOT&PF staff. Rough planning level construction estimates are included.

These conceptual designs will undergo further refinement during the creation of construction ready design documents. Additional design work will require the involvement of personnel that possess expertise in engineering, fisheries biology, and fluvial geomorphology. The designs will consider, at a minimum, biology, hydrology, hydraulics, topography, sediment transport, and

fluvial geomorphology. The intent of the designs will be to create a complex habitat which is appropriate to each site's geomorphic conditions and is as naturally sustainable as possible.

State of Alaska Department of Transportation and Public Facilities

Haines Highway - MP 3.5 to MP 25.3 Conceptual Mitigation Opportunities



STATE OF ALASKA VICINITY MAP

SHEET INDEX

- 1 Conceptual Mitigation Opportunities Cover, Sheet Index and Vicinity Map
- 2 Sheet Index
- 3 *Conceptual Mitigation Opportunities Site 241+30*
- 4 *Conceptual Mitigation Opportunities Site 241+30*
- 5 *Conceptual Mitigation Opportunities Site 319+13*
- 6 *Conceptual Mitigation Opportunities Site 513+75*
- 7 *Conceptual Mitigation Opportunities Site 513+75*
- 8 *Conceptual Mitigation Opportunities Site 532+00*
- 9 *Conceptual Mitigation Opportunities Site 608+00*
- 10 *Conceptual Mitigation Opportunities Site 647+20*
- 11 *Conceptual Mitigation Opportunities Site 647+20*
- 12 *Conceptual Mitigation Opportunities Site 736+83*
- 13 *Conceptual Mitigation Opportunities Site 736+83*
- 14 *Conceptual Mitigation Opportunities Site 736+83*
- 15 *Conceptual Mitigation Opportunities Site 869+00*
- 16 *Conceptual Mitigation Opportunities Site 869+00*
- 17 *Conceptual Mitigation Opportunities Site 895+00*
- 18 *Conceptual Mitigation Opportunities Site 895+00*
- 19 *Conceptual Mitigation Opportunities - Mud Bay*
- 20 *Conceptual Mitigation Opportunities - Mud Bay*
- 21 *Conceptual Mitigation Opportunities - Mud Bay*

**CHANGES RESULTING
FROM IDT MEETING AND
COMMENTS JUNE 2013**

PRELIMINARY

1	DM	1/5/12	
2	RS	1/17/13	PLAN UPDATES BY DOWL HKM
NO.	BY	DATE	REVISION DESCRIPTION

RP	DM, MS	DM
DRAWN	DESIGNED	CHECKED
DM	10/28/09	
APPROVED	DATE	PROJECT

State of Alaska Department of Transportation
and Public Facilities – Haines, Alaska
Haines Highway – MP 3.5 to 25.3



1020 Wasco Street, Suite 1
Hood River, OR 97031
541.386.9003
www.interfluve.com

Conceptual Mitigation Opportunities
Cover, Sheet Index and Vicinity Map

SHEET
1 of 21

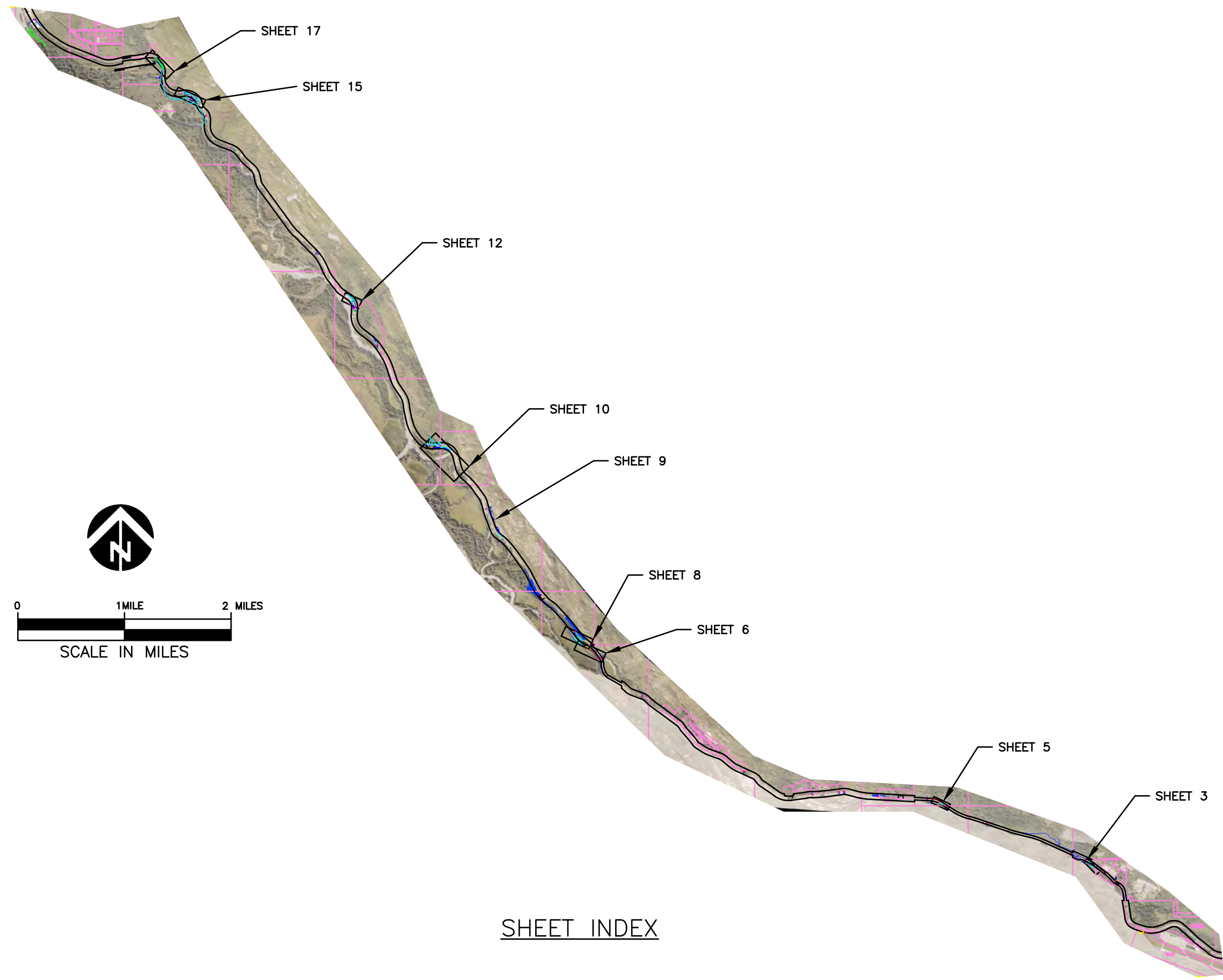

SHEET INDEX

NO.	BY	DATE	REVISION DESCRIPTION
1	DM	1/5/12	
2	RS	1/17/13	PLAN UPDATES BY DOWL HKM

RP	DM, MS	DM
DRAWN	DESIGNED	CHECKED
DM	10/28/09	
APPROVED	DATE	PROJECT

State of Alaska Department of Transportation
and Public Facilities – Haines, Alaska
Haines Highway – MP 3.5 to 25.3



1020 Wasco Street, Suite 1
Hood River, OR 97031
541.386.9003
www.interfluve.com

Conceptual Mitigation Opportunities
Sheet Index

SHEET
2 of 21

Station 240+38

This site is shown on Sheets 3 and 4. The stream passes through a 24 inch culvert then flows approximately 150 to 250 feet along the toe of the existing road embankment before diffusing through the forest to join up with a well defined slough channel. The left bank is maintained by DOT&PF and has limited riparian vegetation.

The proposed plan is to move the stream off the road embankment toe by the creation of approximately 200 feet of new stream. The new stream would be directed through the forest and join up with the existing slough channel. The marsh like condition of the forest would not be changed with flow continuing to diffuse through a complex flow pattern. Construction would be selectively conducted in order to preserve root structure as a component of the new stream, matching the conditions in the existing stream. Supplemental woody debris would be incorporated into the channel at selected locations. The new stream will provide rearing habitat for juvenile fish.

A rough planning level construction cost for this option is \$40,000.

Table 1. Habitat Loss and Gain at Station 240+38

Existing Stream Conditions (length)	Proposed Stream Enhancements (length)
24" culvert; channel 150-250' length along highway toe of slope; left bank has limited riparian vegetation.	Create 200' of new channel away from highway toe of slope; woody debris added, riparian vegetation encouraged on both banks, rearing habitat. New Tier 2 fish passage culvert.



PLAN VIEW: PROPOSED CONDITIONS 241+30

1	DM	1/5/12	
2	RS	1/17/13	PLAN UPDATES BY DOWL HKM
NO.	BY	DATE	REVISION DESCRIPTION

RP	DM, MS	DM
DRAWN	DESIGNED	CHECKED
DM	10/28/09	
APPROVED	DATE	PROJECT

State of Alaska Department of Transportation
and Public Facilities - Haines, Alaska
Haines Highway - MP 3.5 to 25.3



1020 Wasco Street, Suite 1
Hood River, OR 97031
541.386.9003
www.interfluve.com

Conceptual Mitigation Opportunities
Site 241+30

SHEET
3 of 21

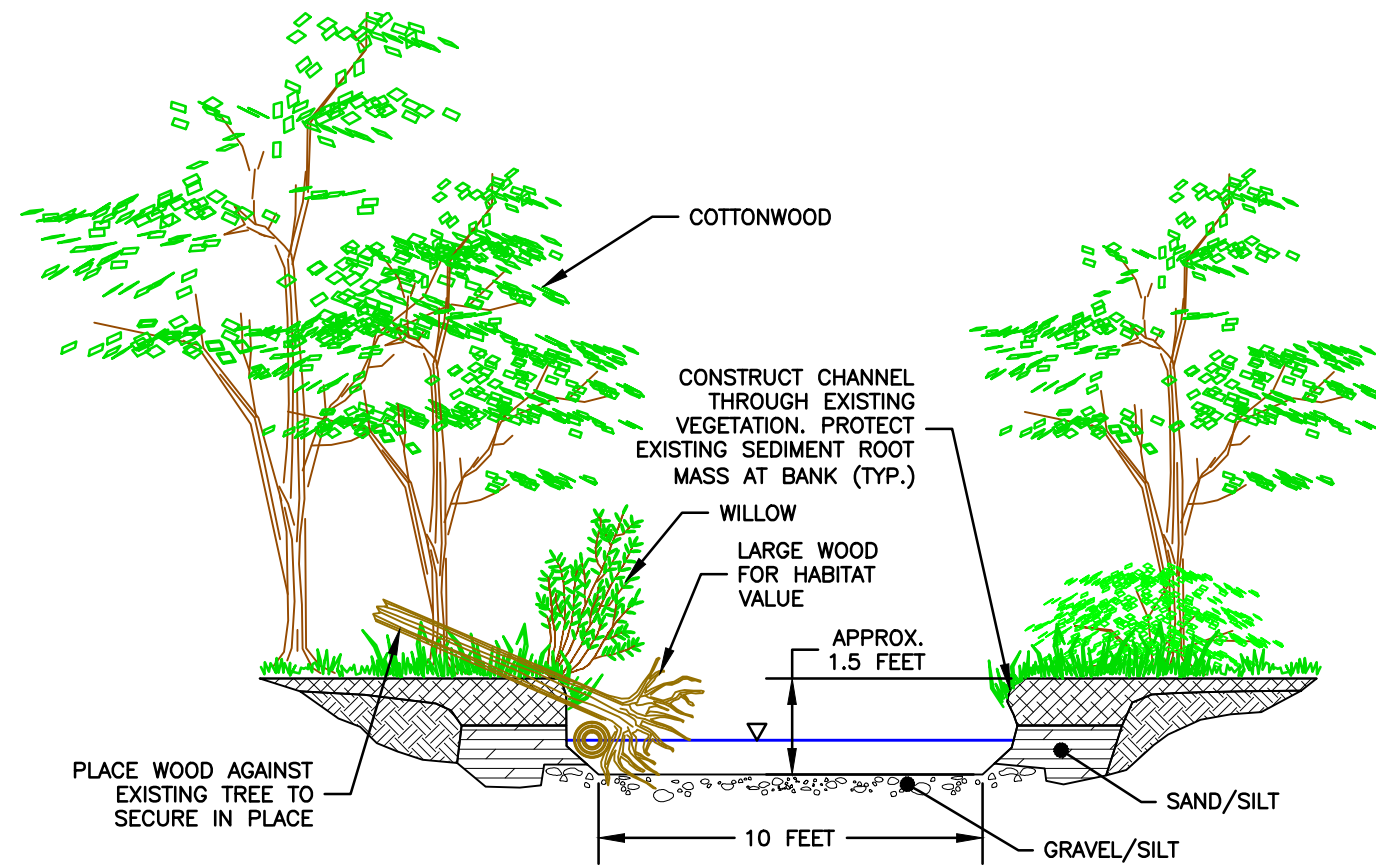

TYPICAL SECTION: SITE 241+30
NOT TO SCALE

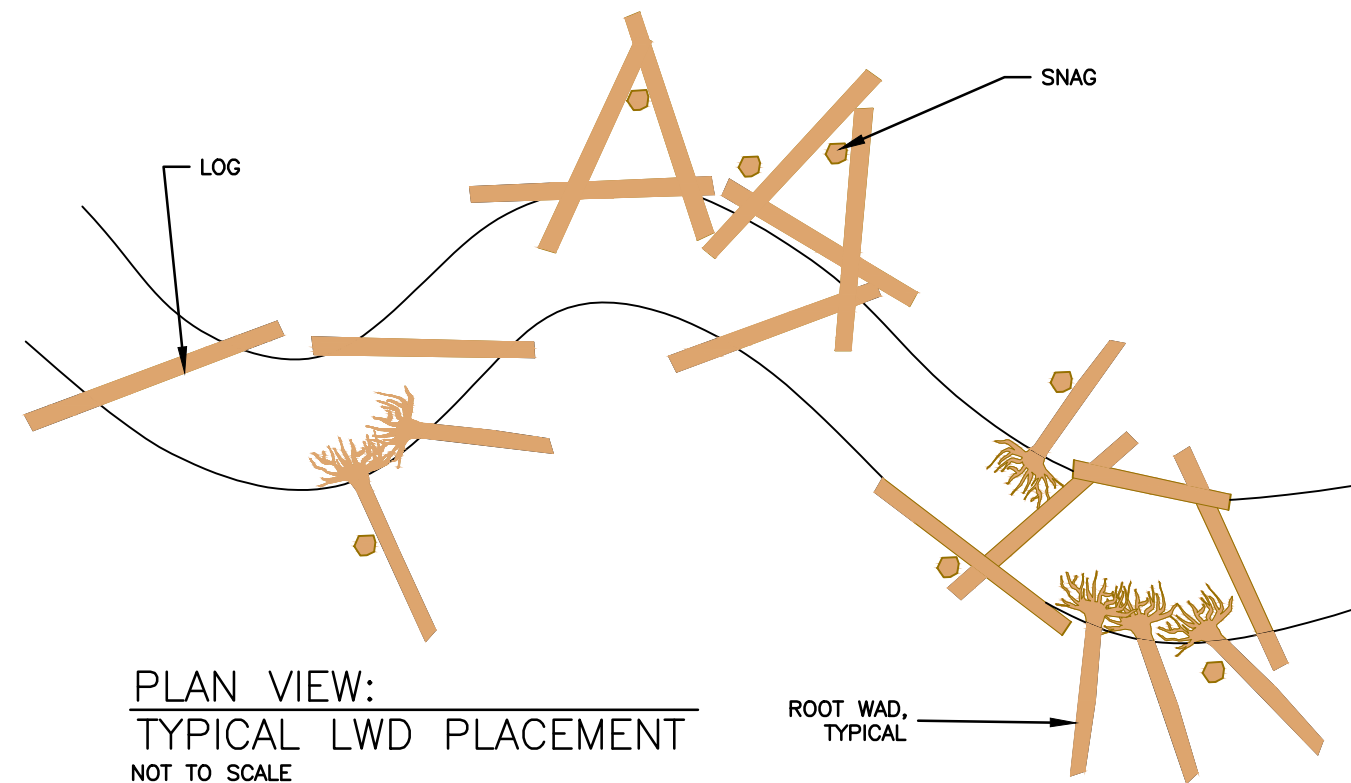

PLAN VIEW:
TYPICAL LWD PLACEMENT
NOT TO SCALE

1	DM	1/5/12	
2	RS	1/17/13	PLAN UPDATES BY DOWL HKM
NO.	BY	DATE	REVISION DESCRIPTION

RP	DM, MS	DM
DRAWN	DESIGNED	CHECKED
DM	10/28/09	
APPROVED	DATE	PROJECT

State of Alaska Department of Transportation
and Public Facilities – Haines, Alaska
Haines Highway – MP 3.5 to 25.3



1020 Wasco Street, Suite 1
Hood River, OR 97031
541.386.9003
www.interfluve.com

Conceptual Mitigation Opportunities
Site 241+30

SHEET
4 of 21

Station 512+24

This location is shown on Sheet 6 and 7. Presently the stream flows through a relic side channel of the Chilkat River and along approximately 1000 feet along the toe of the existing road embankment. This stream floods the full width of the relic side channel and flows very slowly through the thick aquatic vegetation. This area is classified as an Herbaceous Swamp in the Wetlands Delineation Report and the vegetation is primarily swamp horsetail (*Equisetum fluviatile*) and sedges (*Carex sp.*). There is no defined stream channel. The water depth within the channel is influence by the stage of the Chilkat River, and the stream often has the appearance of more of a slough than an actively flowing stream. The left bank is maintained by DOT&PF and has limited riparian vegetation.

The proposed plan is to relocate the stream away from the road embankment toe by the creation of approximately 1000 feet of new stream. The new stream would be routed along the alignment of a relic gravel bar and through a slot in the existing cottonwood forest. Some cottonwood trees will have to be removed to provide adequate width for the channel construction. There are no known eagle nests in this area and during a 2009 field visit with personnel from the Alaska Department of Natural Resources, Parks Division none of the trees proposed for removal were seen as important eagle perching trees. These trees can be utilized to provide woody debris within the new stream channel. The new channel cross section matches the existing channel conditions and will revegetate and function in a similar manner. The grade of the channel will allow the continued backwatering of the stream. The well vegetated, deep clear water habitat will provide ideal rearing habitat for juvenile fish.

Sheet 7 shows two options for creating the new channel using either biodegradable fabric encapsulated soil lifts or woody debris to form the banks. A combination of these two methods would provide shoreline habitat diversity. The placement of woody debris within the channel will provide initial cover for juvenile fish, with the primary cover resulting from the establishment of a well vegetated channel. The vegetation will determine the primary flow path through the broad channel. Existing vegetation on the new stream banks will be left undisturbed to the extent possible in order to provide immediate healthy riparian conditions. Willow will be planted where existing vegetation is not present.

A small stream that currently enters the slough near station 523+75 will not be directly affected by the realignment of the channel as designed. It will continue to flow into the slough at its present location. Juvenile fish will be able to access this stream in the manner they currently do.

Some of the material excavated from the new stream alignment will be utilized to create a channel block across the current slough and to direct flows into the new stream. Excess material from the realignment project could potentially be used for this fill as well with the need to add a fine grained material core to limit excess drainage considered during the

design phase.

A rough planning level construction cost for this option is \$150,000.

Table 3. Habitat Loss and Gain at Station 512+24

Existing Stream Conditions (length)	Proposed Stream Enhancements (length)
1000' of stream follows relic side channel of river along toe of existing road embankment; at high water, slow flows through thick aquatic vegetation (swamp horsetail and sedges), slough-like; limited riparian vegetation on left bank.	Create 1000' of new stream channel away from highway toe of slope; located on relic gravel bar for substrate, placement of woody debris, low gradient deep water channel will provide rearing habitat. New Tier 1 fish passage culvert will be installed.

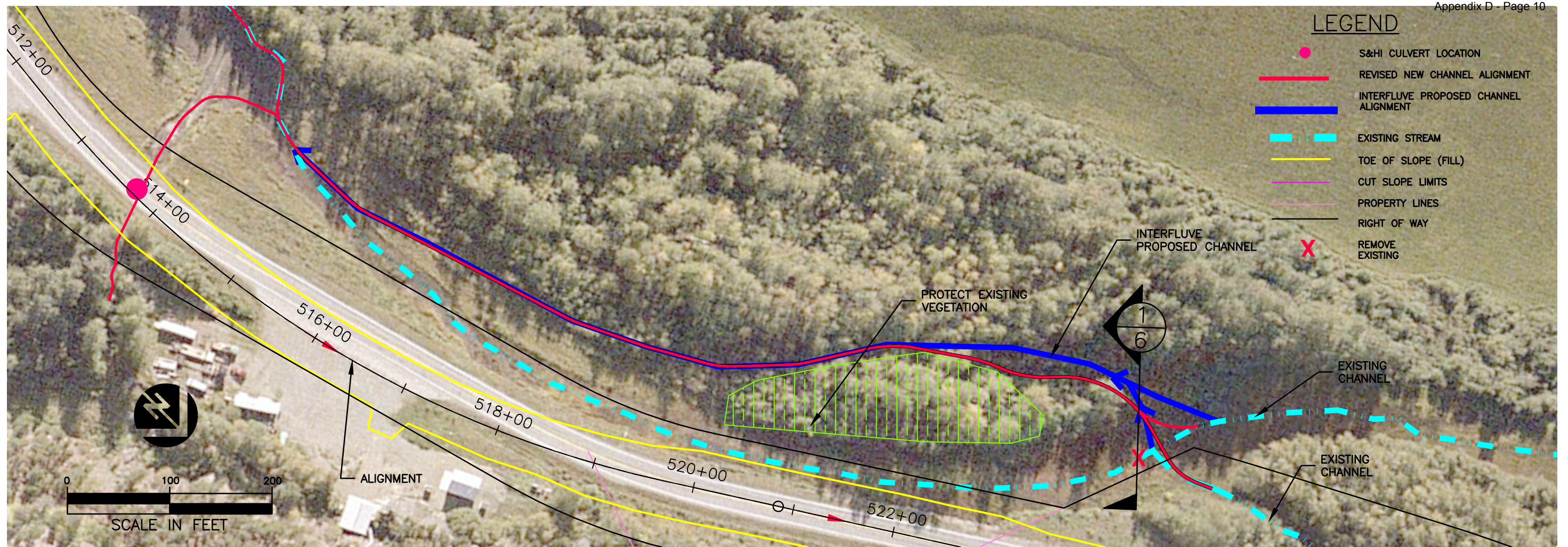

PLAN VIEW

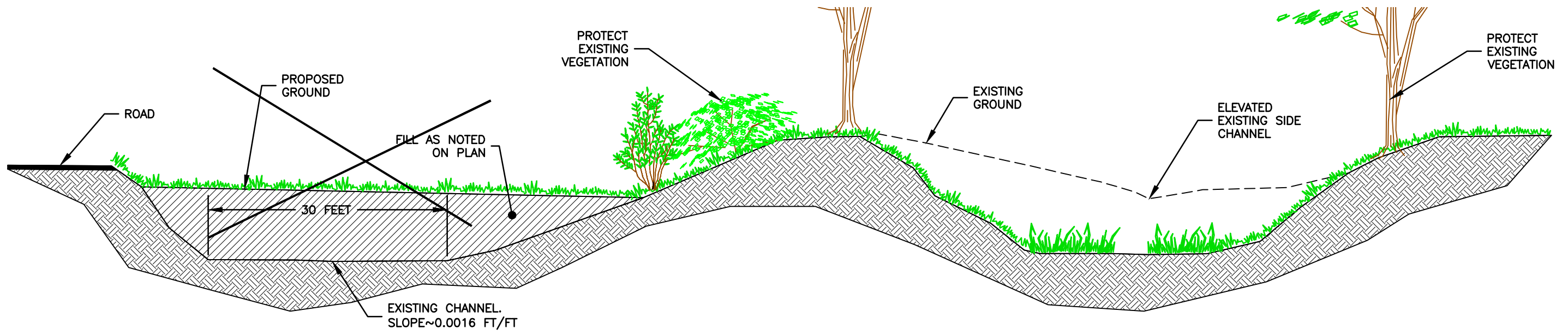

1/6 TYPICAL SECTION: CUT/FILL LOOKING DOWNSTREAM SITE 513+75
NOT TO SCALE

1	DM	1/5/12	
2	RS	1/17/13	PLAN UPDATES BY DOWL HKM
NO.	BY	DATE	REVISION DESCRIPTION

RP	DM, MS	DM
DRAWN	DESIGNED	CHECKED
DM	10/28/09	
APPROVED	DATE	PROJECT

State of Alaska Department of Transportation
and Public Facilities - Haines, Alaska
Haines Highway - MP 3.5 to 25.3



1020 Wasco Street, Suite 1
Hood River, OR 97031
541.386.9003
www.interfluve.com

Conceptual Mitigation Opportunities
Site 513+75

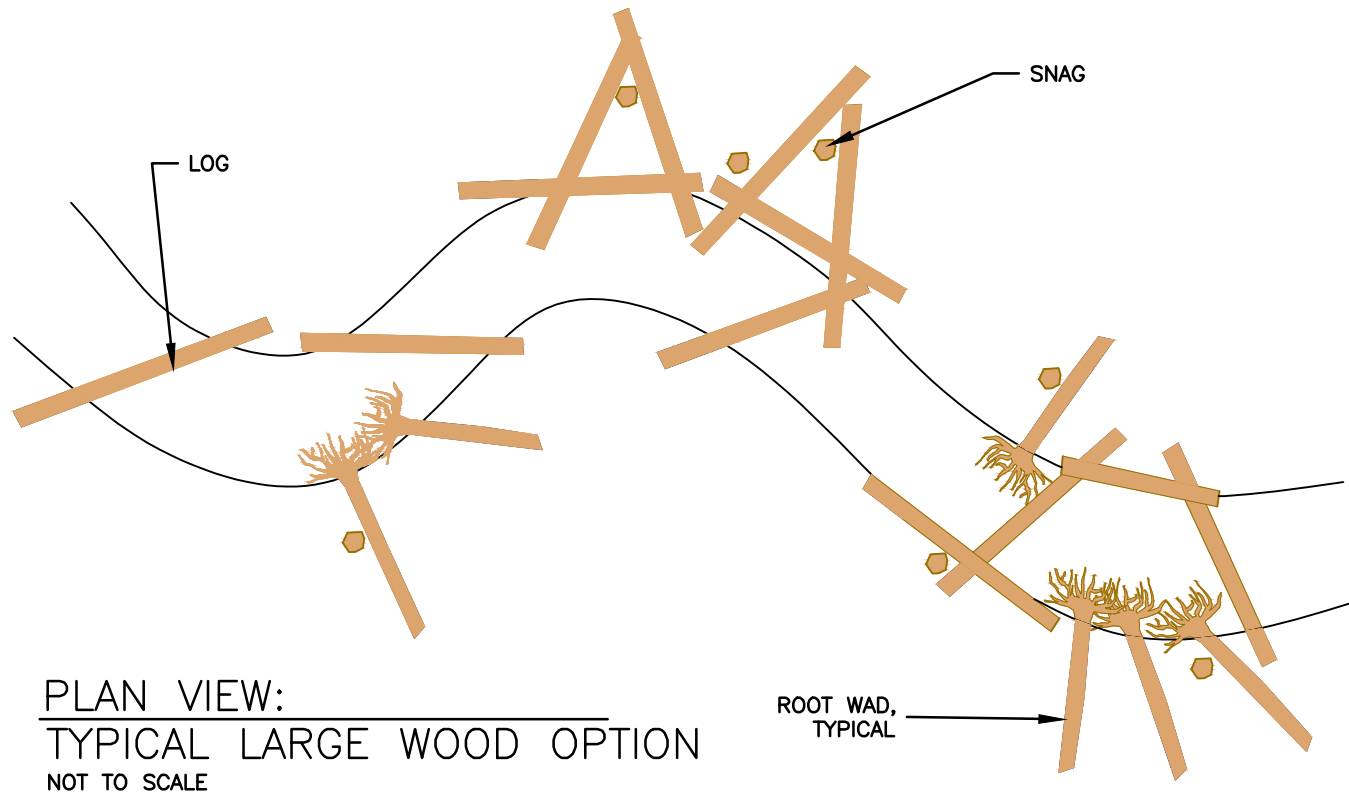

PLAN VIEW:
TYPICAL LARGE WOOD OPTION
NOT TO SCALE

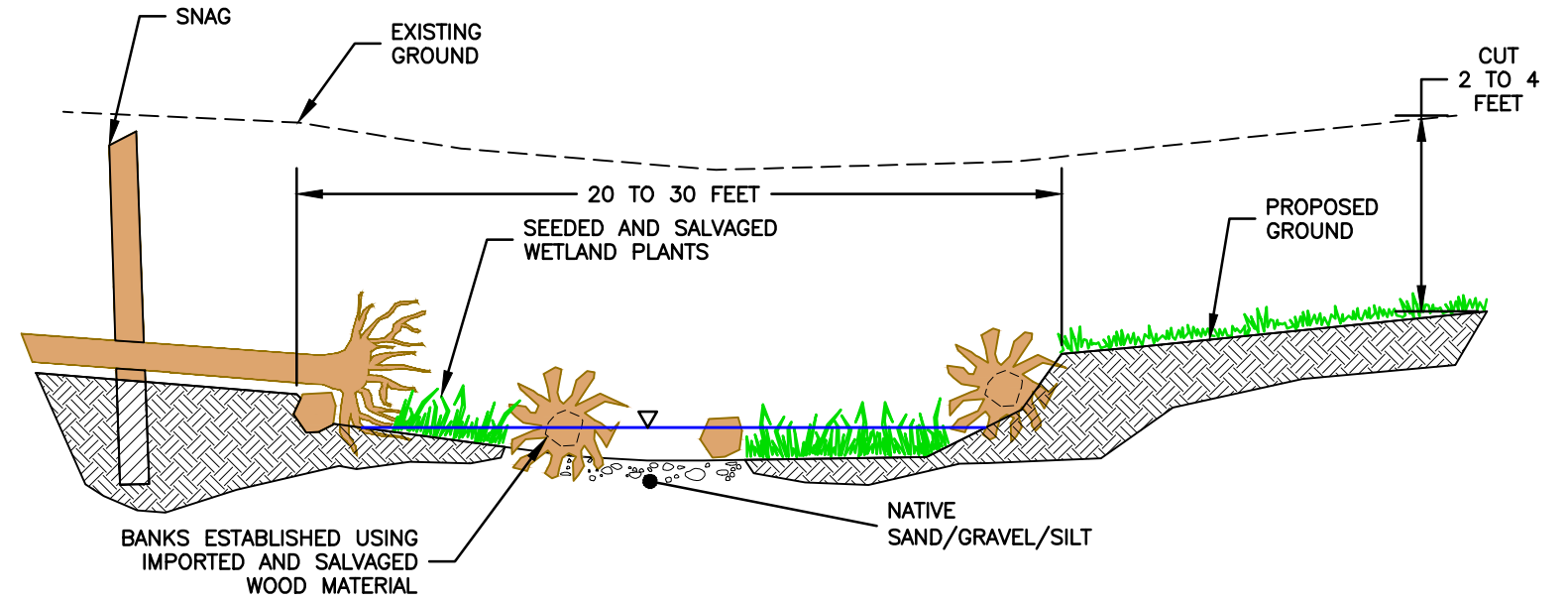

CROSS-SECTION:
NEW CHANNEL CONSTRUCTION – LARGE WOOD OPTION
NOT TO SCALE

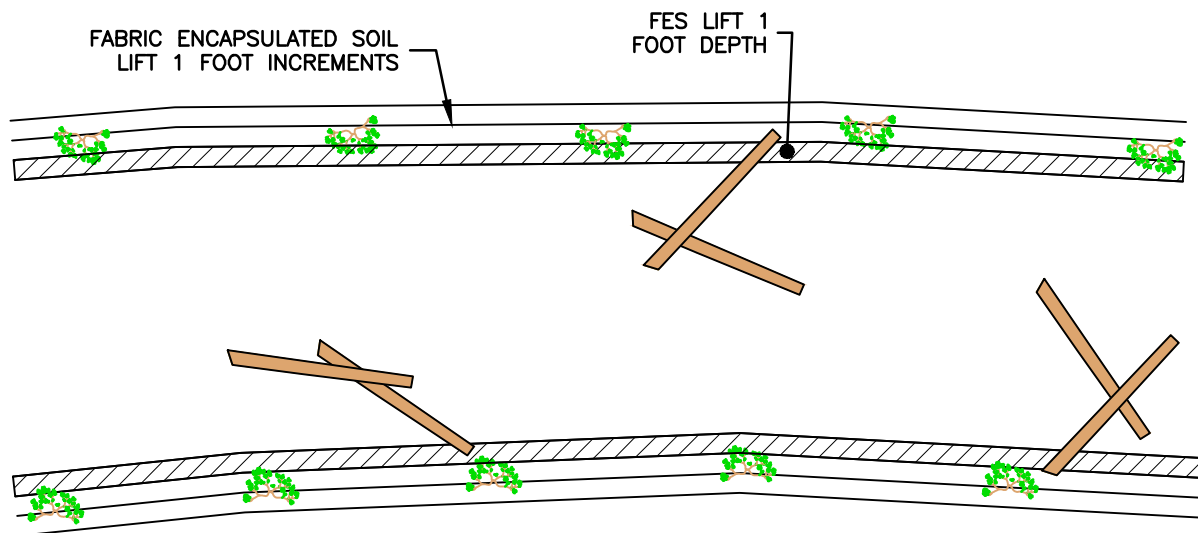

PLAN VIEW:
TYPICAL FABRIC LIFT OPTION
NOT TO SCALE

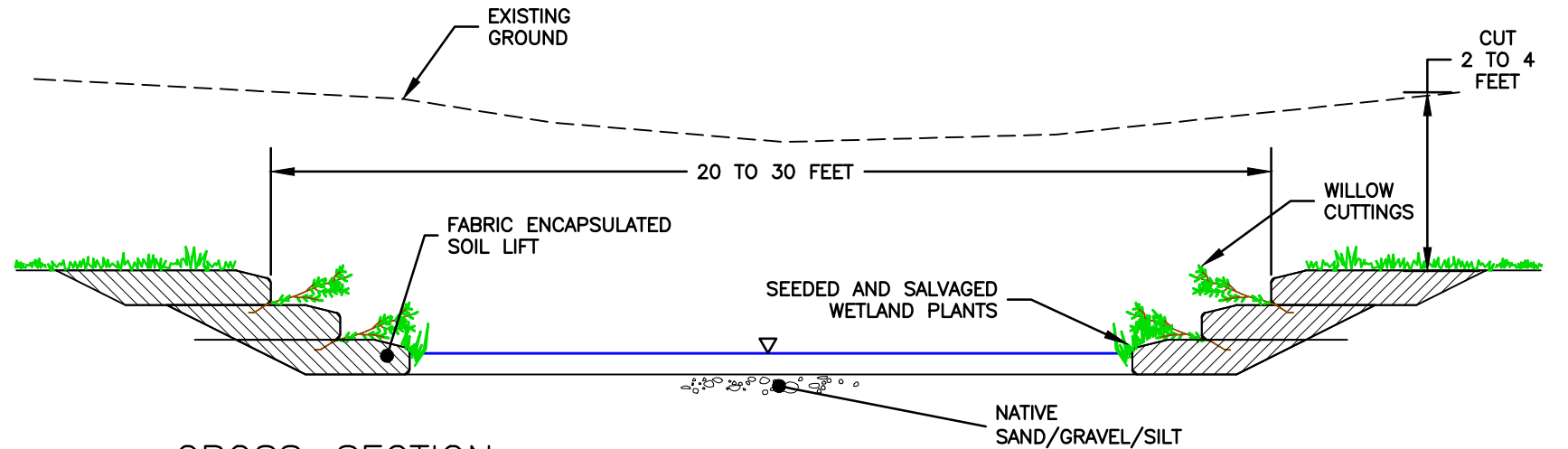

CROSS-SECTION:
NEW CHANNEL CONSTRUCTION – FABRIC LIFT OPTION
NOT TO SCALE

1	DM	1/5/12	
2	RS	1/17/13	PLAN UPDATES BY DOWL HKM
NO.	BY	DATE	REVISION DESCRIPTION

RP	DM, MS	DM
DRAWN	DESIGNED	CHECKED
DM	10/28/09	
APPROVED	DATE	PROJECT

State of Alaska Department of Transportation
and Public Facilities – Haines, Alaska
Haines Highway – MP 3.5 to 25.3



1020 Wasco Street, Suite 1
Hood River, OR 97031
541.386.9003
www.interfluve.com

Conceptual Mitigation Opportunities
Site 513+75

SHEET
7 of 21

Station 530+70

This location is shown on Sheet 8. The stream passes through a 24 inch culvert then flows approximately 200 feet along the toe of the existing road embankment. The left bank is maintained by DOT&PF and has limited riparian vegetation.

The proposed plan is to relocate the stream off the road embankment toe by the creation of approximately 200 feet of new stream. The new stream would initially run perpendicular to the highway, then curve through the forest and join up with the existing stream. Construction would be selectively conducted in order to preserve root structure as a component of the new stream. Supplemental woody debris would be incorporated into the channel. The stream will function as juvenile rearing habitat and provide access to the productive rearing pond on the mountain side of the highway.

A rough planning level construction cost for this option is \$25,000 not including the culvert crossing.

Table 4. Habitat Loss and Gain at Station 530+70

Existing Stream Conditions (length)	Proposed Stream Enhancements (length)
24" culvert; 200' of stream channel is located along highway toe of slope; left bank has limited riparian vegetation.	Create 200' of new stream channel away from highway toe of slope; placement of woody debris, rearing habitat. New Tier 1 fish passage culvert.

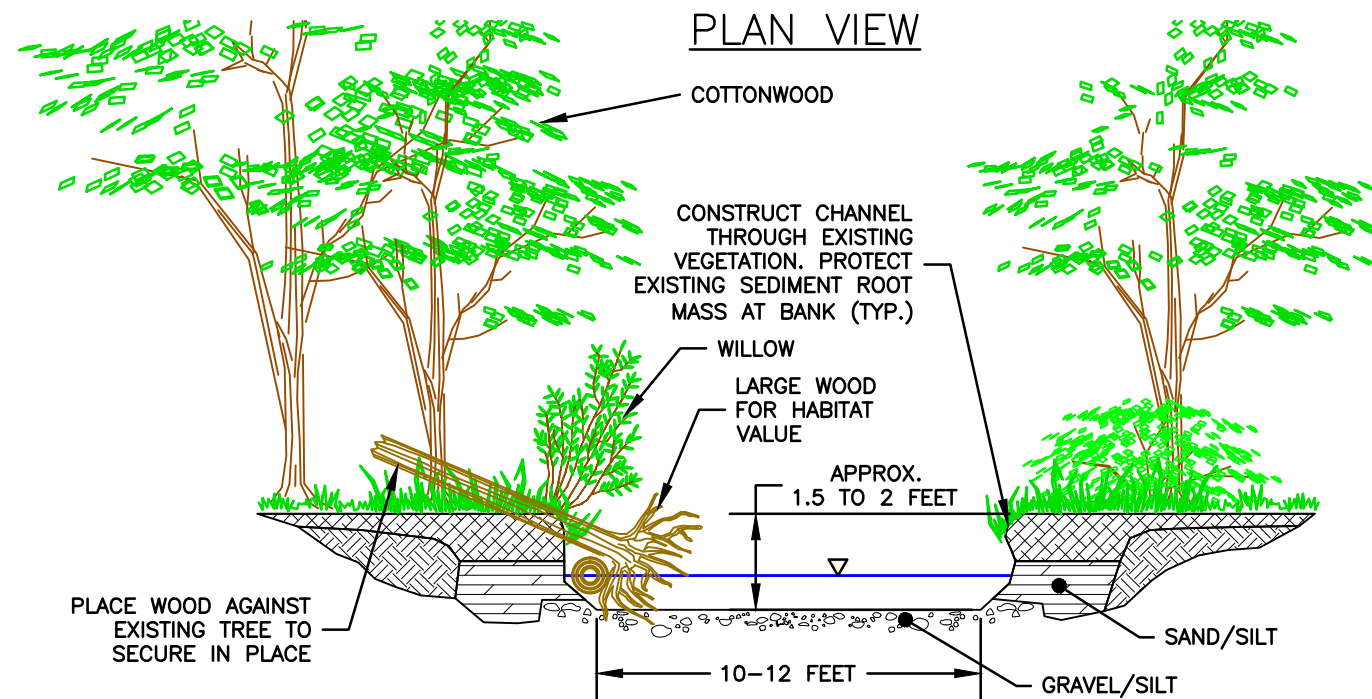
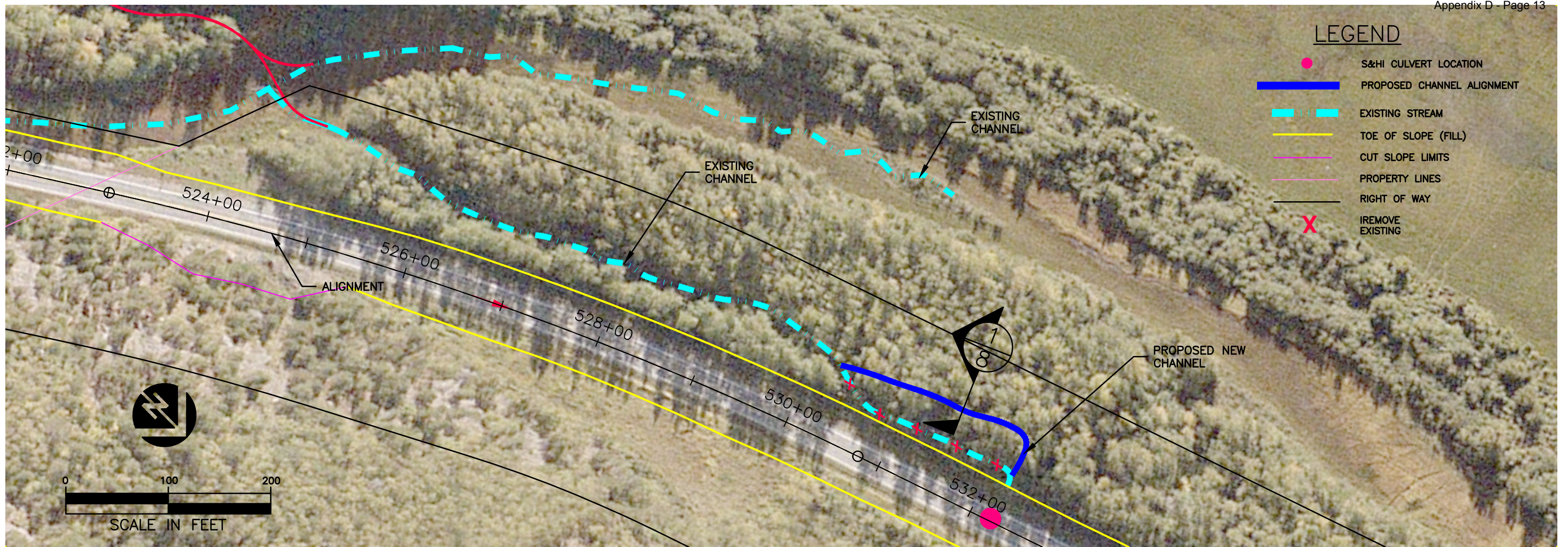

1
8 TYPICAL SECTION: SITE 532+00
NOT TO SCALE

1	DM	1/5/12	
2	RS	1/17/13	PLAN UPDATES BY DOWL HKM
NO.	BY	DATE	REVISION DESCRIPTION

RP	DM, MS	DM
DRAWN	DESIGNED	CHECKED
DM	10/28/09	
APPROVED	DATE	PROJECT

State of Alaska Department of Transportation
and Public Facilities - Haines, Alaska
Haines Highway - MP 3.5 to 25.3



1020 Wasco Street, Suite 1
Hood River, OR 97031
541.386.9003
www.interfluve.com

Conceptual Mitigation Opportunities
Site 532+00

MEMORANDUM

State of Alaska Department of Fish and Game Division of Habitat

TO: Jackie Timothy
Southeast Regional Supervisor

DATE: December 17, 2013

SUBJECT: Haines Highway MP 12
Potential Mitigation Site
Trip Report

FROM: Matthew Kern 
Habitat Biologist

PHONE NO: (907) 465-4182

On October 24, 2013, investigating fish presence in an uncataloged stream near Milepost (MP) 12 of the Haines Highway, Bob Trousil (ADOT&PF) and I identified a new mitigation opportunity for impacts to waters in Phase 1 of the Haines Highway Realignment project (MP 3.5-12).

Upstream of the highway, the stream flows over a barrier waterfall, then through about 200 feet of low gradient, gravel substrate with pool and side channel habitat, before discharging into the Chilkat River through a culvert, fish pipe (FP) 18 (Figure 1). FP 18 has a 1-3 foot perch depending on Chilkat River stage (Figure 2). In addition, near the base of the waterfall, a small distributary channel conveys about 1/10th of the flow branching to the south and diffusing into a wetland area (Figure 3). The wetland is flooded with water when the Chilkat River is high and drains into 11 ½ Mile Creek and then to the Chilkat River through FP 17.



Figure 1. Uncataloged stream looking upstream from highway toward the base of the waterfall (October 25, 2013).



Figure 2. Bob Trousil stands above perched culvert. Waterfall in the background (October 25, 2013).

I set 2 baited minnow traps upstream of the highway and after an overnight soak captured 10 cutthroat trout (40-100 mm), and 5 Dolly Varden char (55-70 mm). In 2011, an ADF&G Habitat field crew captured 3 juvenile coho in this stream with a handnet, and observed others, so it appears there is sporadic anadromous fish use at high flows.

This location could provide ADOT&PF an opportunity to create about 1000 linear feet of new stream by removing existing culvert FP 18, and routing flows of the uncataloged stream through a section of forest into the wetland area, eventually joining 11 ½ Mile Creek and flowing through culvert FP 17 (Figure 4). This proposed enhancement would extend the stream length and increase flow to lower 11 ½ Mile Creek providing additional rearing and possible spawning habitat (Figure 5). 11 ½ Mile Creek, Stream No. 115-32-10250-2032 is cataloged for rearing coho salmon and cutthroat trout.

ADOT&PF currently plans to upgrade culvert FP 17 from two 24 inch CMPs to a Tier 2, 7'3" by 5'3" arch pipe. If this is chosen as mitigation for the project, we will work with ADOT&PF to evaluate the hydraulics of the new stream to ensure that the new culvert will be sized to accommodate additional flows from the uncataloged tributary. Based on observations of the distributary channel, the stream reroute should require minimal gradient modification.

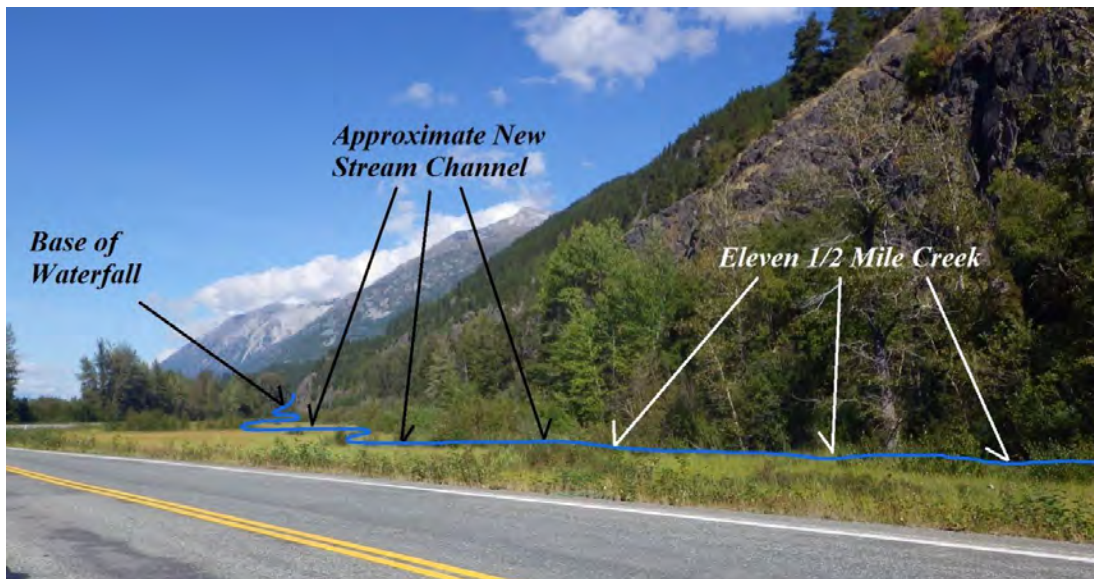

Figure 3. Diagram of potential new stream channel through wetland (Photo: August 29, 2013).

Eleven 1/2 Mile Creek Mitigation Opportunity



Figure 4. Aerial diagram of proposed mitigation channel.



Figure 5. 1 1/2 Mile Creek looking upstream just before it flows under the Haines Highway and joins the Chilkat River (August 29, 2013).

Email cc:

Al Ott, ADF&G Habitat, Fairbanks
ADF&G Habitat Staff, Douglas
Randy Bachman, ADF&G CF, Haines
Rich Chapell, ADF&G SF, Haines
Ryan Scott, ADF&G WC, Juneau
Jim Scholl, ADOT&PF, Juneau
Bob Trousil, ADOT&PF, Juneau
Steve Brockmann, USFWS, Juneau
Hilary Lindh, ADOT&PF, Juneau
Jane Gendron, ADOT&PF, Juneau
Randy Vigil, USACE, Juneau
HCD, NMFS, Juneau

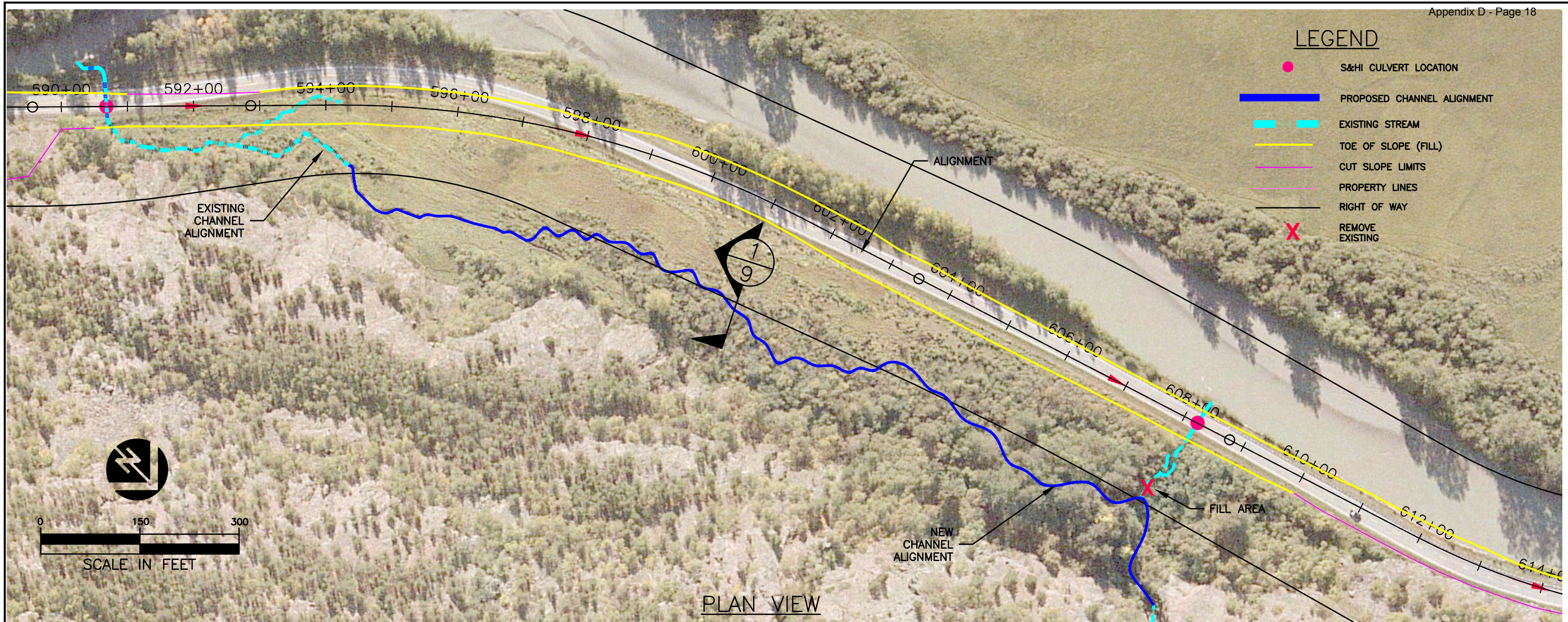

PLAN VIEW

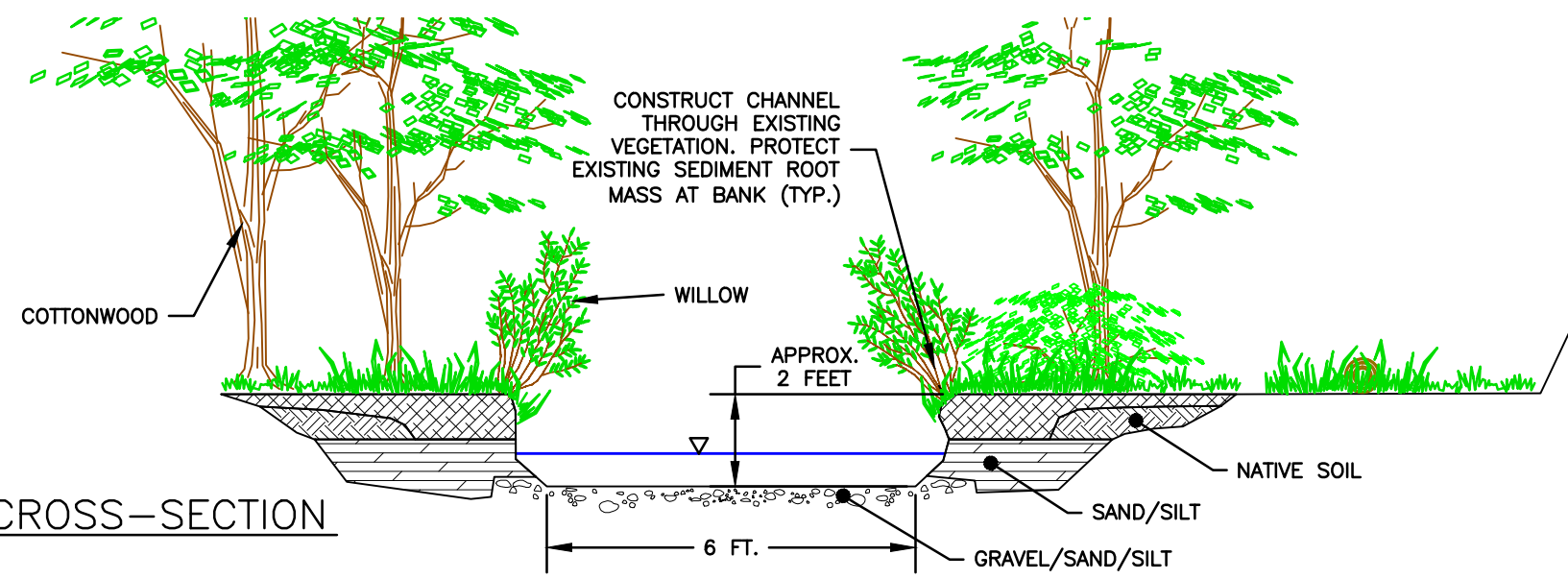

1/9 CONCEPTUAL CROSS-SECTION
NOT TO SCALE

1	RS	1/17/13	PLAN UPDATES BY DOWL HKM
NO.	BY	DATE	REVISION DESCRIPTION

DRAWN	DESIGNED	CHECKED
APPROVED	DATE	PROJECT

State of Alaska Department of Transportation
and Public Facilities - Haines, Alaska
Haines Highway - MP 3.5 to 25.3



Conceptual Mitigation Opportunities
Site 608+00

Station 647+20 and 653+00

This location is shown on Sheets 9 and 10. The stream currently intersects the highway at station 653+00 and then splits, with the primary flow running along the toe of the slope toward the existing culverts at station 647+20. The portion of the current stream alignment that runs along the road upstream of station 677+00 dates from the November 2005 flood event. Prior to that event, the stream turned southward several hundred feet upstream of the highway and did not intersect the road fill until near station 677+00. The recently established section of stream is still actively forming a channel. The stream passes through twin 36 inch culverts then meanders along approximately 650 feet along the toe of the existing road embankment. The left bank of the stream downstream of the culvert is maintained by DOT&PF and has limited riparian vegetation.

The proposed plan is two fold. On the uphill side of the road the plan calls for the creation of a new stream channel that will capture the remaining flows between the culvert at station 647+20 and the old stream channel at 677+00. This channel will be located in the edge of the forest just beyond the toe of the road fill. The channel will be constructed in a manner to preserve as much of the existing riparian habitat and root structures as possible. The stream will feed into the new culverts at station 647+20 and flow into the existing stream channel, which will be modified as is described in the next section.

The main flow of the stream will be directed through a proposed new culvert located at station 653+00. The routing of this stream across the highway at this location provides for the opportunity to construct a significant length of new stream channel. For the first 250-300 feet of this new stream channel two options are presented. Option 1 directs the stream through a mature cottonwood forest and directly across a hump of topography along the distal end of the alluvial fan. This stream section will be of fairly steep gradient, and will not provide much habitat for rearing fish. Option 2 has a shorter steep section (approximately 100 feet) and then a 200 foot section of stream that winds along the toe of the fan and is designed to replicate the form and function of the highly productive stream that presently exists downstream of the existing culvert at station 647+20. This stream is very sinuous, with well vegetated, often undercut banks. It is composed of a series of deep pools separated by glides. Woody debris is present and often provides the structure for the formation of the pools. This alignment exits the ROW for about 150 feet. Fate of high flows within and exiting the marshy area would be determined during design. The potential exists for the new stream to avulse the constructed channel in this area and carve a new channel through the marsh towards the Chilkat River. A conceptual design and proposed location for placement of large woody debris to address this potential is shown in the attached drawings. Sediment deposition at the transition to the lower gradient reach of the new channel is anticipated and details will be addressed during design.

Downstream from the confluence of Option 1 and 2, the stream will continue to meander through the wetland habitat for approximately 500 feet until it intersects with the existing

stream near the culvert outlet at station 647+20. The new channel will utilize existing vegetation for riparian habitat and the meanders will be designed to take advantage of existing root structures to the extent possible. Supplemental woody debris will be incorporated into the channel.

Between station 647+20 and the outlet of the stream at the Chilkat River the existing stream will be left intact unless the road fill directly impinges upon it. In this case, new meander sections of the stream will be created that emulate the impacted sections. These meanders will be designed to mimic the existing form of the stream, and will reconnect undisturbed reaches.

A rough planning level construction cost for this option is approximately \$200,000 total not including the culvert crossing. The cost for the uphill and downhill stream channels is approximately \$45,000 and \$155,000, respectively.

Table 5. Habitat Loss and Gain at Station 647+20 and 653+00

Existing Stream Conditions (length)	Proposed Stream Enhancements (length)
<p>Channel hits highway at 653+00 where it divides, flowing both east and west along the highway toe of slope and crossing the highway at 647+20 (36" CMP) and at 655+50 (24" CMP). Riparian vegetation is limited along highway toe of slope, both upstream of the highway and downstream. The channel downstream of the 655+50 culvert passes through a marsh and exits through a deeply incised channel that resulted from flooding in 2005; the channel is at risk of further down cutting and draining the marsh. The channel downstream of 647+20 is approximately 300', most of which is up against the highway toe of slope.</p>	<p>A new Tier 1 fish passage culvert will be added at 653+00 where the stream currently hits the highway; a new channel upstream of the highway will be created to capture flow along the highway toe of slope that crosses at 647+20; a new Tier 1 fish passage culvert will replace the existing culvert at 647+20. Downstream of the new culvert at 653, two options are considered for creation of a new stream: Option 1 directs stream through mature cottonwood forest for 250-300', fairly steep gradient, not much rearing habitat. Option 2 has a 100' long steep section, then 200' of sinuous, well vegetated channel with undercut banks. Deep pool and glide morphology provide good rearing habitat. Downstream of these two options, another 500' of meandering channel through wetland will also be created, away from the toe of slope.</p>

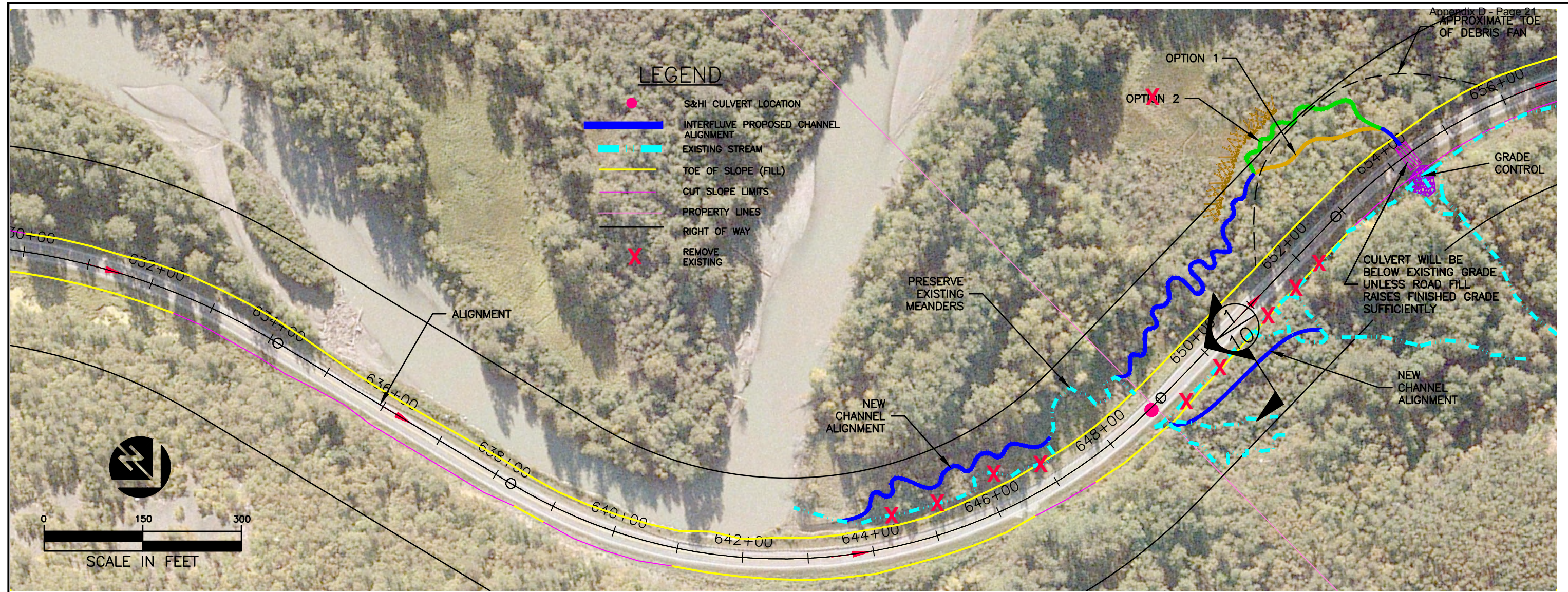

PLAN VIEW

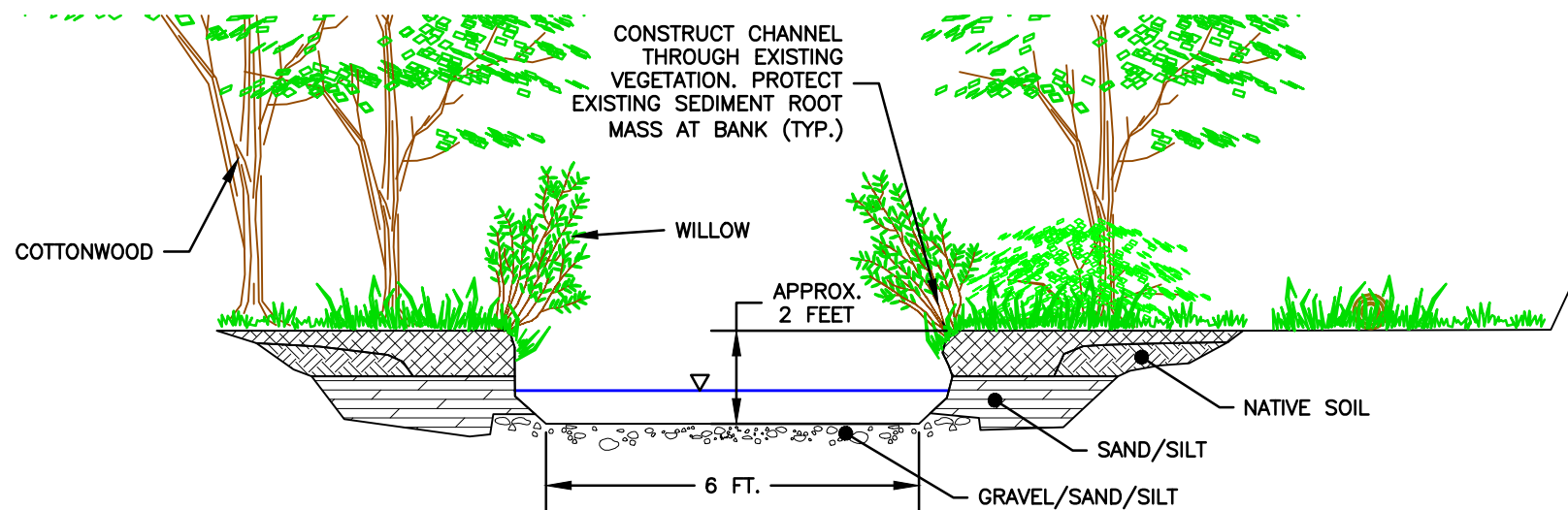

1
10 CONCEPTUAL CROSS-SECTION
NOT TO SCALE

1	DM	1/5/12	
2	RS	1/17/13	PLAN UPDATES BY DOWL HKM
NO.	BY	DATE	REVISION DESCRIPTION

RP	DM, MS	DM
DRAWN	DESIGNED	CHECKED
DM	10/28/09	
APPROVED	DATE	PROJECT

State of Alaska Department of Transportation
and Public Facilities – Haines, Alaska
Haines Highway – MP 3.5 to 25.3



1020 Wasco Street, Suite 1
Hood River, OR 97031
541.386.9003
www.interfluve.com

Conceptual Mitigation Opportunities
Site 647+20

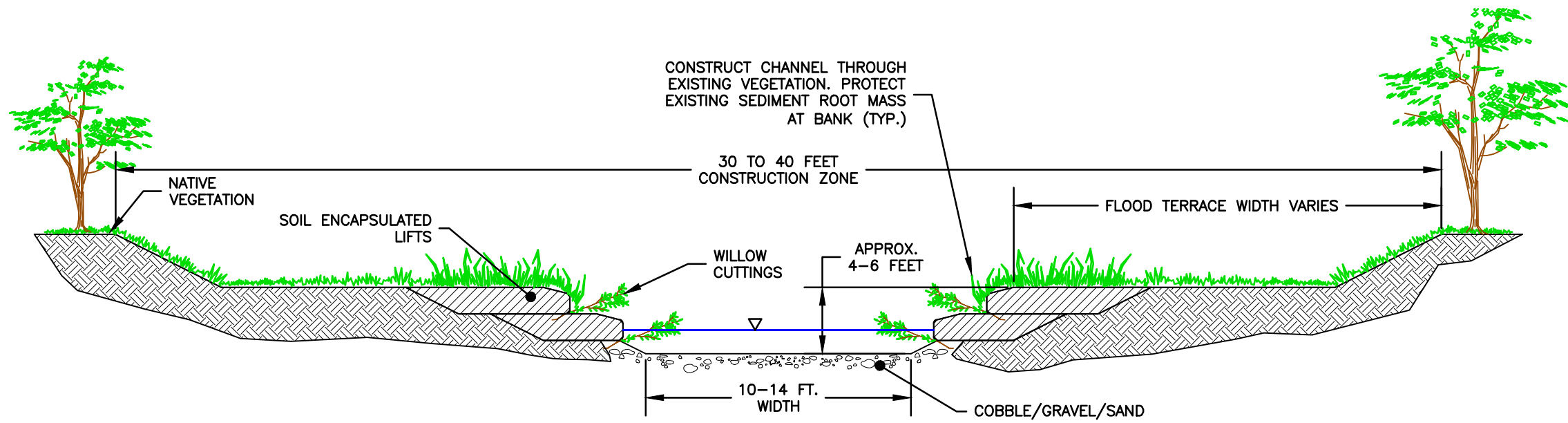

TYPICAL RECONSTRUCTED CHANNEL: OPTION 1
NOT TO SCALE

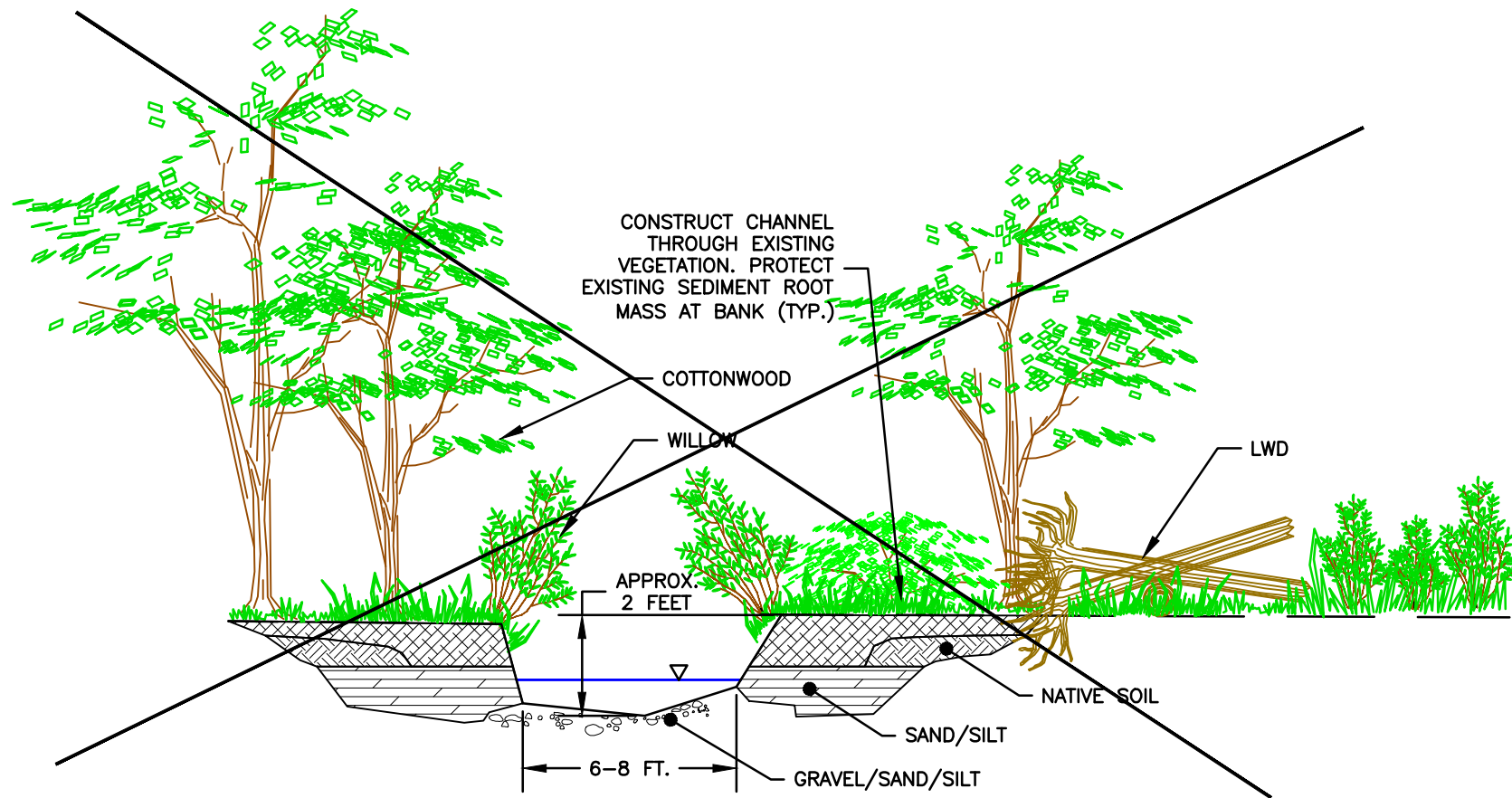

TYPICAL NATIVE SURFACE AND VEGETATION: OPTION 2
NOT TO SCALE

1	DM	1/5/12	
2	RS	1/17/13	PLAN UPDATES BY DOWL HKM
NO.	BY	DATE	REVISION DESCRIPTION

RP	DM, MS	DM
DRAWN	DESIGNED	CHECKED
DM	10/28/09	
APPROVED	DATE	PROJECT

State of Alaska Department of Transportation
and Public Facilities – Haines, Alaska
Haines Highway – MP 3.5 to 25.3



1020 Wasco Street, Suite 1
Hood River, OR 97031
541.386.9003
www.interfluve.com

Conceptual Mitigation Opportunities
Site 647+20

SHEET
11 of 21

Station 736+83

This location is shown on Sheets 11 through 13. The stream passes through a 24 inch culvert then flows approximately 75 feet through a uniform channel. Both banks are maintained by DOT&PF and have limited riparian vegetation.

Due to the raising of the highway grade in this area, the proposed plan is to pick up the flows from the numerous waterfalls between station 733+80 and 740+75 and route this water back on line to the new culvert at station 733+80. The culvert will empty directly into a side channel of the Chilkat River, so there will not be any creation of new habitat downstream of the culvert. The culvert will be skewed to better match stream alignment. The newly created 690 foot stream upstream of the culvert will provide rearing habitat for juvenile fish. It will be excavated in a manner to preserve the existing vegetation to the extent possible, but the routing of the stream is limited due to the steep backslope of the mountainside adjacent to the road fill. The approximate gradient of this stream will be 2%, allowing for the construction of a series of pools and riffles.

A rough planning level construction cost for this option is \$100,000 not including the culvert crossing.

Table 6. Habitat Loss and Gain at Station 736+83

Existing Stream Conditions (length)	Proposed Stream Enhancements (length)
24" culvert; stream flows for 75' with uniform channel and limited riparian vegetation on both banks.	New Tier 2 fish passage culvert at 733+80; creation of 690' channel upstream of the highway to capture flows from numerous waterfalls; riffle-pool morphology to provide rearing habitat.

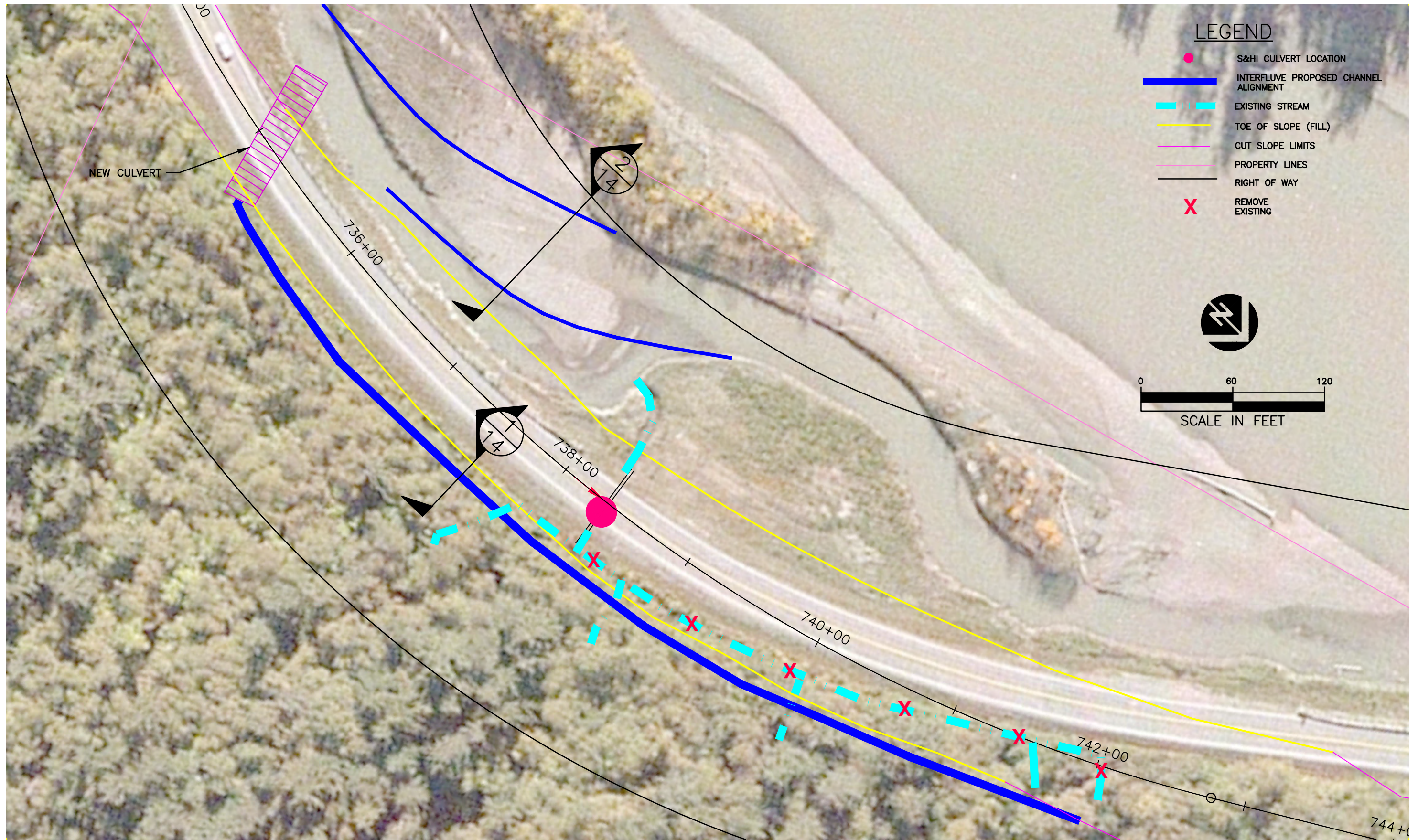

LEGEND

- S&HI CULVERT LOCATION
- INTERFLUVE PROPOSED CHANNEL ALIGNMENT
- - - EXISTING STREAM
- TOE OF SLOPE (FILL)
- CUT SLOPE LIMITS
- PROPERTY LINES
- RIGHT OF WAY
- X REMOVE EXISTING

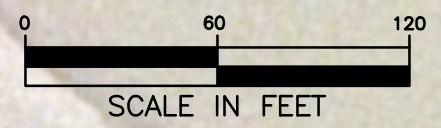

PLAN VIEW

1	DM	1/5/12	
2	RS	1/17/13	PLAN UPDATES BY DOWL HKM
NO.	BY	DATE	REVISION DESCRIPTION

RP	DM, MS	DM
DRAWN	DESIGNED	CHECKED
DM	10/28/09	
APPROVED	DATE	PROJECT

State of Alaska Department of Transportation
and Public Facilities – Haines, Alaska
Haines Highway – MP 3.5 to 25.3



1020 Wasco Street, Suite 1
Hood River, OR 97031
541.366.9003
www.interfluve.com

Conceptual Mitigation Opportunities
Site 736+83

SHEET
12 of 21

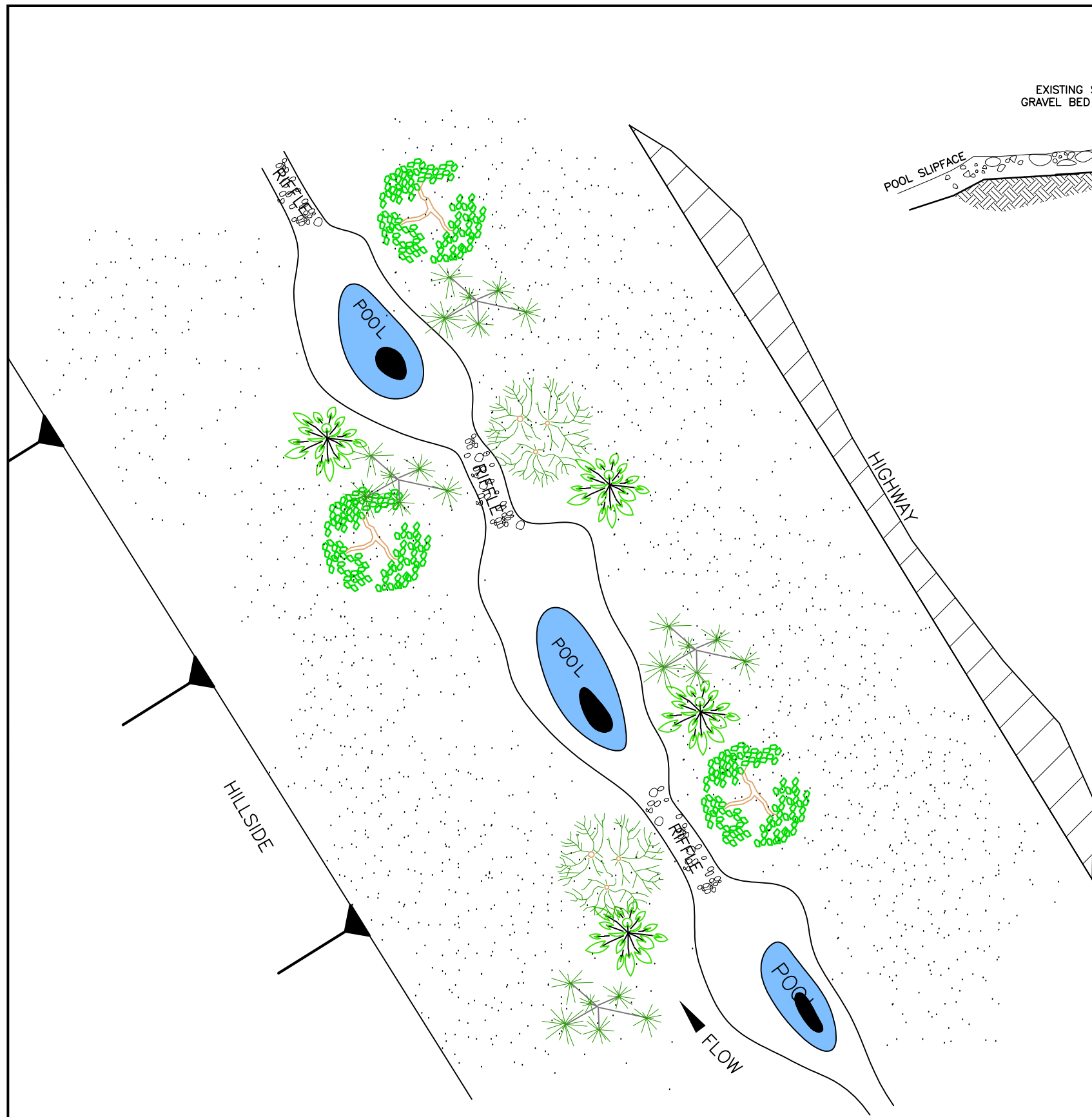

PLAN VIEW POOL-RIFFLE
NOT TO SCALE

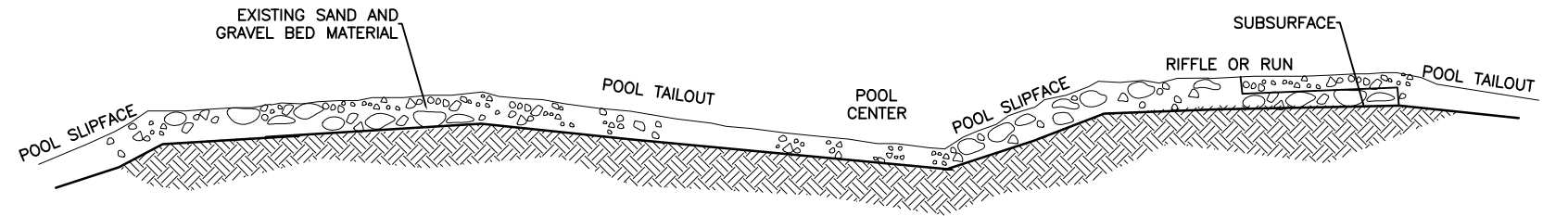

PROFILE VIEW
TYPICAL POOL
NOT TO SCALE

1	DM	1/5/12	
2	RS	1/17/13	PLAN UPDATES BY DOWL HKM
NO.	BY	DATE	REVISION DESCRIPTION

RP	DM, MS	DM
DRAWN	DESIGNED	CHECKED
DM	10/28/09	
APPROVED	DATE	PROJECT

State of Alaska Department of Transportation
and Public Facilities – Haines, Alaska
Haines Highway – MP 3.5 to 25.3



1020 Wasco Street, Suite 1
Hood River, OR 97031
541.386.9003
www.interfluve.com

Conceptual Mitigation Opportunities
Site 736+83

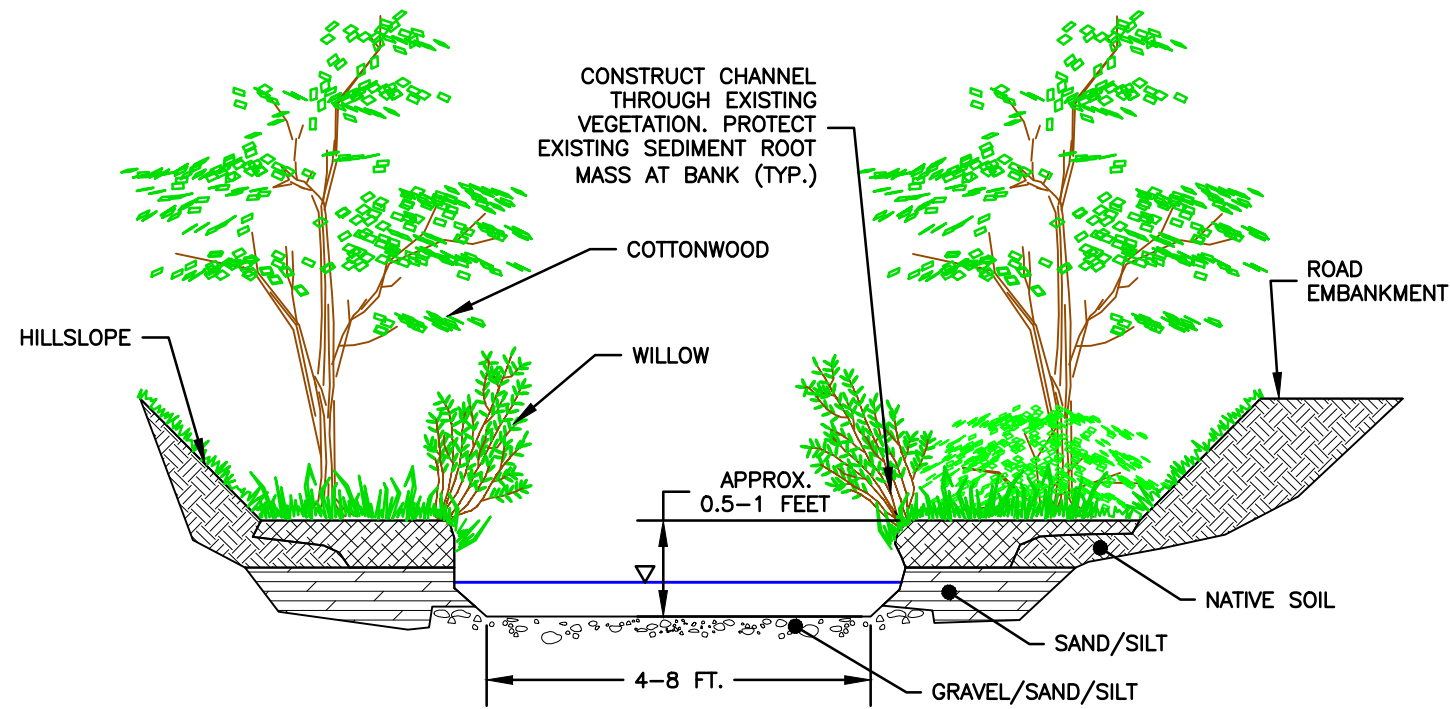

1
14 TYPICAL SECTION: SITE 736+83
NOT TO SCALE

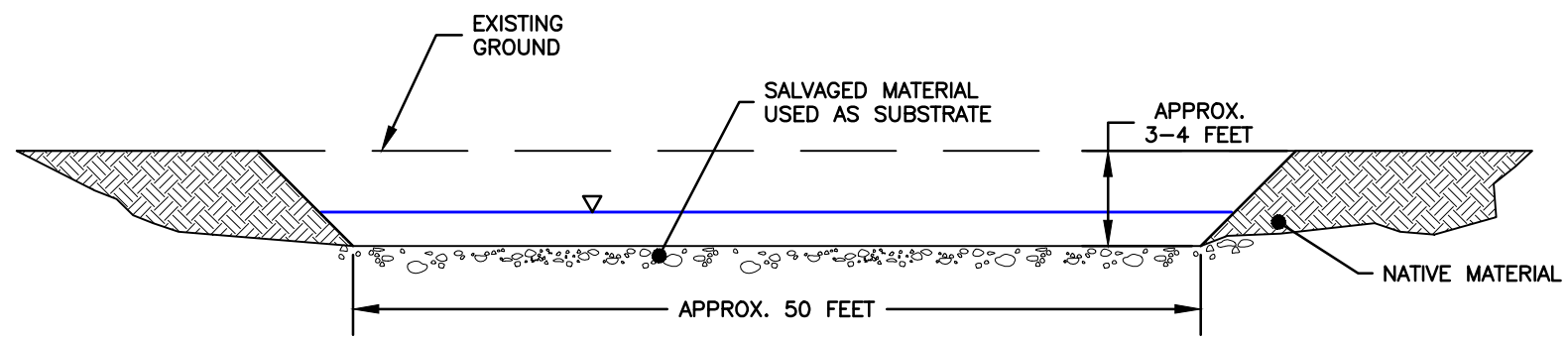

2
14 TYPICAL SECTION: SITE 736+83
NOT TO SCALE

1	DM	1/5/12	
2	RS	1/17/13	PLAN UPDATES BY DOWL HKM
NO.	BY	DATE	REVISION DESCRIPTION

RP	DM, MS	DM
DRAWN	DESIGNED	CHECKED
DM	10/28/09	
APPROVED	DATE	PROJECT

State of Alaska Department of Transportation
and Public Facilities – Haines, Alaska
Haines Highway – MP 3.5 to 25.3



1020 Wasco Street, Suite 1
Hood River, OR 97031
541.386.9003
www.interfluve.com

Conceptual Mitigation Opportunities
Site 736+83

SHEET

14 of 21

Station 733+70 to 736+70 Chilkat River Side Channel

This location is shown on Sheets 11 and 13. The new highway alignment in this area results in the filling of a portion of a side channel of the Chilkat River that was identified in the Stream and Habitat Inventory as productive coho and chum spawning habitat. The existing channel runs along the rip rap toe of the existing highway fill.

It is proposed that the adjacent gravel bar be excavated to create a new side channel for the river that matches into the upstream and downstream elevations of the existing side channel. The channel width is based on the width of the existing channel. No material will be imported or placed to form a spawning gravel subgrade. The existing river gravels in the channel will be left in place. The banks of the new channel will be sloped back at a 1:1 slope, and will not be vegetated. The area of the new channel will be entirely flooded during high water events, and revegetation, if it occurs, will be achieved naturally on the areas of the river bar that remain stable.

A rough planning level construction cost for this option is \$50,000.

Table 7. Habitat Loss and Gain at Station 733+70 to 736+70

Existing Stream Conditions	Proposed Stream Enhancements
Productive coho and chum spawning channel along toe of rip rap slope. Embankment fills to impact channel.	A new spawning channel will be excavated from adjacent gravel bar to match upstream and downstream elevations and widths. Existing river gravels will be left in place for spawning.

Station 865+88

This location is shown on Sheets 14 and 15. The stream passes through a 73 inch by 55 inch culvert and flows about 100 feet before discharging into a side channel of the Chilkat River. This site has numerous springs along the toe of the hill slope. Currently these springs are collected in a ditch and routed to a weir and screened inlet to supply a complex of stainless steel salmon egg incubation boxes operated by Northern Southeast Regional Aquaculture Association (NSRAA). Although a stream restoration plan that involved the removal of the boxes and the establishment of an extended stream system utilizing the available flow was considered, it was decided that the incubation boxes would remain in place.

The proposed plan is to relocate the new culvert ahead on line to station 869+75, and to construct a new length of stream channel from the culvert outlet through the forested terrace, and joining with the existing stream outlet. This stream will be approximately 500 feet in length. The stream will be four to six feet in width, and the banks will be either formed by the existing material, utilizing the inherent stability of the existing root mass, or created using fabric wrapped soil lifts. The existing vegetation along the new stream corridor will be protected to the extent possible in order to provide a healthy riparian habitat. Willows will be planted as needed to provide additional vegetation and bank stability. This stream will function primarily as rearing habitat, but will also provide a corridor for the return, and possible harvesting for eggs, of chum salmon to the incubation box site.

Additionally, the plan proposes the enhancement of the existing pool habitat along the east side of the road (mountain side) with woody debris structures. These structures will provide additional cover for rearing fish. The perimeter of the pool will be planted with willows to provide a riparian canopy. The beaver pond that is currently blocked and not available to rearing fish will also be opened and connected to the flowing stream. A short stream section just downstream of the incubation boxes will be constructed to route the stream away from the toe of the new road fill.

A rough planning level construction cost for this option is \$100,000 not including the culvert crossing.

Table 8. Habitat Loss and Gain at Station 865+88

Existing Stream Conditions	Proposed Stream Enhancements
73" x 55" culvert; stream flows 100' downstream of highway to river. Upstream of the culvert there is an existing pond complex fed by numerous springs which are routed through a weir and screened inlet that supplies water to a series of stainless steel salmon egg incubation boxes.	The old culvert will be abandoned and a new Tier 1 fish passage culvert installed at 869+75. The existing pool habitat on the upstream side of the highway will be enhanced by installing woody debris structures and planting the perimeter of the pool with willows.

	<p>An existing beaver pond will be unblocked to allow entry by rearing fish. A short section of stream downstream of the incubation boxes will be constructed to route the water away from the highway toe of slope. Downstream of the culvert, a new 500' stream channel will be created through forested terrace; additional vegetation planting will add to existing to ensure good riparian on both banks for rearing habitat.</p>
--	--



ALIGNMENT

LEGEND

- S&HI CULVERT LOCATION
- INTERFLUVE PROPOSED CHANNEL ALIGNMENT
- - - EXISTING STREAM
- TOE OF SLOPE (FILL)
- CUT SLOPE LIMITS
- PROPERTY LINES
- RIGHT OF WAY
- X REMOVE EXISTING

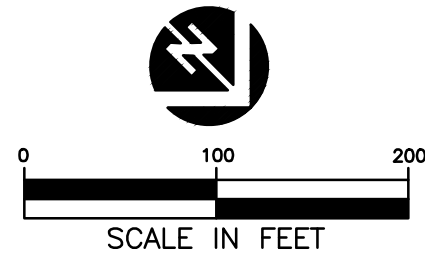
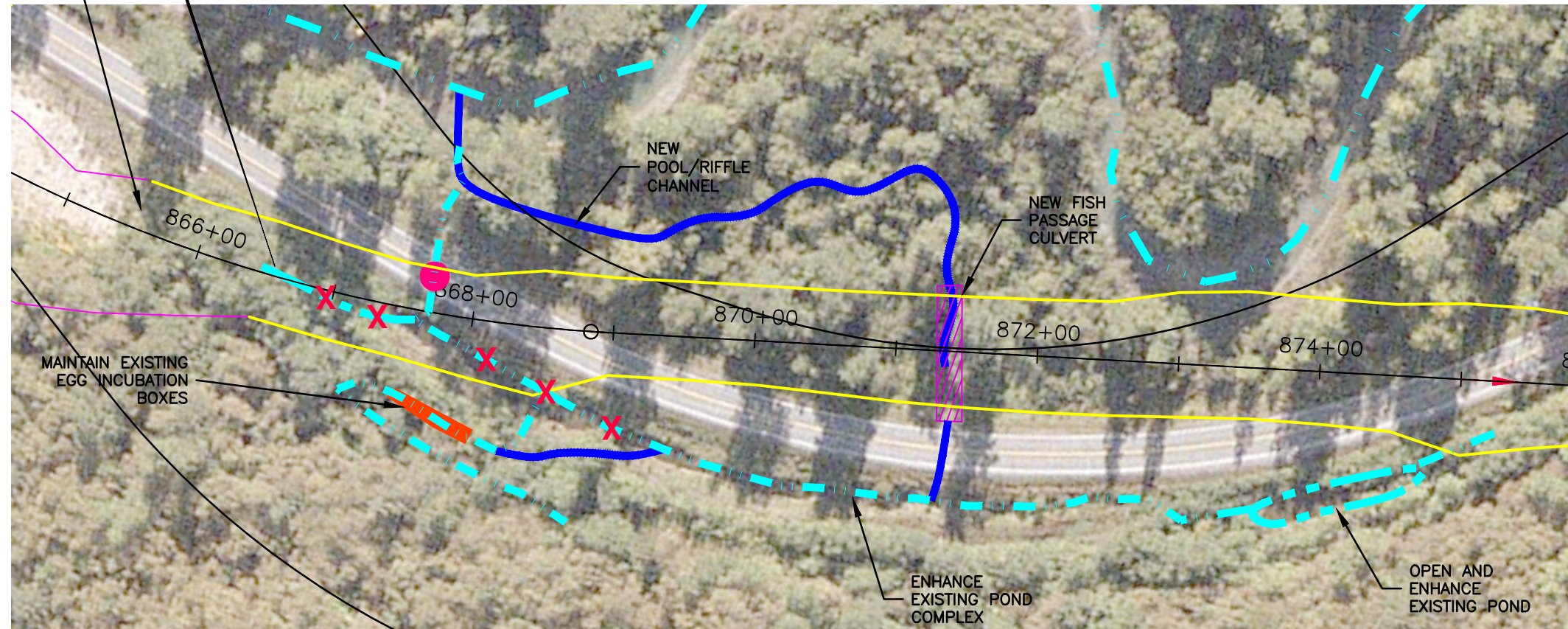

PLAN VIEW – STREAM CREATION TO MAINTAIN EXISTING NSRAA EGG INCUBATION BOXES

1	DM	1/5/12	
2	RS	1/17/13	PLAN UPDATES BY DOWL HKM
NO.	BY	DATE	REVISION DESCRIPTION

RP	DM, MS	DM
DRAWN	DESIGNED	CHECKED
DM	10/28/09	
APPROVED	DATE	PROJECT

State of Alaska Department of Transportation
and Public Facilities – Haines, Alaska
Haines Highway – MP 3.5 to 25.3



1020 Wasco Street, Suite 1
Hood River, OR 97031
541.386.9003
www.interfluve.com

Conceptual Mitigation Opportunities
Site 869+00

SHEET
15 of 21

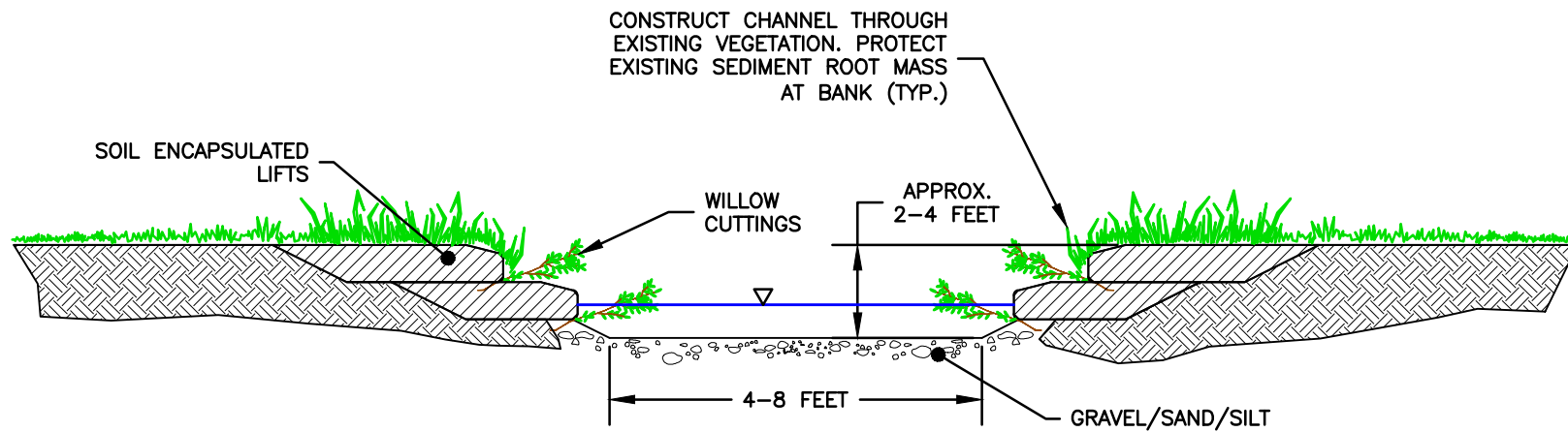

TYPICAL NEW POOL/RIFFLE CHANNEL
NOT TO SCALE

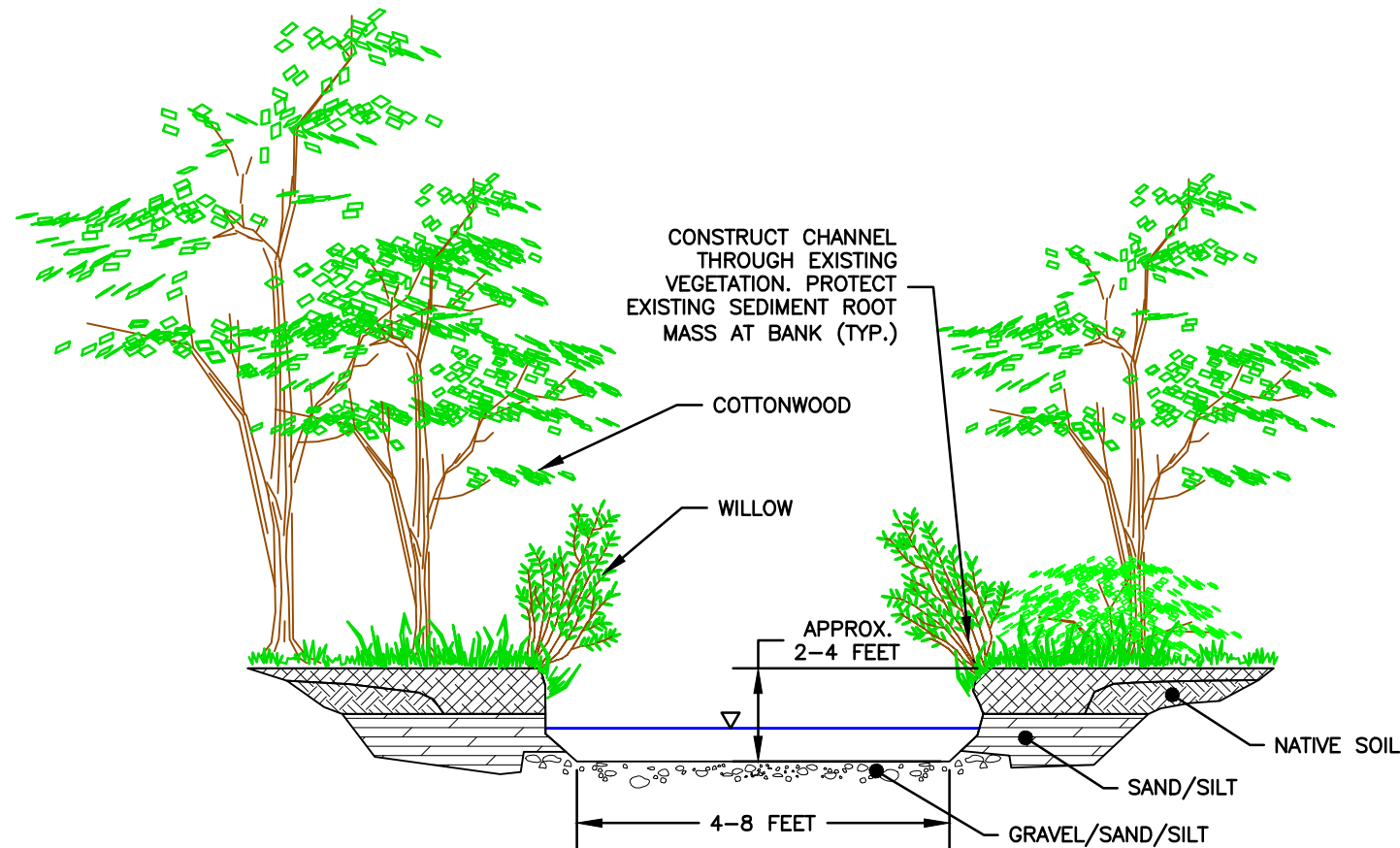

TYPICAL NATIVE SURFACE AND VEGETATION: NEW POOL/RIFFLE CHANNEL
NOT TO SCALE

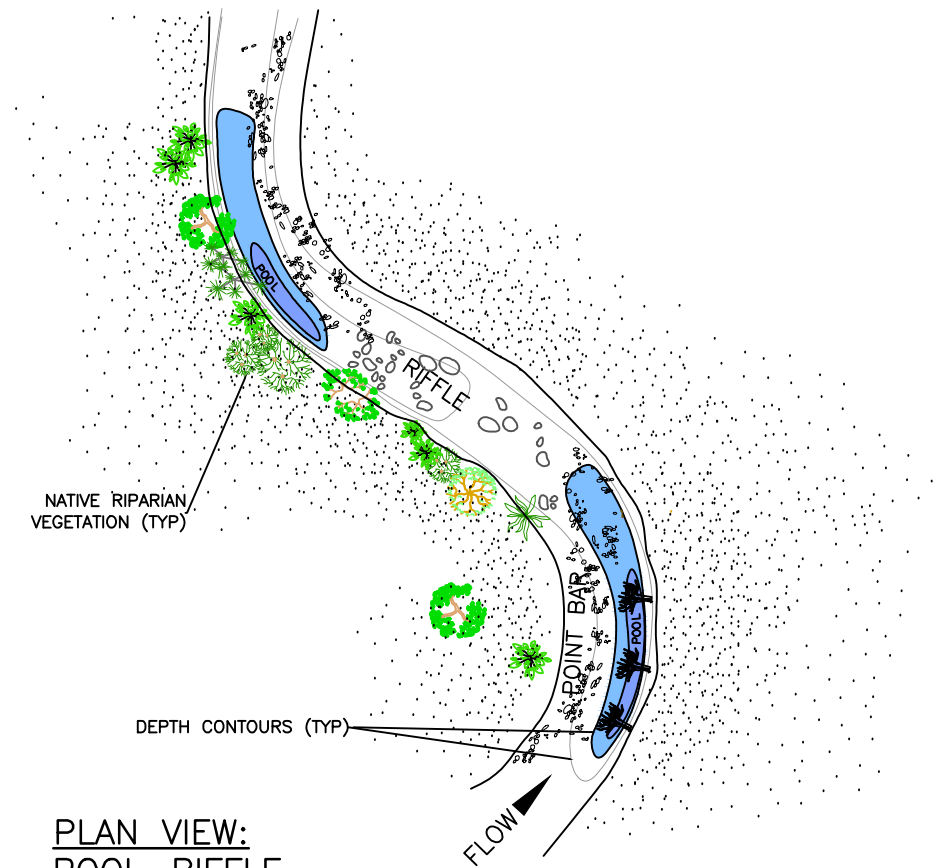

**PLAN VIEW:
POOL-RIFFLE**
NOT TO SCALE

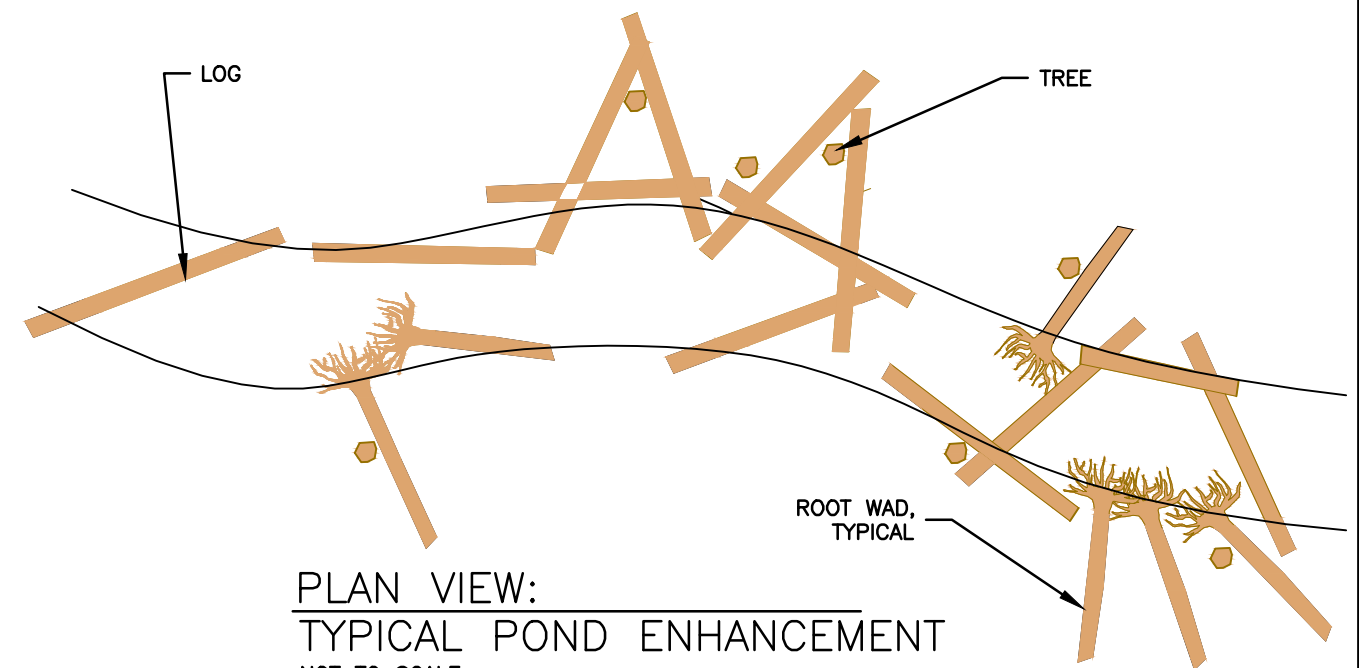

**PLAN VIEW:
TYPICAL POND ENHANCEMENT**
NOT TO SCALE

1	DM	1/5/12	
2	RS	1/17/13	PLAN UPDATES BY DOWL HKM
NO.	BY	DATE	REVISION DESCRIPTION

RP	DM, MS	DM
DRAWN	DESIGNED	CHECKED
DM	10/28/09	
APPROVED	DATE	PROJECT

State of Alaska Department of Transportation
and Public Facilities – Haines, Alaska
Haines Highway – MP 3.5 to 25.3



1020 Wasco Street, Suite 1
Hood River, OR 97031
541.386.9003
www.interfluve.com

Conceptual Mitigation Opportunities
Site 869+00

SHEET

16 of 21

Station 887+60

This location is shown on Sheets 16 and 17. The stream, locally known as Horse Farm Creek, passes through twin 36 inch culverts then flows approximately 800 feet along the toe of the maintained by DOT&PF and has limited riparian vegetation.

The proposed final highway alignment crosses this stream very near its confluence with Eighteen Mile Slough. This crossing will involve the placement of a large culvert, and no mitigation opportunities exist in the immediate area of the culvert. However, there are opportunities to enhance the sections of the stream that flow along the toe of the current highway, and removal of the twin 36 inch culverts and re-establishment of an open channel provides additional habitat creation. The proposed plan is to introduce woody debris into two sections of the existing stream, in the locations shown on the accompanying drawings. In addition to directly providing cover and velocity refuge, the introduction of large woody debris into the stream will result in the localized scouring of pools, cause an increase in the amount of undercut bank available for cover, and increase the meander in the straighter section of the stream. The creation of new pool and riffle habitat will increase both spawning and rearing habitat. The removal of the culverts and the construction of a new stream channel and associated floodplain will provide salmon spawning habitat and open access for fish to the upper reaches of the stream system. The existing highway embankment will be partially excavated along a portion of the stream to create a hydrologically connected flood terrace vegetated with native riparian vegetation. Part of the highway embankment along the hillside shoulder will remain in place to provide a corridor for the utilities present in the old gas pipeline.

A rough planning level construction cost for this option is \$75,000.

Table 9. Habitat Loss and Gain at Station 887+60

Existing Stream Conditions	Proposed Stream Enhancements
Two 36" culverts at 896+00 on old alignment; downstream flow for 800' along toe of slope; left bank has limited riparian vegetation.	Remove culverts at 896+00 and create new stream channel across abandoned highway alignment. Install new Tier 1 fish passage culvert at 887+60. Introduce woody debris to existing stream channel to encourage creation of pools and riffles and improve spawning and rearing habitat. A portion of the existing road embankment will be excavated along the stream to create a hydrologically connected flood terrace vegetated with native riparian species.

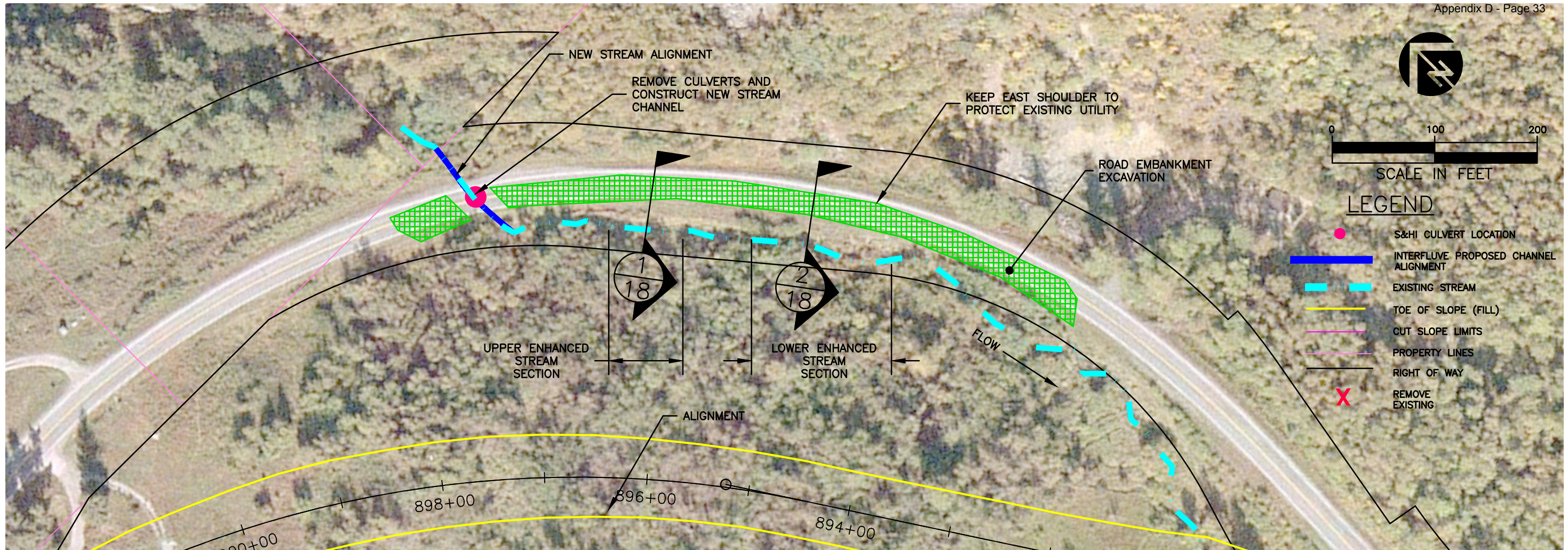

PLAN VIEW – STREAM ENHANCEMENT

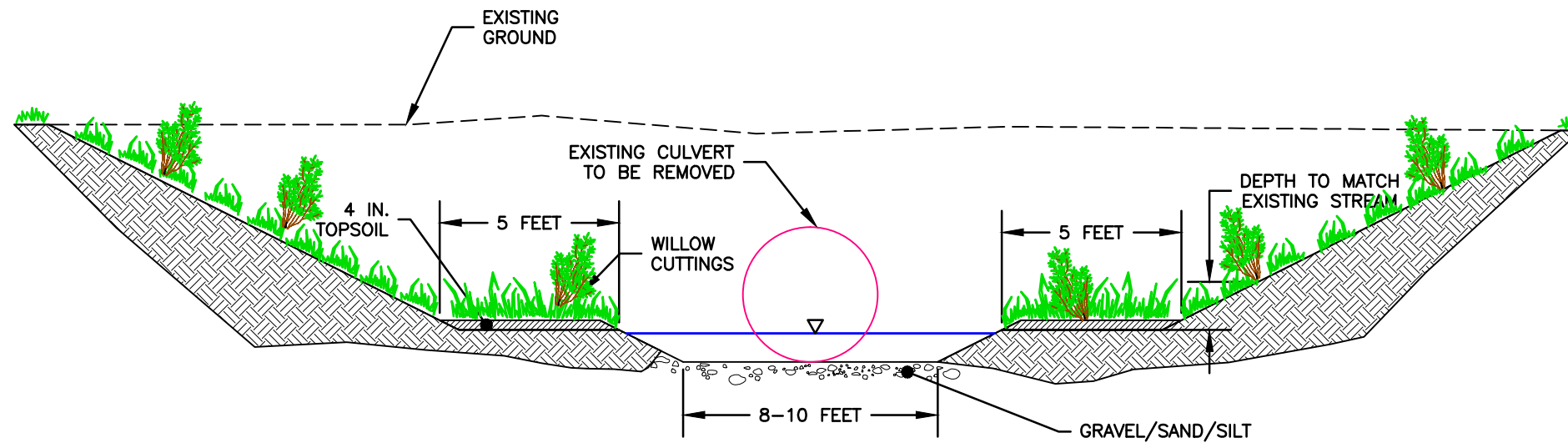

TYPICAL CULVERT REMOVAL
NOT TO SCALE

1	DM	1/5/12	
2	RS	1/17/13	PLAN UPDATES BY DOWL HKM
NO.	BY	DATE	REVISION DESCRIPTION

RP	DM, MS	DM
DRAWN	DESIGNED	CHECKED
DM	10/28/09	
APPROVED	DATE	PROJECT

State of Alaska Department of Transportation
and Public Facilities – Haines, Alaska
Haines Highway – MP 3.5 to 25.3



1020 Wasco Street, Suite 1
Hood River, OR 97031
541.386.9003
www.interfluve.com

Conceptual Mitigation Opportunities
Site 895+00

SHEET

17 of 21

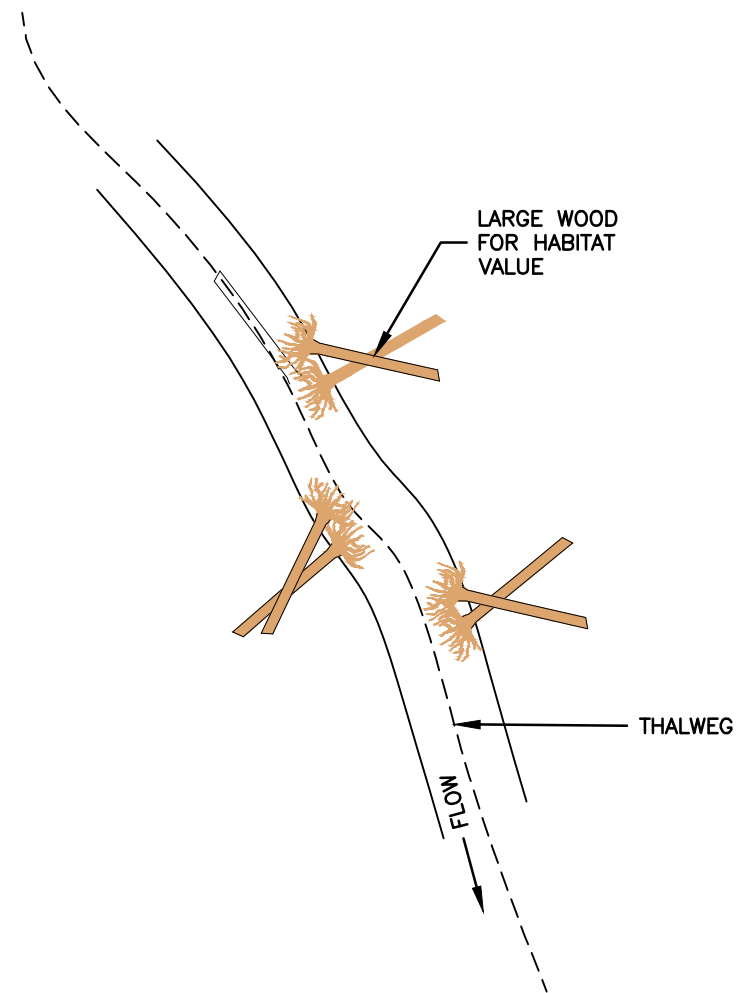

PLAN VIEW: UPPER STREAM
ENHANCEMENT SITE
NOT TO SCALE

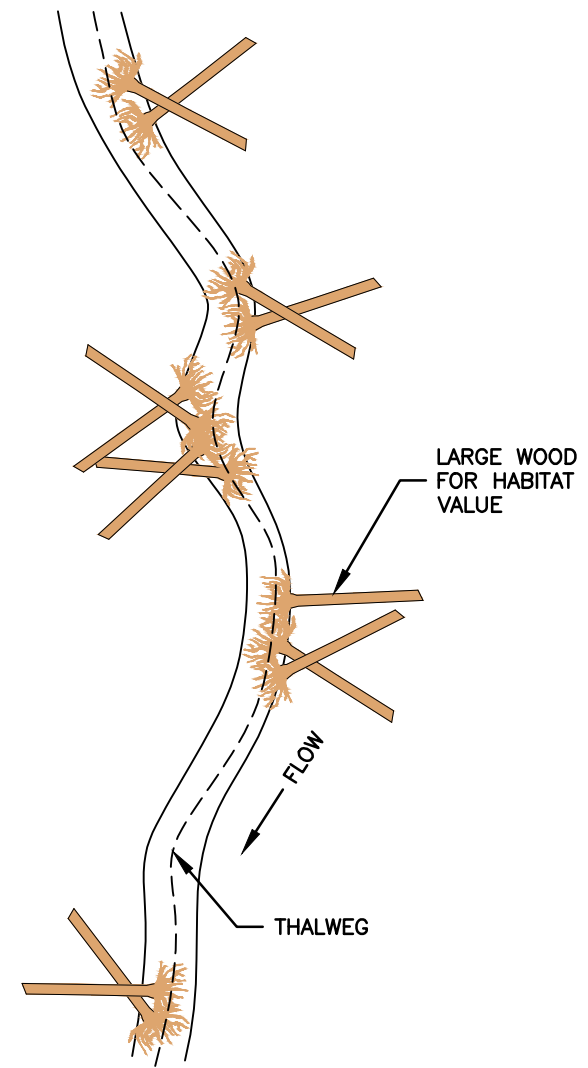

PLAN VIEW: LOWER STREAM
ENHANCEMENT SITE
NOT TO SCALE

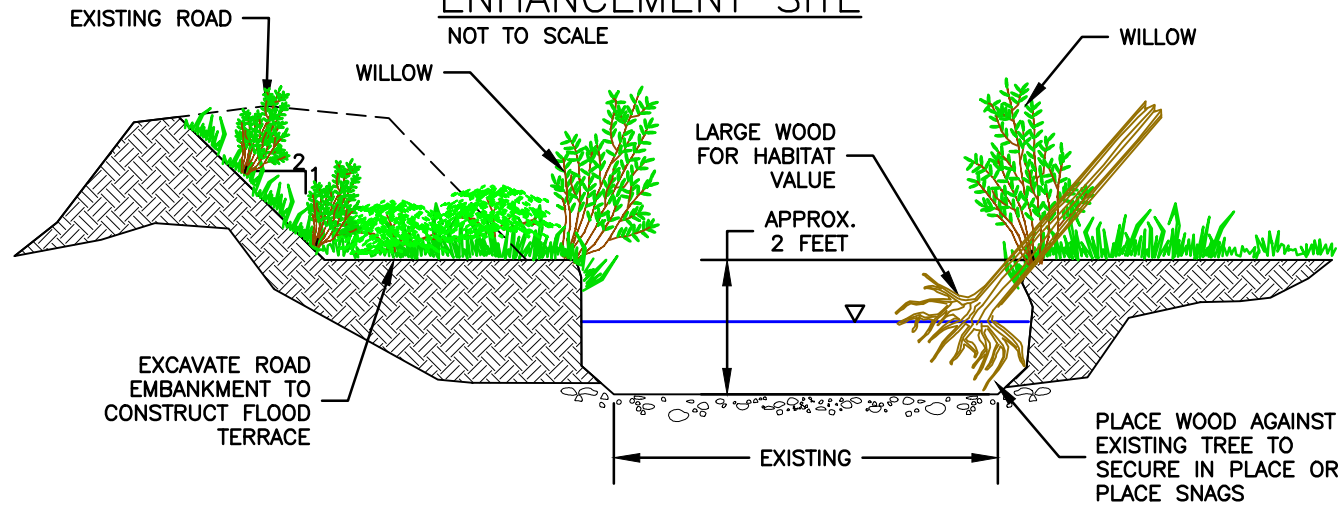

1
18 TYPICAL SECTION: UPPER STREAM
ENHANCEMENT SITE
NOT TO SCALE

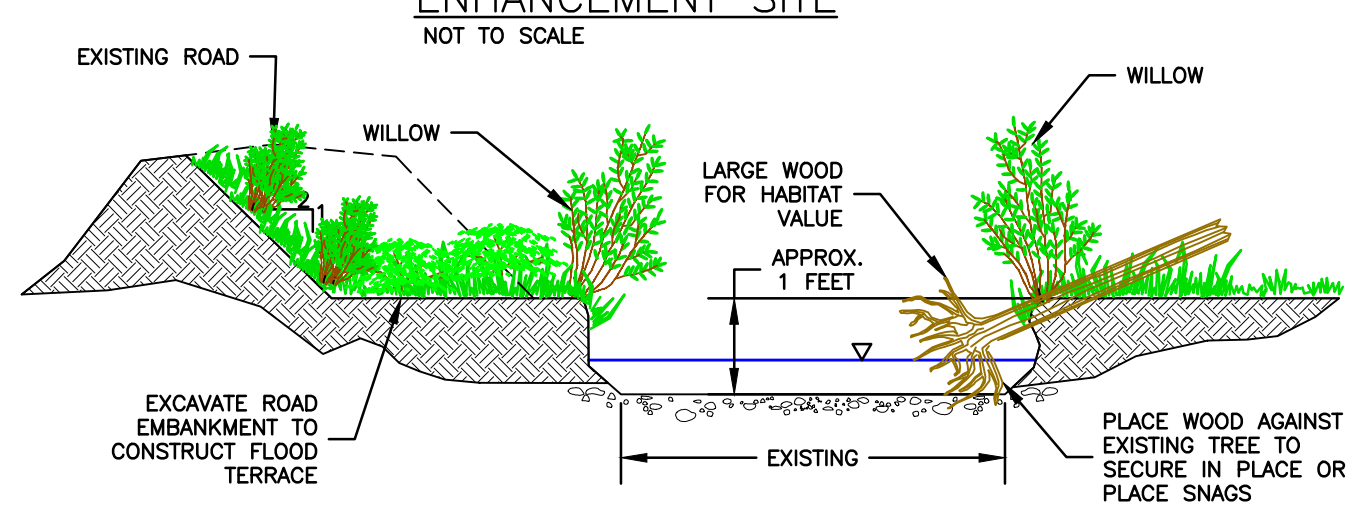

2
18 TYPICAL SECTION: LOWER STREAM
ENHANCEMENT SITE
NOT TO SCALE

1	DM	1/5/12	
2	RS	1/17/13	PLAN UPDATES BY DOWL HKM
NO.	BY	DATE	REVISION DESCRIPTION

RP	DM, MS	DM
DRAWN	DESIGNED	CHECKED
DM	10/28/09	
APPROVED	DATE	PROJECT

State of Alaska Department of Transportation
and Public Facilities – Haines, Alaska
Haines Highway – MP 3.5 to 25.3



1020 Wasco Street, Suite 1
Hood River, OR 97031
541.386.9003
www.interfluve.com

Conceptual Mitigation Opportunities
Site 895+00

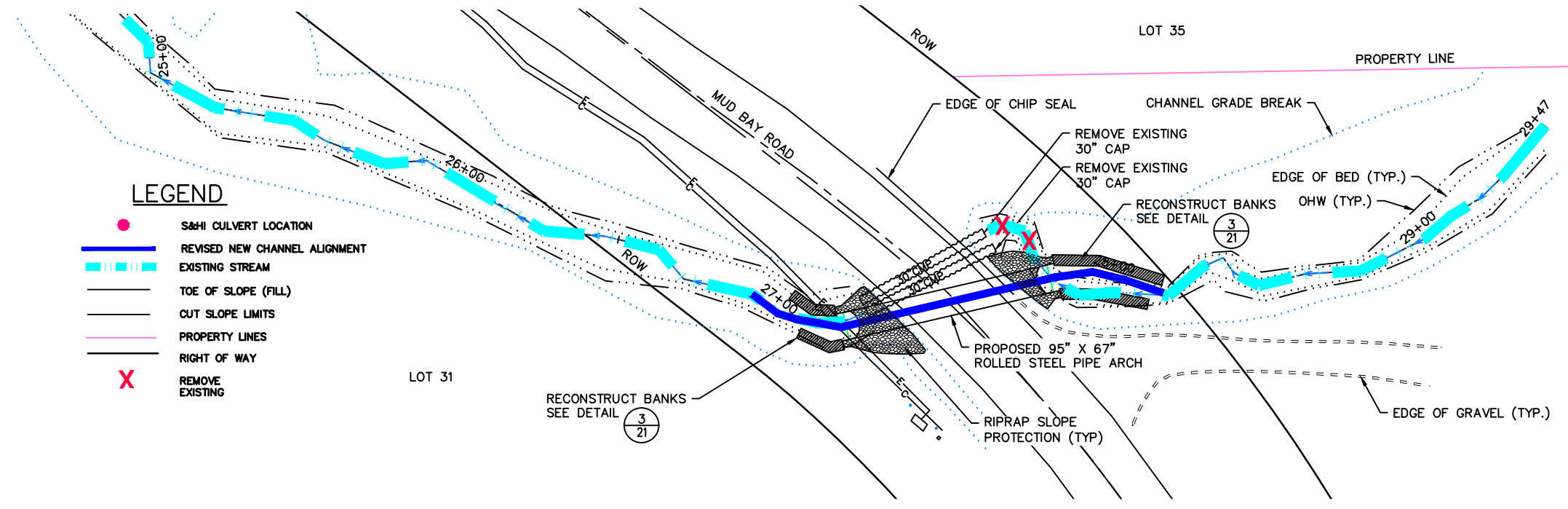

- LEGEND**
- S&H I CULVERT LOCATION
 - REVISED NEW CHANNEL ALIGNMENT
 - EXISTING STREAM
 - TOE OF SLOPE (FILL)
 - CUT SLOPE LIMITS
 - PROPERTY LINES
 - RIGHT OF WAY
 - X REMOVE EXISTING

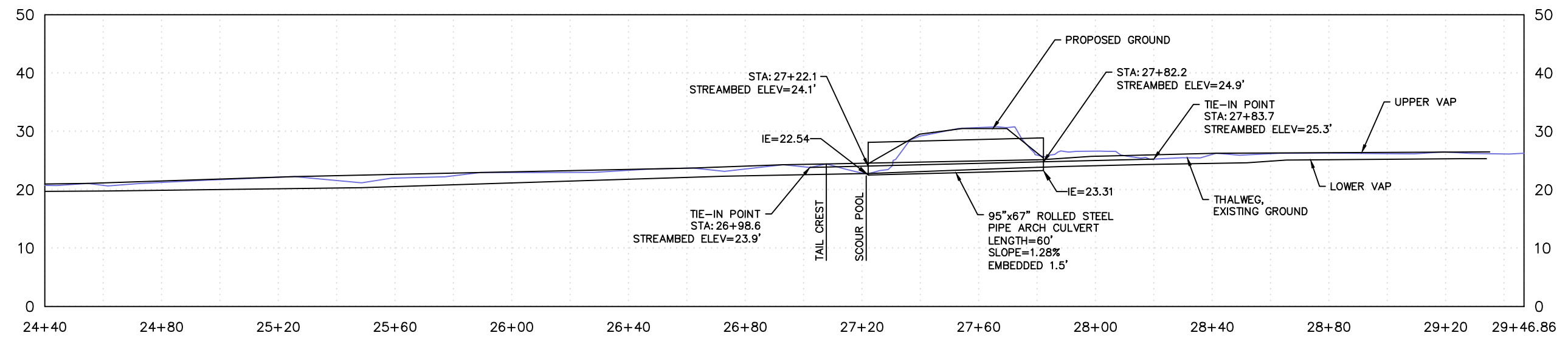
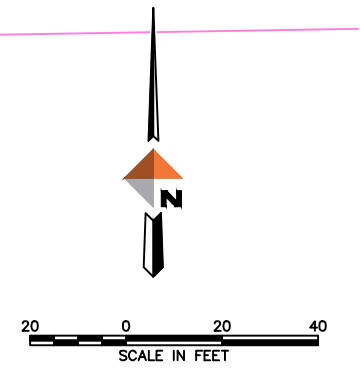

1	RS	1/17/13	PLAN UPDATES BY DOWL HKM
NO.	BY	DATE	REVISION DESCRIPTION

DRAWN	DESIGNED	CHECKED
APPROVED	DATE	PROJECT

State of Alaska Department of Transportation
and Public Facilities – Haines, Alaska
Haines Highway – MP 3.5 to 25.3



Cannery Creek Fish Passage
Improvements Project
Mud Bay Road

SHEET
20 of 21

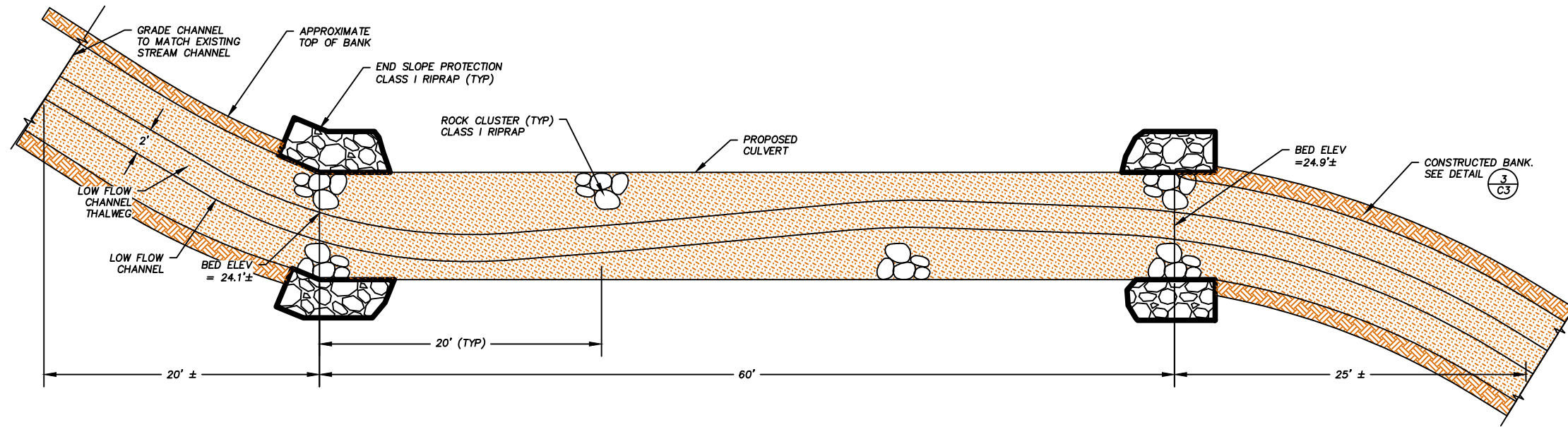

1
21
CONSTRUCTED CHANNEL DETAIL
NTS

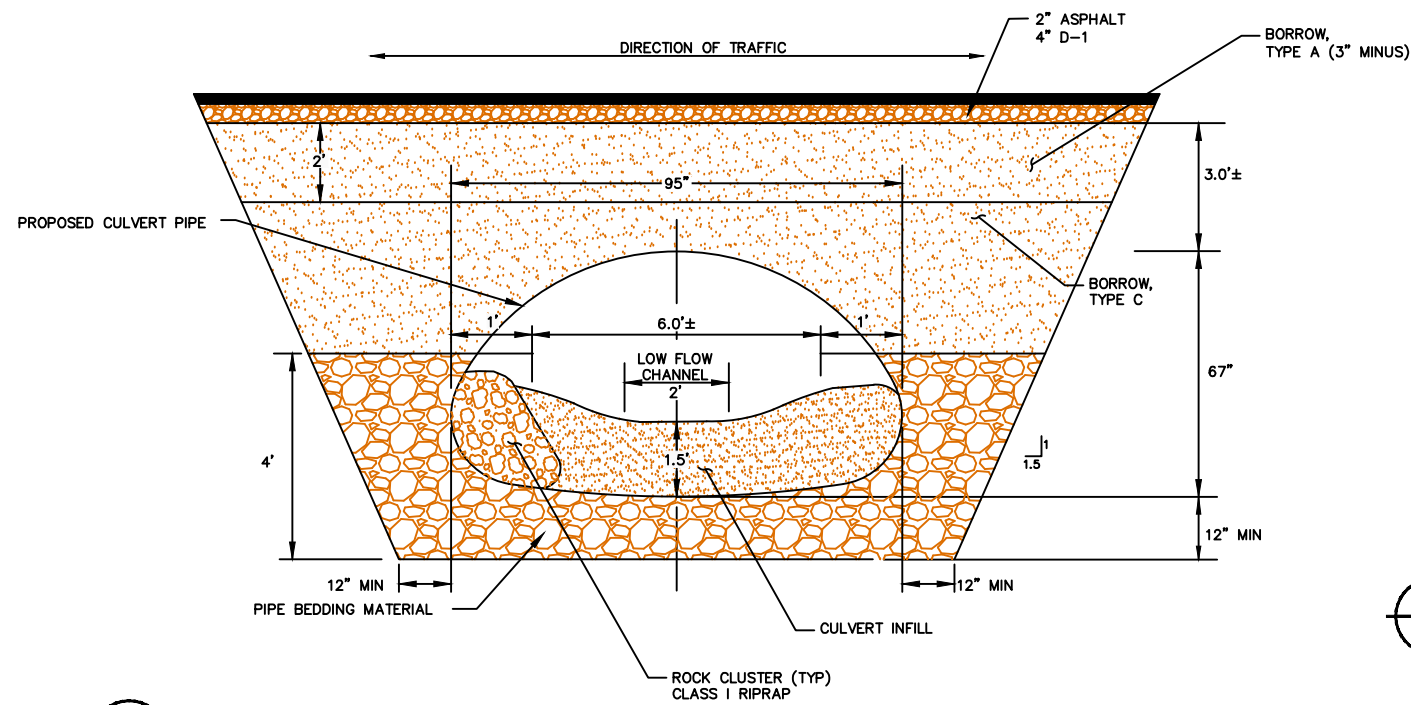

2
21
TYPICAL CULVERT CROSS-SECTION
NTS

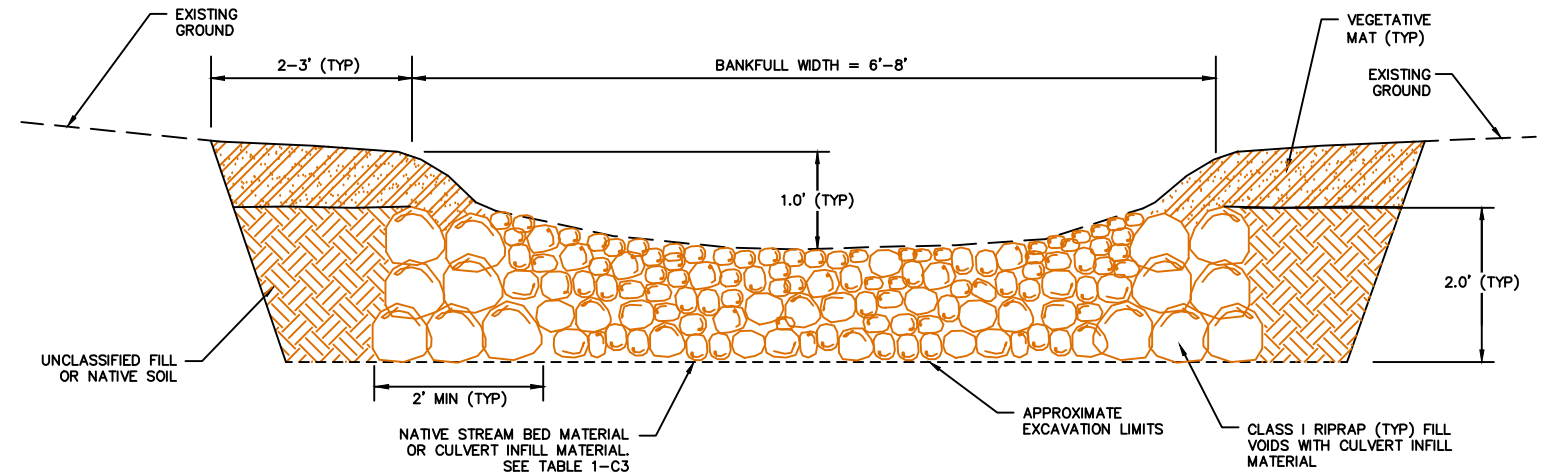

3
21
CONSTRUCTED BANK

1	RS	1/17/13	PLAN UPDATES BY DOWL HKM
NO.	BY	DATE	REVISION DESCRIPTION

DRAWN	DESIGNED	CHECKED
APPROVED	DATE	PROJECT

State of Alaska Department of Transportation
and Public Facilities - Haines, Alaska
Haines Highway - MP 3.5 to 25.3



Cannery Creek Fish Passage
Improvements Project
Mud Bay Road

SHEET

21 OF 21

APPENDIX E

Proposed Culvert Upgrades

Appendix E – Essential Fish Habitat
Haines Highway Proposed Culvert Upgrades (Preliminary)

Fish Pipe	Sheet Number	Station CL	ADFG Catalog	Stream Name	Fish Species	Existing Conditions	Proposed Culvert Replacement (Tier 1 or Tier 2)
FP-01	2	222+55	115-32-10250-2004	Unnamed	Coho, Dolly Varden	48" CMP	Tier 1; 95"x67" Aluminium Pipe Arch
FP-02	2	229+23	115-32-10250-2006	Schnabel	Coho, Dolly Varden, Cutthroat trout	24" CMP	Tier 1; 60" CMP
FP -33	2	232+19 to 231+68	115-32-10250-2006	Schnabel	Coho, Dolly Varden, Cutthroat trout	24" CMP	Tier 1; 60" CMP
FP-03	2	240+40	115-32-10250-2006-3003	Unnamed	Coho, Dolly Varden, Cutthroat trout	24" CMP	Tier 1; 60" CMP
FP-34	2	244+90 to 244+64	115-32-10250-2006	Schnabel	Coho, Dolly Varden, Cutthroat trout	24" CMP	Tier 1; 60" CMP
FP-04	2	245+31	115-32-10250-2008-3004	Unnamed	Coho, Dolly Varden, Chinook, Cutthroat trout	36" CMP	Tier 1; 60" CMP
FP-05	2	248+45	115-32-10250-2006	Schnabel	Coho, Dolly Varden, Cutthroat trout	24" CMP	Tier 1; 60" CMP
FP-06	4	292+92	115-32-10250-2014	Unnamed	Coho, Chinook, Dolly Varden,	Two 24" CMPs	Tier 1; 75"x55" Aluminium Pipe

Appendix E – Essential Fish Habitat
Haines Highway Proposed Culvert Upgrades (Preliminary)

Fish Pipe	Sheet Number	Station CL	ADFG Catalog	Stream Name	Fish Species	Existing Conditions	Proposed Culvert Replacement (Tier 1 or Tier 2)
					Cutthroat trout		Arch
FP-07	4	314+74	Un-cataloged Stream	Unnamed	Unknown	24" CMP	Tier 1; 60" CMP
FP-08	5	319+18	115-32-10250-2016	Unnamed	Coho, Chinook, Dolly Varden	36" CMP	Tier 1; 81"x59" Aluminium Pipe Arch
FP-09	5	324+83	115-32-10250-2020	Seven Mile Creek	Coho, Dolly Varden	48" CMP	Tier 1; 95"x67" Aluminium Pipe Arch
FP-10	6	349+96	Un-cataloged Stream	Unnamed	Coho, Dolly Varden	24" CMP	Tier 1; 48" CMP
FP-11	6	367+48	115-32-10250-2022	Unnamed	Coho, Dolly Varden, Cutthroat trout	24" CMP	Tier 1; 48" CMP
FP-12	7	383+20	115-32-10250-2024	Lily Pad Creek	Coho, Dolly Varden	36" CMP	Tier 1; 48" CMP
FP-14	10	483+78	115-32-10250-2028	Nine 1/2 Mile Creek	Coho, Dolly Varden	48" CMP	Tier 1; 95"x67" Aluminium Pipe Arch
FP-15	10	513+82	115-32-10250-2030-3002	Ten Mile Creek	Coho, Pink, Chum, Dolly Varden	36" & 24" CMPs	Tier 1; 151"x89" Aluminium Pipe Arch
FP-16	11	532+23	115-32-10250-2030	Ten Mile Creek Slough	Coho, Steelhead	24" CMP	Tier 1; 60" CMP
FP-17	13	590+75	115-32-10250-2032	Eleven 1/2 Mile Creek	Coho, Dolly Varden,	Two 24" CMP	Tier 1; 72" CMP

Appendix E – Essential Fish Habitat
Haines Highway Proposed Culvert Upgrades (Preliminary)

Fish Pipe	Sheet Number	Station CL	ADFG Catalog	Stream Name	Fish Species	Existing Conditions	Proposed Culvert Replacement (Tier 1 or Tier 2)
					Cutthroat trout		
FP-19	14	648+90	115-32-10250-2040	13 Mile Creek	Coho, Chinook, Pink, Dolly Varden, Cutthroat trout	36" CMP	Tier 1; 8'-10" by 6'-1" arch pipe
FP-20	15	654+20	115-32-10250-2040	13 Mile Creek	Coho, Chinook, Pink, Dolly Varden, Cutthroat trout	36" CMP	Tier 1; 8'-10" by 6'-1" arch pipe
FP-21	15	656+80	115-32-10250-2042	13 Mile Creek tributary	Coho	New Crossing	Tier 1 or Tier 2; design to be completed
FP-22	16	711+75	115-32-10250-2044	Fourteen Mile Creek	Coho, Chinook, Dolly Varden	Two 36" CMP	Tier 1; 12'-7" by 8'-4" arch pipe
FP-23	17	738+25	115-32-10250-2046	Unnamed	Coho, Chinook, Dolly Varden	24" CMP	Tier 1; 7'-3" by 5'-3" arch pipe
FP-24	18	768+75	Un-cataloged Stream	Unnamed	Coho, Chinook, Dolly Varden	36" CMP	Tier 1; 3.5' diameter CMP
FP-25	18	772+10	11-32-10250-2050	Unnamed	Coho, Shinook, Dolly Varden	24" CMP	Tier 1 or Tier 2; design to be completed

Appendix E – Essential Fish Habitat
Haines Highway Proposed Culvert Upgrades (Preliminary)

Fish Pipe	Sheet Number	Station CL	ADFG Catalog	Stream Name	Fish Species	Existing Conditions	Proposed Culvert Replacement (Tier 1 or Tier 2)
FP-26	21	871+10	115-32-10250-2060-3012-4001	Moosepaddle Creek	Coho, Chinook, Chum, Dolly Varden	6'-1" by 4'-7" arch pipe	Tier 1; 11'-7" by 7'-5" arch pipe
FP-27	22	887+60	115-32-10250-3011	Horse Farm Creek	Coho, Pink, Dolly Varden	Two 36" CMP	Tier 1; 9'-4" by 6'-3" arch pipe
FP-28	24	963+95	Un-cataloged Stream	Unnamed	Coho, Dolly Varden	8'-2" by 5'-9" arch pipe	Concrete box 19' x 14'
FP-29	24	975+20	Un-cataloged Stream	Unnamed	Coho, Dolly Varden	9'-9" by 6'-9" arch pipe	Concrete box 19' x 14'
FP-30	28	1103+00	115-32-10250-2070	21 1/2 Mile Creek	Coho, Chum, Dolly Varden	36" CMP	Tier 1; 7'-3" by 5'-3" arch pipe
FP-31	30	1180+50	Un-cataloged Stream	Unnamed	Coho, Dolly Varden	13' CMP	Concrete box 19' x 14'
FP-32	31	1188+05	Un-cataloged Stream	Unnamed	Coho, Dolly Varden	8'-2" by 5'-9" arch pipe	Concrete box 19' x 14'

APPENDIX F

Bank Stabilization Structures

MEMORANDUM

State of Alaska

Department of Transportation & Public Facilities
Design and Engineering Services – Southeast Region
Preconstruction / Materials

TO: Greg Lockwood, PE
Project Manager

DATE: November 29, 2013

THRU: Bruce Brunette, PE
Materials Engineer



TELEPHONE NO: 465-4441

FAX NUMBER: 465-3506

FROM: Robert Trousil, PE
SE Region Hydraulics
Engineer



SUBJECT: Technical Memo
Haines Highway
MP 3.5 to MP 12
Bank Stabilization Structures

Introduction

The first phase of the Haines Highway 3.5 to 25.3 Project proposes to construct transportation improvements on approximately 8.5 miles of highway. These improvements include road realignment, drainage upgrades, repaving, and bank armoring.

The highway is considered to be critical infrastructure. Critical infrastructure includes bridges, guide banks and other river training works, and facilities such as single access roadways or roadways where there is concern for stream erosion problems. The Haines Highway is considered critical infrastructure by the State of Alaska.

The highway is an important transportation corridor, providing year-round access to the town of Haines, the terminus of the highway, and other nearby communities. Additionally, the Haines Highway is one of two major highways connecting Southeast Alaska to the continental highway system via the Alaska Highway and the Alaska Marine Highway System. In addition to being an international transportation corridor, this highway also provides access to a variety of beneficial uses, including wildlife viewing, sport fishing, and many other recreational opportunities.

Between MP 3.5 and MP 12.0, approximately 6.5 miles of the existing highway alignment are located adjacent to the Chilkat River. Previous upgrades to the highway were conducted 34 years ago (1979) between MP 4.0 and MP 14.0, at which time the road was re-graded and paved. Modifications and upgrades to highway drainage were also conducted.

The proposed improvements to the Haines Highway would require the installation/upgrade of approximately 10,950-lf of bank stabilization revetments associated with critical infrastructure. This memorandum provides guidance and preliminary recommendations with respect to bank stabilization methods to be considered for this project. Objectives, design concepts, and structure types are presented based on field observations, agency discussions, review of written comments Alaska Department of Transportation & Public Facilities (ADOT&PF) received on the Environmental Assessment, and consideration of the general hydraulic and hydrologic conditions that exist in the Chilkat and other river systems in the area. Field review of existing bank stabilization structures, including the engineered log jam wood revetment located at the village of Klukwan, and river barbs installed in 2006 adjacent to the Klehini River, are presented.

Opportunities to enhance existing river bank habitat conditions, the identification of long term locations for fish wheels operated by the Alaska Department of Fish and Game, (ADF&G), and bank stabilization options, used individually or in combination, are presented.

Chilkat River Hydraulics/Hydrology

The Chilkat River is a broad, dynamic, glacially-fed fluvial system consisting of multiple channels within an extensive floodplain. The drainage area, at the confluence of the Chilkat and Klehini Rivers near Klukwan, is approximately 791-square miles, (figure 1). Near the Haines airport the drainage area increases to 1,602-square miles.

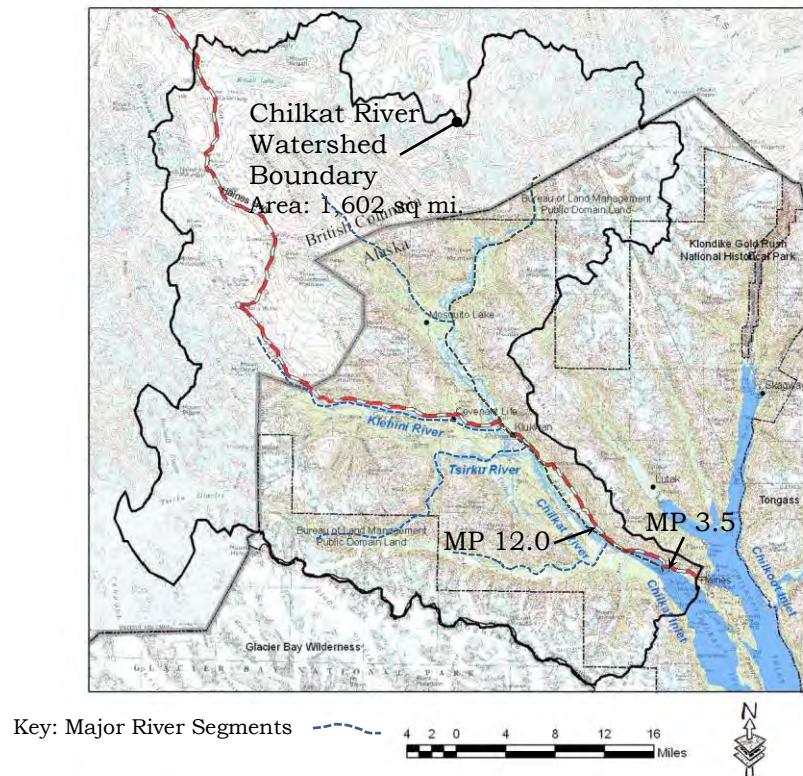

Figure 1. Chilkat River Watershed, major river sections, and project limits. (Watershed map courtesy DOWL, 2009).

Five (5) major river sections were identified and measured within the Chilkat River watershed shown in figure 1. Measurement of each of these major river reaches was made in an attempt to generally quantify the available river bank habitat that exists. Although a minimum of two banks per reach are accounted for, many river sections have multiple channels and therefore multiple river bank configurations. Sub-tributary riverine systems are also not included, thus, the river bank lengths presented in Table 1 are likely to be significantly understated, perhaps as much as a factor of two (2).

Table 1. Estimated length of river bank available as habitat, Chilkat River Watershed.

River Section	Total length of River Bank, (miles) ⁽¹⁾
Chilkat River	107
Klehini River	40
Tsirku River	50
Chilkat Sub-basin ‘A’ (near Mosquito Lake)	46
Chilkat Sub-basin ‘B’ (opposite MP 10)	40
Total	283

The major river section lengths represent a minimum of 283 miles of river bank available for habitat. The Haines Highway project proposes to:

- *replace/upgrade* approximately 10,950-ft, (2.1 miles) of revetment;
- place 7,730-ft (1.5 miles) of riprap on top of existing riprapped embankments, and;
- place 3,220-ft (0.6 miles) of riprap *on currently non-riprapped banks*.

River substrate consists of coarse materials dominated by cobbles and gravels, with finer materials consisting of sands and silts. The channel is described as braided, and is characterized by high bank erosion rates and excessive deposition occurring as both longitudinal and transverse bars, with annual shifts of the channel bed.

The floodplain is broad, varying in width from 1,000-ft in the reaches of the river near Mile 24 to 1.1 miles near the Haines Airport. Adverse conditions associated with flood flows of both short and long duration include high sediment loading and changing channel configurations. Normal flows of the river can rapidly change to over-bank flow conditions, causing inundation within the numerous side channels that exist within and adjacent to the floodplain.

In addition, high bank erodibility, together with moderately steep river gradients, contributes to river instability. Despite these hydraulic conditions, it does not appear the Haines Highway has sustained flood related damage, due in large part to the adequacy of the bank stabilization revetments currently in place.

The floodplain is tidally influenced at a point near the downstream end of the Haines Airport, which is downstream from the beginning of the project. Large woody debris, prevalent across the entire floodplain, occasionally creates localized logjams, temporarily redirecting flow and influencing channel orientations.

In areas where the floodplain is broad, only small changes in flood flow depth may be realized even as flood discharge rates increase dramatically. However, erratic sediment transport and deposition often result in the natural formation of longitudinal levee structures that may locally confine flood flows and inhibit occupation of the available floodplain. Riverbanks are susceptible to erosion when flood flows become concentrated by these natural levee structures when they form on the fringes of the floodplain.

Anecdotal and gage information suggests the Chilkat River may have been flowing higher than bank full/ordinary high water for significant periods of time in 2013. Based on data recorded at USGS gage 15056500, (figures 2a and 2b) located at the Wells Bridge, the Chilkat River stage/flow from late-May to mid-September was between 124.0-ft and 127.2-ft, or 8,000 to 16,000 cubic feet per second (cfs) respectively. Review of station records, which began in February 2013, indicates a low flow stage value of 119.0-ft, or 400-cfs.

Ordinary high water, (OHW) is normally used as a marker for the application of certain revetment treatments, such as topsoil application and restorative plantings. Because of morphological variability's that redistribute flows across the broad floodplain on an annual basis, OHW at any single point of the Chilkat River is likely to be a range of values over time and thus may be difficult to define.

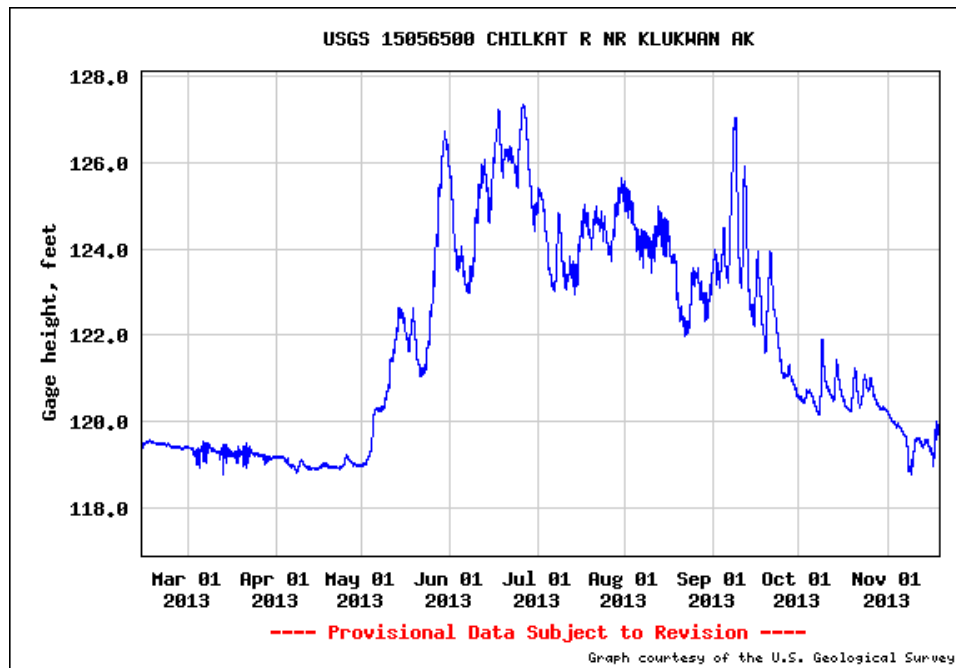

Figure 2a. Chilkat River stage recordings, February through November, 2013. (USGS, 2013)

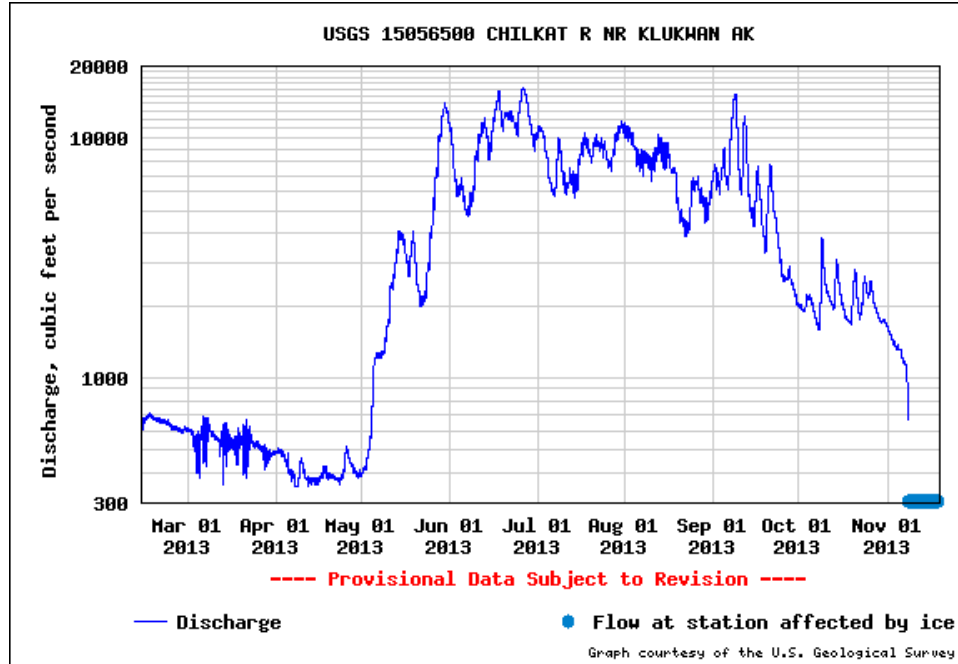

Figure 2b. Chilkat River discharge recordings, February through November, 2013. (USGS, 2013)

Bank Protection: Adaptability to Changes in the Chilkat River Fluvial System

River bank revetments along critical infrastructure are required to be designed and installed to meet the most demanding protection requirement that the bank will experience, whether the river is currently adjacent to critical infrastructure or not. Being an extremely dynamic river, any bank stabilization protection/habitat enhancement structure installed today may not be fully utilized for its intended purpose tomorrow.

With respect to bank stabilization efforts and their intended long term function, such efforts, at any given location within the Chilkat River system, are subject to the uncontrollable dynamics and complexities of the fluvial system. Such structures may be ‘online’ for one (1), or many years, and likewise may become ‘offline’ for short or long durations in the future. Likewise, fish habitat enhancements added adjacent to the highway bank infrastructure may be within the river flow patterns or not, depending on river dynamics.

River Bank Stabilization Objectives & Design Concepts

River bank stabilization is required to protect critical transportation infrastructure associated with the Haines Highway from the erosional effects of Chilkat River and its subsidiary channels. Simultaneously, habitat enhancement can be achieved by varying bank geometries, placement of large rock materials and rock weir/spurs, and the incorporation of strategically placed wood debris within the confines of stable bank protection structures.

Combinations of revetment types may enable the incorporation of unsecured woody materials into stable bank protection structures that can withstand the anticipated erosional effects and morphological uncertainties associated with the river system. Woody materials, used in combination with riprap, large rock, and rock weirs/spurs, would enhance habitat in the immediate vicinity of these structures, with the primary structures providing long term bank stability.

The four (4) revetment types anticipated to be used on the project, either individually or in combination, are described as follows:

- **Riprap** would be used to protect a wide range of infrastructure types exposed to the erosional effects of the Chilkat River. This includes the control of progressive stream and river bank erosion, and the protection of bridge piers and abutments, roadways, channels, and guide banks that are vulnerable to erosion. Historically, riprap materials have been used to create and enhance habitat within river systems when irregular bank geometries or larger sized materials are incorporated into revetment designs utilizing riprap.

The total length of *existing* riprapped embankment along the Haines Highway from MP 3.5 to MP 12.0 is 11,030-ft. New riprap replacement/upgrade lengths are estimated to be 10,950-ft; 7,730-ft of riprap would be placed on top of existing riprapped embankments and 3,220-ft of riprap would be placed on non-riprapped banks.

- **Rock Weir/Spur** structures are stable hydraulic obstructions which control near bank sediment deposition and scour. Rock weirs/spurs move the scour zone away from the bank, theoretically requiring *less* armoring of entire stream banks immediately downstream of these structures. Their intended function can become limited should river channel hydraulics change, such as the migration of the main channel to other portions of the floodplain.
- **Large Rock/Boulders**, in and of themselves, do not necessarily provide predictable and stable bank protection. However, using boulders, in conjunction with rock weirs/spurs and riprap provides below-water surface irregularities conducive to fish habitat enhancement.
- **Wood Material Revetments** are typically placed on the banks of a river, stream or auxiliary channel to enhance stream habitat and to inhibit bank erosion. They *obstruct* flow, influence bank configurations and channel alignment by decreasing flow velocity. Natural logjams form where large quantities of wood debris accumulate, usually at flow obstructions such as snags or bridge piers. Logjams can also form along meander banks or in channel avulsions.

The controlled use of woody materials, i.e. engineered log jams, for use as stand-alone bank revetments, could be used for river or auxiliary channel embankments that are not adjacent to critical infrastructure.

River Bank Stabilization Structures

Current bank stabilization configurations where the highway is adjacent to the Chilkat River and its auxiliary channels would consist of standard applications of riprap materials of variable class size. Bank armoring and stabilization structures would continue to be required to protect those sections of the Haines Highway that may be directly or indirectly influenced by the Chilkat River and its associated subsidiary channels. The primary structure type that meets the criteria of long term stability and protection of critical infrastructure is rock riprap materials.

Riprap revetments, of appropriate gradation, consistent with observed or anticipated hydraulic conditions, would be the primary stabilization structure used on the Haines Highway project. This type of revetment would be applied to all critical infrastructure associated with the project. Riprap revetment structures would be applied in varied geometries, and can be amended by any one of the following secondary stabilization/habitat enhancement structures.

1. **Rock weirs/spurs:** these are more hydraulically sophisticated structures and require evaluation of flow and channel conditions at each proposed installation site. Their primary use is to support fish wheel operation at pre-determined locations where the road is immediately adjacent to the Chilkat River. Secondarily, they can be used in combination with the controlled use of woody materials. At high water, a significant portion of the structure is submerged.
2. **Large rock, boulders 4 to 6-ft (or greater) in diameter:** large rock would be placed on or within primary bank stabilization structures. Their purpose is to create sub-surface hydraulic conditions that enhance fish habitat.
3. **Woody material revetments:** select woody materials, both large and small, can be incorporated within other primary structures. Any stand-alone wood revetment structure could only be installed along river reaches not adjacent to critical transportation infrastructure.

Design Objectives, Concepts, & Bank Stabilization Structure Type

The previously mentioned stabilization methods can be combined or installed either as stand-alone or combination bank revetments. The type of structure considered, and ultimately used to stabilize the river bank, requires hydraulic and biologic characterization of the site.

Identifying the most appropriate bank stabilization structure(s) will be based on evaluation of available design objectives, design concepts, and structure type, as generally described below:

Available *design objectives*:

- Restoration of riverine habitat
- Long term stability
- Preservation of riverine habitat
- Minimal maintenance
- Address the variability of fluvial morphologies

Available *design concepts*:

- Add river bank complexity
- Increase scour potential
- Decrease scour potential
- Encourage sediment deposition
- Decrease near bank flow velocity
- Create variable/irregular bank geometries

Available *structure types*:

- Riprap
- Rock weirs/spurs
- Large Rock/Boulders
- Woody Material
- Combination Structures

Agency input may identify additional design objectives, design concepts and bank stabilization structure types. It should be noted that the elements presented in each of the three (3) groups above are not presented in any order of importance or priority. Selection of a revetment structure, or combination thereof, will require prioritization of these elements based on where they are located and the level of protection required to protect critical transportation infrastructure. For example:

1. With respect to the protection of critical infrastructure, objectives may include measures to enhance habitat and decrease scour potential. The primary structural configuration design would be a stable section of riprap materials. Secondary structures, such as large boulders or rock weirs/spurs, provide variable geometries to the riprap face. Limited applications of unsecured woody materials may be applied to further enhance habitat.
2. In river reaches where critical transportation infrastructure is not at risk, greater consideration may be given to the addition/incorporation of woody materials within a framework of rock weirs/spurs and boulders to enhance habitat. Engineered wood revetments may be used as stand-alone structures, provided they can be shown to be stable and cost effective.

Table 1 identifies river reaches, their lengths, and the *preliminary* revetment treatment proposed. Revetments can be varied to accommodate anticipated changes in river orientations, their use in fish wheel placement, or as enhancements to habitat and biologic function. Additional seasonally sensitive field work will be required at each proposed location of any specialty hydraulic structure, such as fish wheels, that are adjacent to critical infrastructure.

Table 1. Bank stabilizing revetment locations, lengths, and types, Haines Highway, MP 3.5 to MP 12.0.

Revetment Locations				Proposed Structure Type				
Reach ID	Station Start	Station End	Distance, ft	Riprap	Boulders	Rock Weirs/Spurs	Woody Debris	Fish Wheel, (1)
1	262+00	264+00	200	x	x		x	
2	283+50	288+00	450	x	x		x	
3	296+00	301+00	500	x	x		x	
4	310+00	313+00	300	x	x		x	
5	335+06	337+06	200	x	x		x	
6	348+50	357+00	850	x, (2)				
7	359+50	362+00	250	x				
8	364+00	366+00	200	x				
9	370+00	376+00	600	x, (2)				
10	378+50	385+00	650	x, (2)		x, (3)		x, (4)
11	389+50	391+00	150	x				
12	406+00	409+00	300	x		x, (3)	x	
13	410+50	417+00	650	x, (2)	x		x	
14	427+50	469+50	4200	x, (2)		x		x, (4)
15	492+00	497+00	500	x, (2)	x	x, (3)	x	x
16	584+50	587+50	300	x	x		x	
17	609+00	614+50	550	x				
18	619+00	620+00	100	x	x		x	
Est Total Revetment Length:			10,950					

Notes: (1) Final fish wheel sites to be determined. Six (6) rock weir/spur installations are proposed.

(2) Geometric variation in these sections.

(3) Multiple rock weir/spur installations.

(4) Multiple fish wheel sites proposed in thees sections. STA 401+50 to 405+00 has a candidate fish wheel site.

Fish Wheel Installations

The Lynn Canal supports commercial, subsistence, and sport salmon fisheries that provide an economic base for the town of Haines. The ADF&G manages these fisheries, and depends on specific stock assessment programs to determine the strength of the returning salmon runs. On the Chilkat River, ADF&G currently operates two fish wheels to provide critical information on the strength and scope of the returning runs. Fish wheels (figure 3) provide information to assess the relative stock abundance and timing of all Pacific salmon in the Chilkat River, and with the opportunity to sample the fish for age, sex, and length data.

These data, in conjunction with data contributed from the Lynn Canal salmon marine stock composition program, are used to assess the health, productivity, and pattern of use of Chilkat River salmon stocks, to monitor trends and changes in stock abundances, and to evaluate established escapement goals. All of this information directly supports, and is critical to, the management of the Lynn Canal area commercial salmon drift gillnet and subsistence fisheries.

The fish wheel data provides information necessary to allow full use of the harvestable surplus of the Chilkat River salmon stocks, and assure that escapement goals are met.



Figure 3. Typical fish wheel installation adjacent to Haines Highway. Note cable anchoring system and log pole used to position the fish wheel away from the bank.

In August 2013, two fish wheels were in operation; one at 382+00, the second at 498+00. In recent years, several fish wheels sites were moved due to insufficient hydraulic conditions caused by changing river morphologies. In cooperation with ADF&G, ADOT&PF will design and install rock weir/spur combinations to support up to six (6) fish wheel sites. Table 1 above generally indicates reaches that are anticipated to be best suited for fish wheel operation. Table 2 provides ten (10) potential fish wheel sites identified by ADF&G.

Table 2. Proposed Fish Wheel Sites, Haines Highway, MP 3.5 to MP 12.0.

Fish Wheel Segment	Number of Fish Wheel Sites
379+00 to 391+00	2
401+50 to 405+00	1
410+50 to 416+00	1
428+00 to 446+00	3
448+50 to 464+00	2
494+50 to 500+00	1

Onsite evaluation of existing and anticipated hydraulic conditions at selected sites will be required. Designs will consider the installation of permanent anchoring systems at proposed fish wheel locations that facilitate their deployment and operation.

The Haines Highway road improvements project would positively address ADF&G commercial fishery monitoring concerns associated with fish wheel operation on the Chilkat River. The installation of the rock weir/spur structures would improve local hydraulic conditions that favor sustained fish wheel operation. These improvements may thus be candidates for mitigation credit since *additional* fish wheel sites are not needed to replace the existing sites, nor are these use-specific rock weirs/spurs needed for the proposed project.

Field Evaluation, Klukwan Wood Revetment Structure

A cursory field evaluation of the wood revetment structures (also known as engineered log jams), located in Klukwan was conducted August 29, 2013. The field visit included:

- observations of river flow conditions and stream morphologies at time of evaluation;
- identification of materials used;
- an evaluation of apparent bank stability, both upstream and downstream;
- identification of critical infrastructure in the immediate vicinity of the revetment and;
- a general examination of any repairs that may be required.

The purpose of the Klukwan wood revetment structure is to stabilize the stream bank and provide rearing and resting habitat for salmonids, (ADF&G, 2013). About 754 linear feet of riverbank has been treated with wood revetments at this location,

The observations made and recorded do not represent an exhaustive list of evaluation parameters that can be considered for these types of structures. No attempt was made to characterize, or indicate the adequacy of the revetment in providing biologic function with respect to fish or riverine habitat.

River morphologies in this reach of the Chilkat River are strongly influenced by the confluence of three major hydrogeologic features, (figure 4);

1. The Tsirku River and associated alluvial fan;
2. The main stem of the Chilkat River, and;
3. The large debris flow/alluvial fan opposite the Tsirku River fan.

As shown in figure 4, sediment loading from the Tsirku River, with opposing loading from the debris flow/alluvial fan complex located on the opposite bank, greatly constricts flow of the Chilkat River in this particular location.

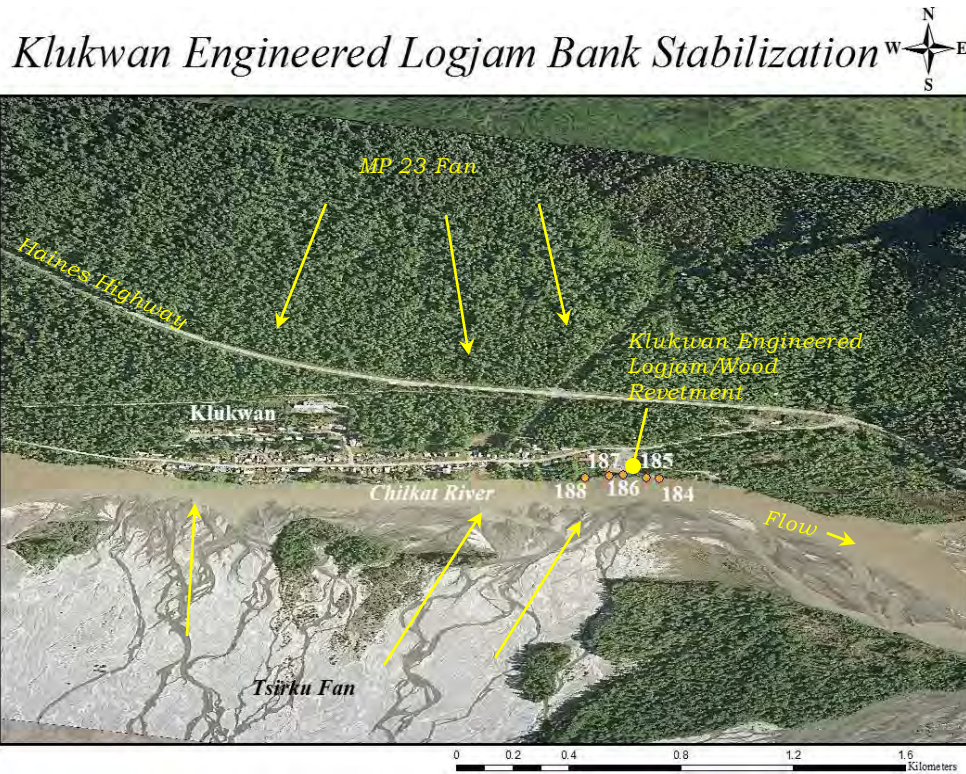

Figure 4. Aerial map of project area showing overall extent of logjam/wood revetment as indicated by numbered locations used for minnow trapping by AK DF&G. Arrows indicate direction of sediment transport for each respective Fan complex. (Photo courtesy ADF&G, September 2013).

These geomorphological configurations also make the north bank of the Chilkat River more vulnerable to persistent bank erosion. The installation of the wood revetment inhibits lateral migration of the river northward, which is the rivers natural tendency. Over the millennia, as Tsirku sediments feed the Chilkat main stem, the erosional capacity of the Chilkat River has to equal or exceed the deposition rate of bedload from the Tsirku complex to maintain the existing channel/thalweg elevations.

The wood revetment can be characterized as a lattice structure, comprised of logs of variable size lashed together with steel cabling and chain, (figure 5). Incorporated in the lattice along the face of the revetment are larger logs with intact root wads. The lattice is attached to vertically driven piles to prevent lateral and vertical (buoyancy induced) movement.



Figure 5. Klukwan wood revetment, looking downstream. (Courtesy ADF&G, 2013).

Figure 6 indicates that portion of the Klukwan wood revetment/engineered logjam exhibiting active slumping and erosion. The photo was taken near the southern, (downstream) end of the revetment near the Jilkaat Kwaan Cultural Heritage Center.



Figure 6. Wood/soil revetment structure along the Chilkat River, Klukwan, Alaska. Dashed lines indicate approximate locations of longitudinal cracking of the ground surface in the immediate area. Arrows indicate direction of bank slumping and material loss. (ADOT&PF August, 2013).

Figure 7 shows void formation and bank slumping near the upstream end of the wood revetment near a vertically installed piers. Significant slumping and depressions were noted in other locations when examining the soil surface within the wood revetment lattice. Their presence appears to be the result of the differential settlement and water induced migration of soils within the lattice structure. Surface erosion towards the river was evident.



Figure 7. Void formation and slumping at upstream end of wood revetment, Klukwan, Alaska, (ADOT&PF, August 2013).

Voids within the log lattice have allowed soil transport within and through the lattice. Surface depressions and longitudinal cracking were observed up to 20-ft from the front edge of the revetment. With respect to stability, initial field observations indicate bank instability (soil loss) as much as 20 to 25-ft from the river bank. The lattice structure itself appears to be intact.

Recommended Applications of Bank Stabilization Alternatives

Project objectives include the re-alignment of portions of the existing Haines Highway to meet Federal Highway design standards. The current alignment proposes to install, or otherwise refurbish, approximately 10,950-ft of bank stabilizing revetment.

Woody debris/materials could be placed on the downstream side of rock weir/spur structures, (except at fish wheel installations), or in between clusters of large rocks. These woody debris/materials may or may not be stable, however, their placement between stable bank protection structures should encourage longer term establishment of vegetative matter. Capture of other woody debris during higher water events would enhance near shore habitat.

Such composite structures mimic the existing bump-out features formed from smaller, historic debris flow fans, most notably at MP 7.15 and MP 8.85. Woody debris and sediment would have the tendency to accumulate in front of, shoreward, or even on top of, rock weir/spur structures. The major hydraulic function of rock weirs/spurs is to direct the scour zone away from the bank on the downstream side of the rock weir/spur.

Wood revetment structures, including engineered logjams, do not appear to be capable of controlling scour pools in perpetuity in fluvial systems like the Chilkat River. They can significantly increase the roughness of the river bank, lessening the erosional forces of water, provided they are strategically placed and adequately sized.

Wood revetments can also be used to satisfy environmental mitigation requirements if *bank roughing* is required to enhance habitat. Their use for that purpose would be limited to non-critical locations where habitat benefits are high. In infrastructure critical areas, they can be used in combination with stable revetment structures. Where bank stabilization is required, wood revetment structures, in and of themselves, would not provide adequate assurances of protection to the Haines Highway.

Designs of rock weirs/spurs for the Chilkat River would be more complex than existing Klehini River installations adjacent to the Haines Highway near the Canadian border. The orientation, appearance and overall hydraulic function of an appropriately designed rock weir/spur would be significantly different. Figure 8 shows a river training structure that is representative of what a rock weir/spur would look like. Although the structure shown in the photo is not properly oriented, (it should be angled in the upstream direction), its profile and taper are representative of what rock weir/spur structures would look like.



Figure 8. River training revetment (photo center) on the Klehini River closely resembles the configuration of a typical rock weir/spur structure proposed for the Haines Highway Project. Rock weirs/spurs would be larger and angled in the upstream direction. Note large boulders and woody debris in lower photo right. (ADOT&PF, August 2013).

Rock weir/spur designs are based on site specific hydraulic analysis, which includes modeling and field measurement at each proposed site. Preliminary evaluations indicate rock weir/spur structures would be constructed using Class III riprap materials.

A properly designed rock weir/spur can provide habitat improvements. Although these structures can be used at any location where revetments are required, they would primarily be installed at strategic locations to accommodate fish wheel installations. Appropriately spaced rock weirs/spurs can also be used to accommodate and retain placed and captured woody debris. Figure 9 shows a typical rock weir/spur configuration that would accommodate woody debris, primarily on the lee side of the rock weir/spur.

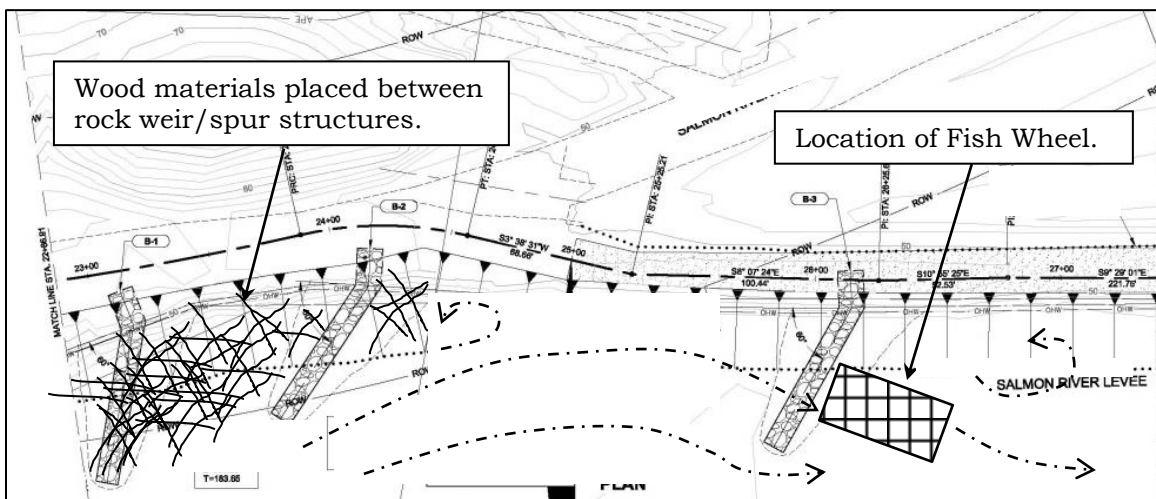

Figure 9. Closely spaced rock weirs/spurs (B-1 and B-2) retain woody debris that would be placed between them at time of construction. Capture of floating debris is enhanced by weir/spur orientation. Fish wheel location shown relative to rock weir/spur placement. River flow is from left to right. (from ADOT&PF, *Salmon River Road Levee Design*, 2013)

The installation of large boulders could either compliment other bank stabilization structures, or be used as stand-alone elements. Irregular riprap faces would be constructed as an alternative to conventional linear configurations.

Use of Bio-Engineered Stream Bank Protection

The State of Alaska can accommodate the use of bio-engineered stream bank protection measures in non-critical locations, particularly if the habitat benefits are high. Stand-alone wood revetments and engineered log jams are considered to be a bio-engineered alternative to bank stabilization.

In the future, ADOT&PF may consider bio-engineered methods at critical sites, but design methodologies must first mature to the point where Alaska specific design criteria exist, and most importantly, the durability of these structures has been proven over a wide range of hydraulic conditions found in the region. The risks to public safety and the costs to the state due to embankment loss or failure at points along critical infrastructure are substantial. Directives from ADOT&PF's Chief Engineer do not allow the installation of bio-engineered bank stabilization techniques to protect critical transportation infrastructure.

Although much has been accomplished in recent years regarding the design and installation of wood revetment/engineered logjams, the following is a brief summary of concerns, both general and specific, to the Chilkat River system:

- No long-term performance history exists. Durability questions remain as observed in existing wood revetment structures in the proximity of the project.
- These methods do not necessarily protect the submerged toe of the embankment.
- Wood revetments/engineered logjams are not self-healing when damaged, requiring relatively frequent maintenance.
- They have unpredictable maintenance costs while the State has limited maintenance budgets.
- Unknown performance with ice forces during ice breakup.

ADOT&PF is seriously concerned about the application of stand-alone bio-engineered bank stabilization structures installed adjacent to critical transportation infrastructure. The Haines Highway is an important transportation corridor, providing year-round access to the town of Haines, the terminus of the highway, and other nearby communities. It is also one of two major highways connecting Southeast Alaska to the continental highway system via the Alaska Highway and the Alaska Marine Highway System.

APPENDIX G

King and Coho Smolt Distribution in the Chilkat River

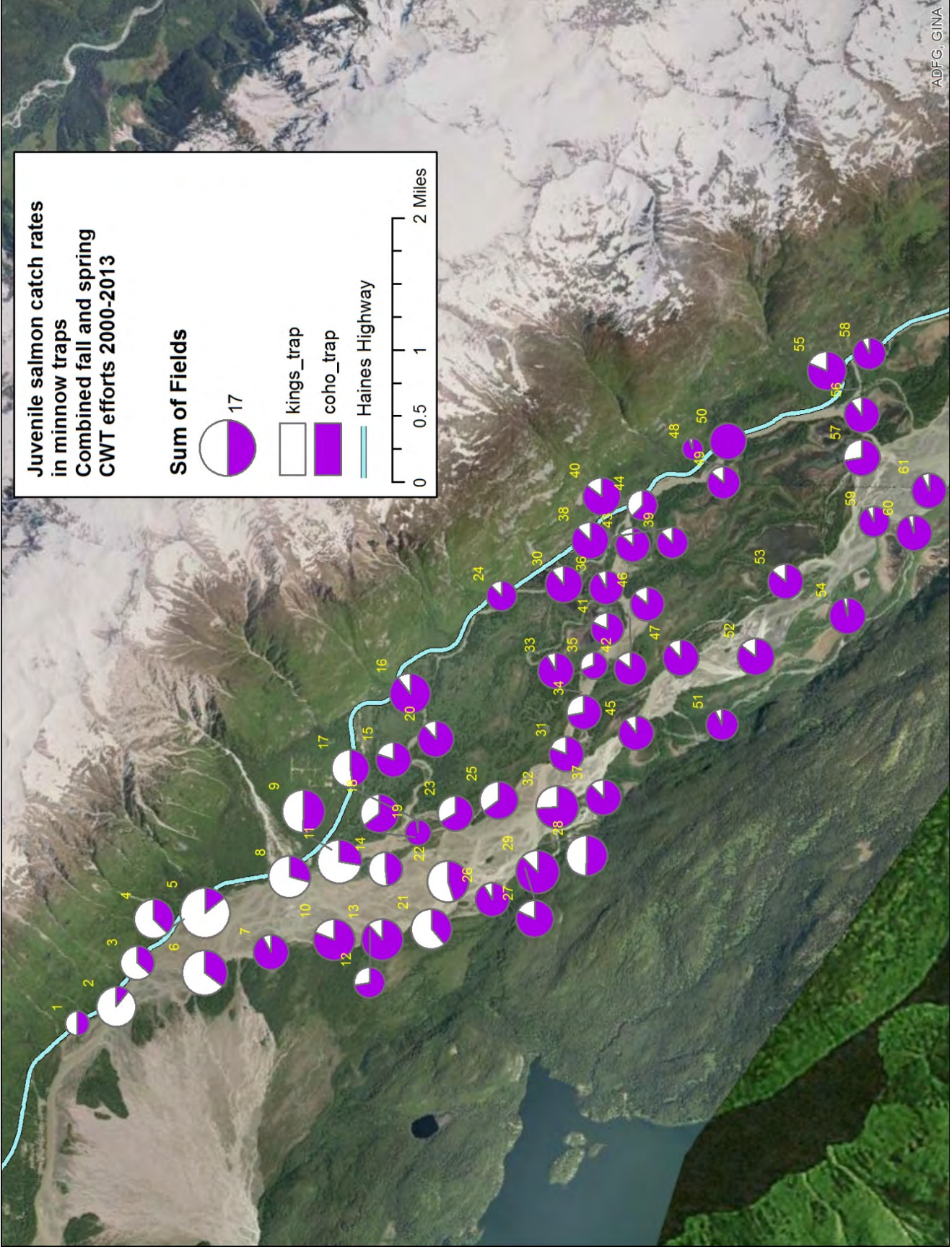

Trap Number	Trap Type	Sum of Fields
1	coho_trap	1
2	kings_trap	1
3	kings_trap	1
4	kings_trap	1
5	kings_trap	1
6	kings_trap	1
7	kings_trap	1
8	kings_trap	1
9	kings_trap	1
10	kings_trap	1
11	kings_trap	1
12	kings_trap	1
13	kings_trap	1
14	kings_trap	1
15	kings_trap	1
16	kings_trap	1
17	kings_trap	1
18	kings_trap	1
19	kings_trap	1
20	kings_trap	1
21	kings_trap	1
22	kings_trap	1
23	kings_trap	1
24	kings_trap	1
25	kings_trap	1
26	kings_trap	1
27	kings_trap	1
28	kings_trap	1
29	kings_trap	1
30	kings_trap	1
31	kings_trap	1
32	kings_trap	1
33	kings_trap	1
34	kings_trap	1
35	kings_trap	1
36	kings_trap	1
37	kings_trap	1
38	kings_trap	1
39	kings_trap	1
40	kings_trap	1
41	kings_trap	1
42	kings_trap	1
43	kings_trap	1
44	kings_trap	1
45	kings_trap	1
46	kings_trap	1
47	kings_trap	1
48	kings_trap	1
49	kings_trap	1
50	kings_trap	1
51	kings_trap	1
52	kings_trap	1
53	kings_trap	1
54	kings_trap	1
55	kings_trap	1
56	kings_trap	1
57	kings_trap	1
58	kings_trap	1
59	kings_trap	1
60	kings_trap	1
61	kings_trap	1

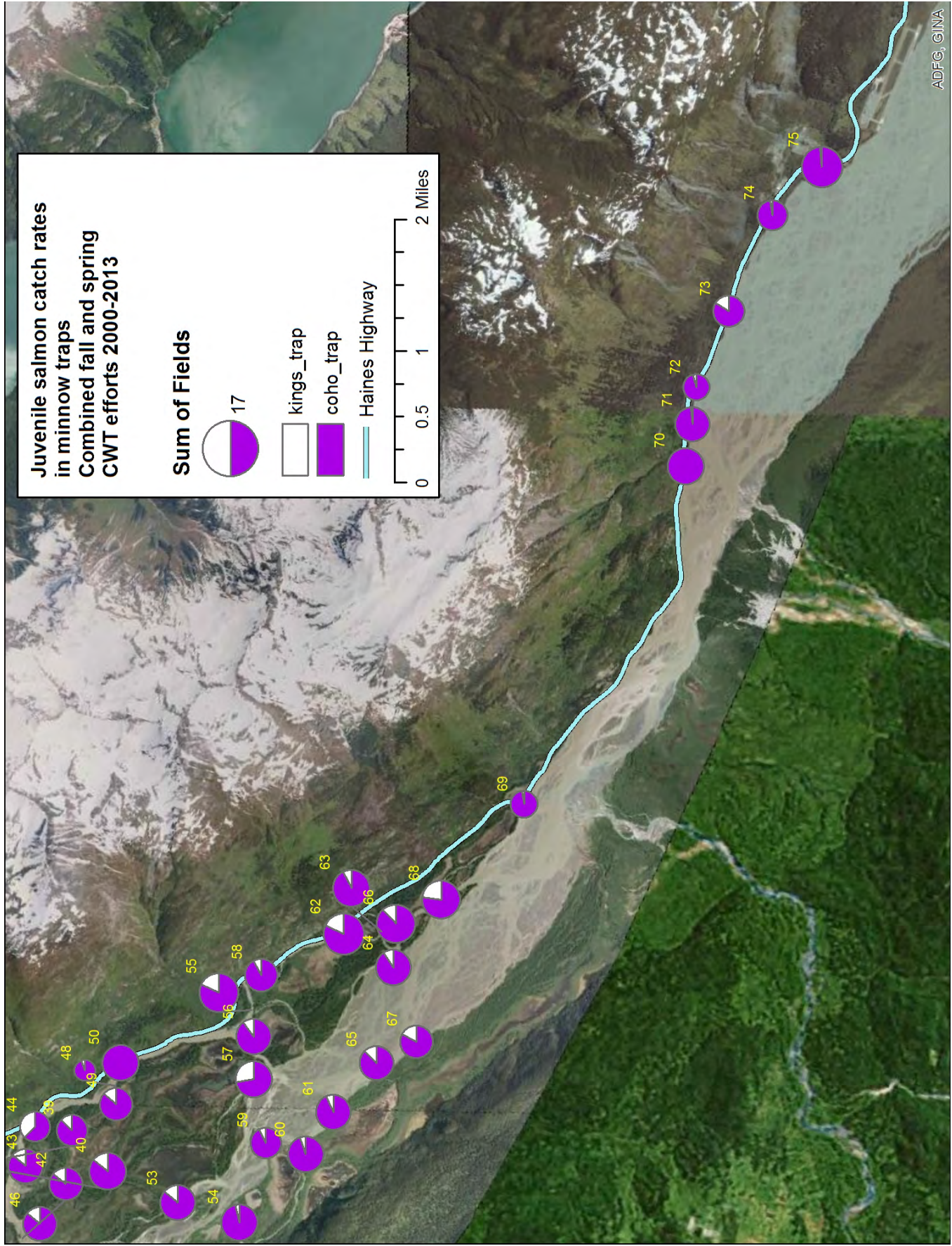

Chilkat River Fish Counts

Site number	Site name	Sum of Traps Checked	Sum of Kings	Sum of Coho
1	21 Mile	88	145	145
2	Tag Shack	150	1,177	144
3	Cliffs of Dover	65	263	151
4	20 Mile	237	1,255	762
5	Alder Island	389	4,600	767
6	Boneyard/Eagle Ghetto	2,961	21,768	11,745
7	Joe's/Mystery	548	308	3,454
8	19 Mile	299	2,062	851
9	Freezer	297	1,502	1,516
10	WTF/Max	1,095	2,019	8,379
11	Chicken/Door	984	7,737	2,984
12	Crucifix	166	244	627
13	Swimming Hole	1,395	1,528	11,691
14	Glory Daze	376	1,257	1,181
15	Dutch	1,348	1,819	7,395
16	Nettles	569	563	4,677
17	Conjunction	472	1,943	1,796
18	Confused	74	217	391
19	Beaver Biz	27	3	96
20	Area 51	176	149	1,112
21	Dust Chute	305	1,675	1,059
22	Eagle Nest	596	3,089	2,566
23	Sally	177	403	805
24	16 Mile	158	101	693
25	Biblical	934	2,619	4,845
26	Tree Stand	357	200	2,076
27	Power	1,562	2,147	9,810
28	King Willow	616	2,857	2,919
29	Kitty Slide	362	486	3,256
30	Skipper	904	762	6,092
31	Side Trickle	365	468	1,969
32	Mud Pit	806	2,123	5,981
33	Country Lane	547	326	3,560
34	Bayou	605	1,138	2,900
35	Ted's	115	141	317
36	Muddy Slough	942	493	5,478
37	Big Cat	920	788	5,739
38	Big Beaver	130	125	878
39	Gator Corner	98	65	456
40	Randy's	894	1,010	5,935

Chilkat River Fish Counts

Site number	Site name	Sum of Traps Checked	Sum of Kings	Sum of Coho
41	Sticklers	402	416	1,920
42	Penny Lane	343	297	1,775
43	GI	299	266	1,686
44	15 Mile	25	48	78
45	Ice Shelf	372	262	2,234
46	Snag Slough	693	612	3,817
47	Cottonwood	504	431	3,169
48	14 Mile	21	3	48
49	Punji	112	90	572
50	Boardwalk	40	2	289
51	Yellowstone	264	111	1,364
52	Motherlode	475	520	3,089
53	Spearfish	996	959	5,842
54	Ski	140	40	1,016
55	13 Mile Jam	1,131	1,736	7,771
56	Beaver Slide	292	217	1,828
57	Sahara	744	1,516	3,928
58	13 Mile Trailer	145	66	770
59	Foamy	133	55	653
60	Lewis & Clark	1,560	610	10,347
61	Moose Kill	372	176	2,336
62	Horseshoe	2,134	3,589	16,501
63	Nelbert	118	71	844
64	Bear Dunes	88	56	554
65	Right Bank	744	614	4,180
66	Icy Slough	1,541	1,499	11,234
67	Sidewinder	261	260	1,286
68	Mink Feet	194	370	1,231
69	10 Mile	52	6	198
70	7 Mile	19	0	143
71	Cambodia	193	21	1,255
72	2 Shacks	37	6	133
73	6 Mile	41	36	188
74	Schnabel's	164	24	825
75	Hooligan alley	245	32	2,220

